

UNIVERSITY PROPERTY

Revised
Preliminary Development
Plan W121-49

Prepared For:

U.C.P. INCORPORATED
Contact: Ben Anderson

October 26, 1999

APPROVED
BOARD OF SUPERVISORS
COUNTY OF SAN BERNARDINO
10/26/99 BY *M. Coleman*

TABLE OF CONTENTS

<u>SECTION</u>	<u>PAGE</u>
I. INTRODUCTION	1
A. BACKGROUND	1
B. PROJECT LOCATION	1
C. PROPOSED REVISIONS	5
D. COMPARISON BETWEEN APPROVED UNIVERSITY/CREST PD AND REVISED UNIVERSITY PD	6
E. RELATIONSHIP BETWEEN APPROVED UNIVERSITY/CREST PLANNED DEVELOPMENT (PD)	13
II. LAND USE	15
A. RELATIONSHIP TO SAN BERNARDINO COUNTY GENERAL PLAN ..	15
B. DEVELOPMENT REGULATIONS AND STANDARDS	15
III. CIRCULATION	22
A. RELATIONSHIP TO SAN BERNARDINO COUNTY GENERAL PLAN ..	22
B. PROPOSED CIRCULATION CONCEPT	22
IV. PUBLIC SERVICES AND FACILITIES	28
A. PUBLIC SERVICE AND FACILITY NEEDS	28
B. COMMUNITY FACILITIES	28
C. INFRASTRUCTURE	30
V. COMMUNITY DESIGN	41
A. LANDSCAPE CONCEPT	41
B. ARCHITECTURAL CONCEPT	47
C. GRADING CONCEPT	57
VI. CONSERVATION AND OPEN SPACE	61
A. PRESERVATION OF NATURAL RESOURCES	61
VII. SEISMIC HAZARDS AND PUBLIC SAFETY	62
A. SUMMARY OF SUBSURFACE ENGINEERING GEOLOGY INVESTIGATION	62
B. SAFETY FEATURES	62

CREDITS 63

APPENDICES 65

 A. LEGAL DESCRIPTION - UNIVERSITY (U.C.P)

 B. LANDSCAPE PLANT PALETTE

LIST OF EXHIBITS

<u>EXHIBITS</u>	<u>PAGE</u>
EXHIBIT 1	AREA MAP 2
EXHIBIT 2	VICINITY MAP 3
EXHIBIT 3	PROPERTY OWNERSHIP 4
EXHIBIT 4	UNIVERSITY/CREST PLANNING AREAS 7
EXHIBIT 5	REVISED UNIVERSITY PLANNING AREAS 8
EXHIBIT 6	EXISTING COUNTY LAND USE PLAN 16
EXHIBIT 7	PROPOSED LAND USE/CONCEPT LOT LAYOUT PLAN 20
EXHIBIT 8	TRAIL SYSTEM 23
EXHIBIT 9	CIRCULATION PLAN 24
EXHIBIT 10	STREET SECTION KEY MAP 25
EXHIBIT 10A	STREET CROSS-SECTIONS 26
EXHIBIT 10B	STREET CROSS-SECTIONS 27
EXHIBIT 11	ON-SITE WATER AND SEWER 32
EXHIBIT 12	OFF-SITE/REGIONAL WATER AND SEWER 33
EXHIBIT 13	ON-SITE STORM DRAINAGE 35
EXHIBIT 14	EXISTING SITE CONDITIONS 36
EXHIBIT 15	REGIONAL DRAINAGE AREAS 37
EXHIBIT 16	EXISTING UTILITIES 40
EXHIBIT 17	TYPICAL FRONT YARD LANDSCAPING/DRIVEWAY TREATMENTS 46
EXHIBIT 18	DETAILS/ARCHITECTURAL THEME: VICTORIAN 49
EXHIBIT 19	UNIQUE DETAILS/ARCHITECTURAL THEME: COUNTRY 50
EXHIBIT 20	UNIQUE DETAILS/ARCHITECTURAL THEME: BUNGALOW .. 51
EXHIBIT 21	UNIQUE DETAILS/ARCHITECTURAL THEME: RANCH 52
EXHIBIT 22	COMMERCIAL ARCHITECTURAL GUIDELINES 53
EXHIBIT 23	COMMERCIAL ARCHITECTURAL GUIDELINES 54
EXHIBIT 24	CONCEPTUAL GRADING PLAN 58
EXHIBIT 25	GRADING TECHNIQUES 59
EXHIBIT 26	LANDSCAPE TO ENHANCE SLOPES 60

LIST OF TABLES

<u>TABLES</u>	<u>PAGE</u>
TABLE 1	REVISED UNIVERSITY PD COMPARATIVE ANALYSIS 9
TABLE 2	REVISED UNIVERSITY PD PROJECT TABULATION 10
TABLE 3	REVISED UNIVERSITY PD STATISTICAL SUMMARY 11
TABLE 4	COMPARISON BETWEEN APPROVED UNIVERSITY AND REVISE UNIVERSITY 12
TABLE 5	REVISED UNIVERSITY PD STATISTICAL SUMMARY 14
TABLE 6	ARCHITECTURAL GUIDELINES 48

I. INTRODUCTION

A. BACKGROUND

The University/Crest project is a Planned Development (PD) for 1238 residential units, commercial, school, park and open space on 1,111 acres that was approved by the San Bernardino County Board of Supervisors in June, 1991. The previously approved PD provided the development framework for two separately owned properties - the Regents of the University of California (University) and the Caryn Development Company (Crest). The decision to combine and entitle the two properties under a single land use approval was made to ensure comprehensive planning and infrastructure efficiency.

One component of the University/Crest PD was a condition of approval for an open space easement over 675 acres of nearby unimproved property. The owner of the 675 acres was required to dedicate an easement to the County of San Bernardino for open space, recreational, scenic and maintenance purposes.

The project remained undeveloped for a number of years. Within this timeframe, the property earmarked for open space purposes was sold to individuals that were not connected with the University/Crest project. Eventually, the 675 acres was acquired by the Metropolitan Water District and has since been committed to permanent open space as environmental mitigation.

The removal of the area set aside for open space purposes altered the status of the existing University/Crest PD approval. Compliance with the conditions of approval became impossible and therefore revisions to the project are necessary if the development is to occur.

Following the loss of the open space, both development areas (University and Crest) were sold separately to new developers. UCP Inc. purchased the University portion and is presenting a revised project to the County. This Preliminary Development plan reflects the revisions to that previously approved project.

B. PROJECT LOCATION

The project is situated in the west portion of the West Valley Foothills Planning Area adjacent to the City of Rancho Cucamonga. The site is bounded on the north by the Crest portion of the previously approved PD, on the west by a Southern California Edison (SCE) utility corridor, on the south by Highland Avenue (future alignment of Route 30) and the east, south of Wilson Avenue, by Hanley Avenue. Exhibits 1 and 2 present the location of the project site and Exhibit 3 presents the property ownership.

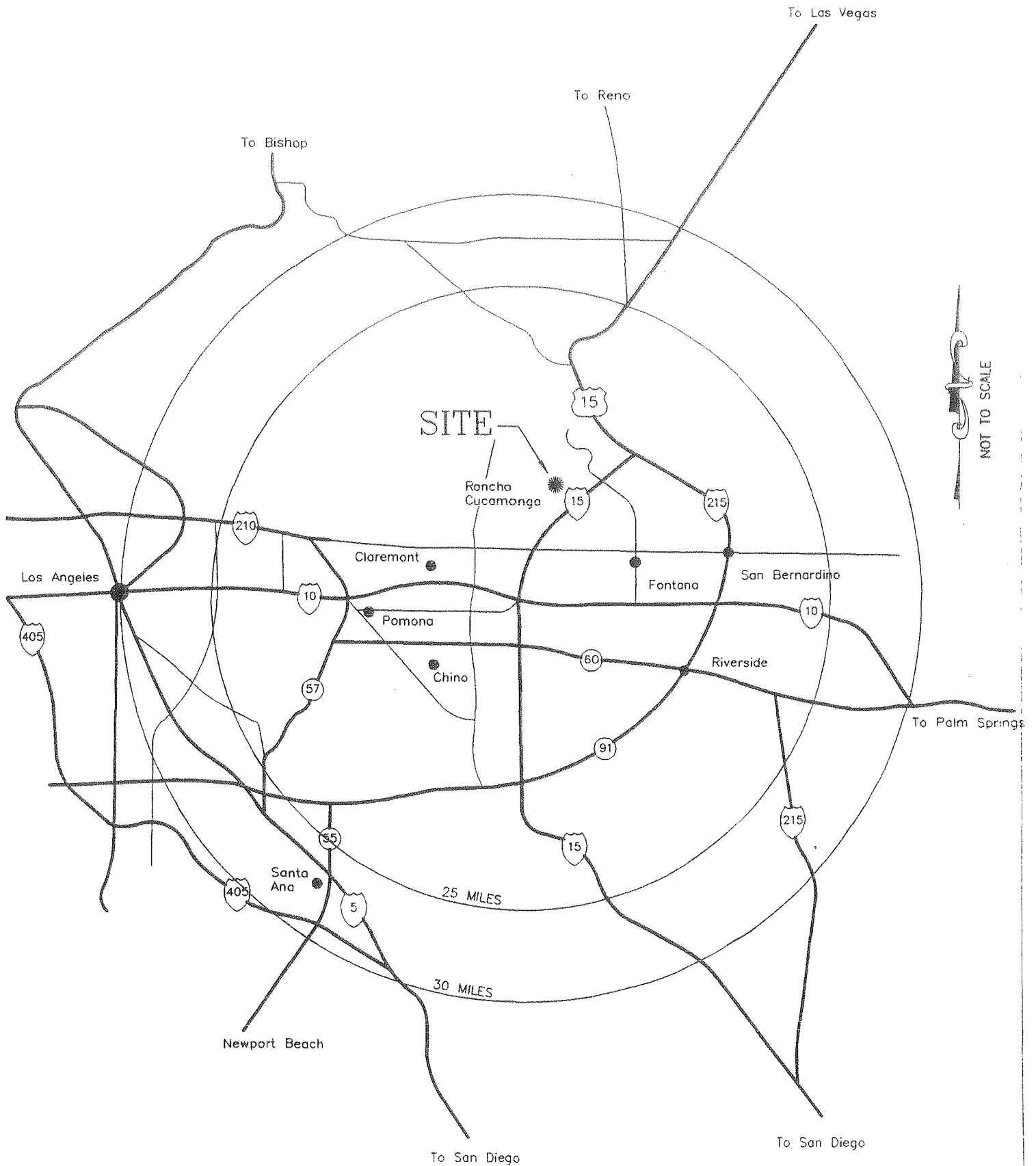

ALLARD ENGINEERING

EXHIBIT 1
AREA MAP

UNIVERSITY
PLANNED DEVELOPMENT

SITE

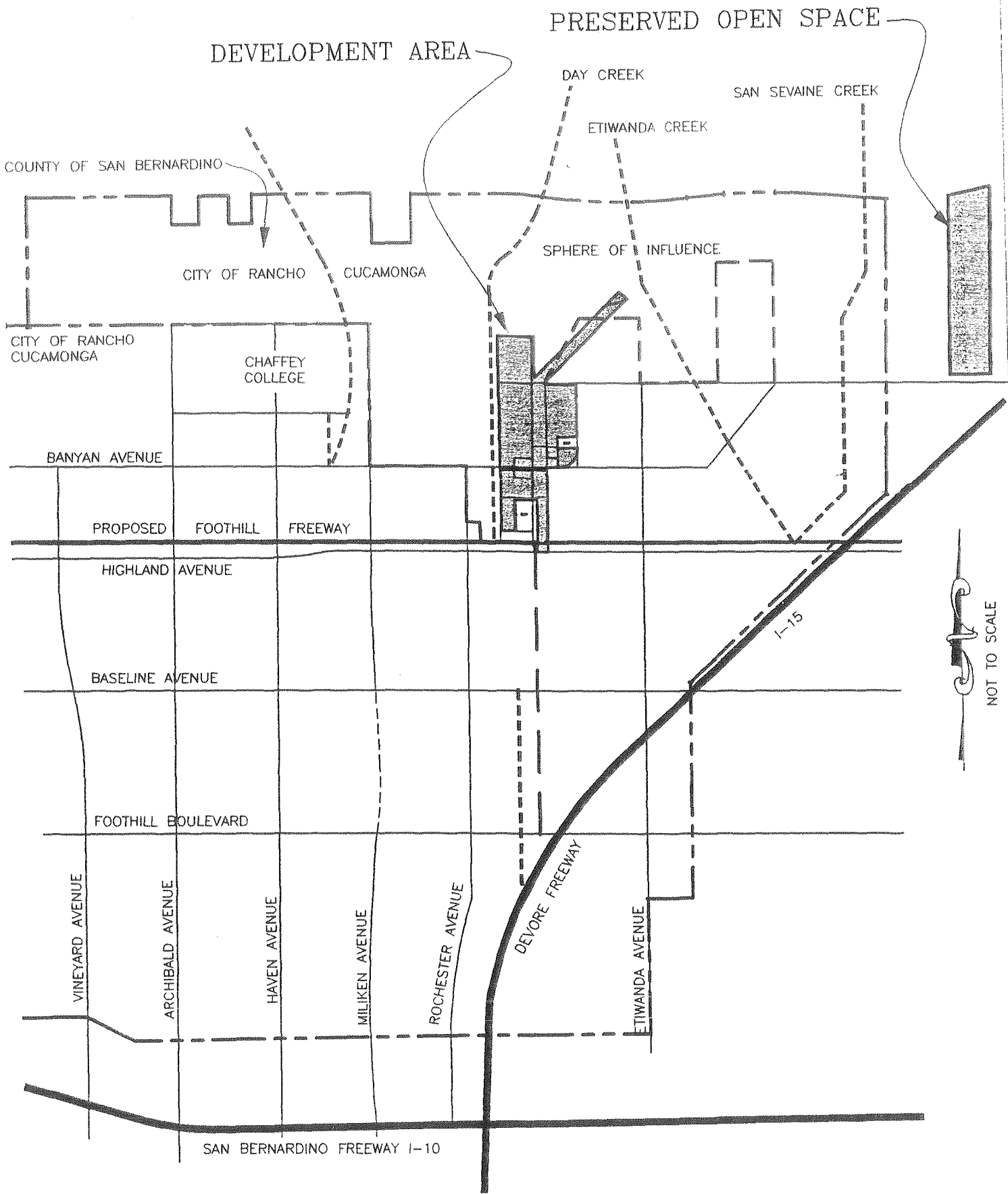

NOT TO SCALE



ILLARD ENGINEERING

EXHIBIT 2
CITY MAP

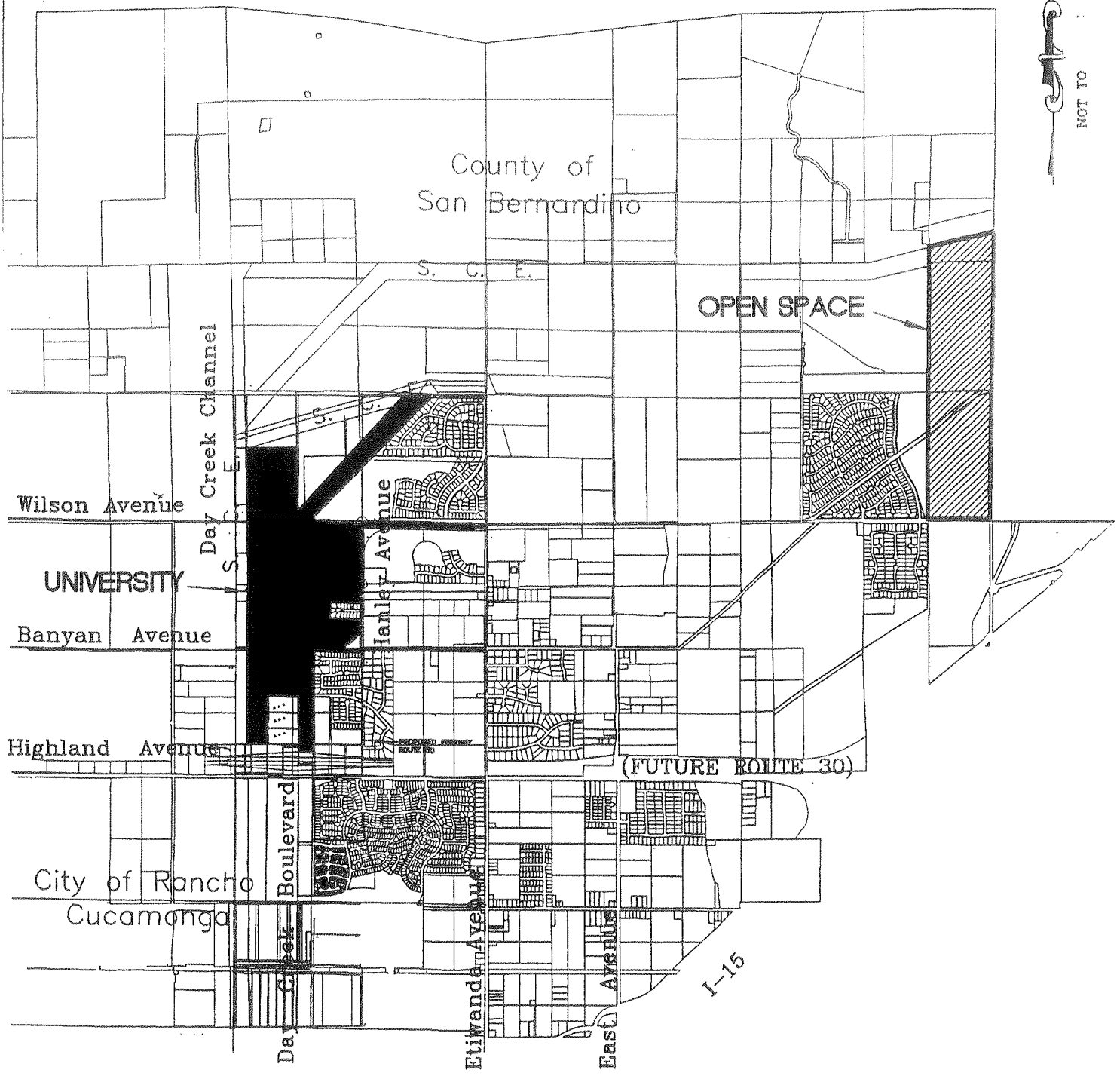
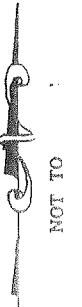
UNIVERSITY
PLANNED DEVELOPMENT



LEGEND

-  U.C.P. INCORPORATED
-  U.C.P. INC./CREST OPEN SPACE

ALLARD ENGINEERING

C. PROPOSED REVISIONS

The original PD was composed of 1238 residential units, commercial, school, park and open space on 1,111 acres. Included in the 1,111 acre total is 675 acres of nearby, undeveloped property that was to be reserved for permanent open space purposes. The revisions proposed by UCP are as follows:

- 1) Revise the University/Crest Preliminary Development Plan for 1238 residential units, commercial, school, park and open space on 1,111 acres. The revision will sever the University portion from the combined, previously approved University/Crest Planned Development and as such, the University project becomes a "stand-alone" PD.
- 2) Revise the University Final Development Plan for 578 residential units, commercial, school, park and 8 tentative tract maps on 186.8 acres by:
 - Adding 64 acres of former SCE property to the project;
 - increasing the proposed number of dwelling units from 578 to 685;
 - modifying the location of proposed commercial uses and adding a net 2 acres of commercial development; and
 - Increasing the size of the proposed school and park sites.
- 3) Revise 8 tentative tract maps on 186.8 acres. The revisions propose new street alignments, new lot designs and new lot sizes. All parcels are proposed to be a minimum 7,200 square feet.
- 4) Transfer to the County of San Bernardino, in fee, one half portion of a one hundred seventy-two (172) acres of off-site land for permanent open space purposes. Also provide an agreed upon amount to fund the long term maintenance of the off-site land.

In addition to the revision to the previously approved PD, the following land use processes are proposed to accomplish the project expansion:

- 1) Minor General Plan Land Use District Amendment. This process requests a change in the land use district designation from Institutional to Planned Development, 3 residential units per acre, on the 64 acres of former SCE property.
- 2) Two Tentative Tract Maps. These two subdivisions, TT15838 and TT15902, propose a total of 76 residential lots.

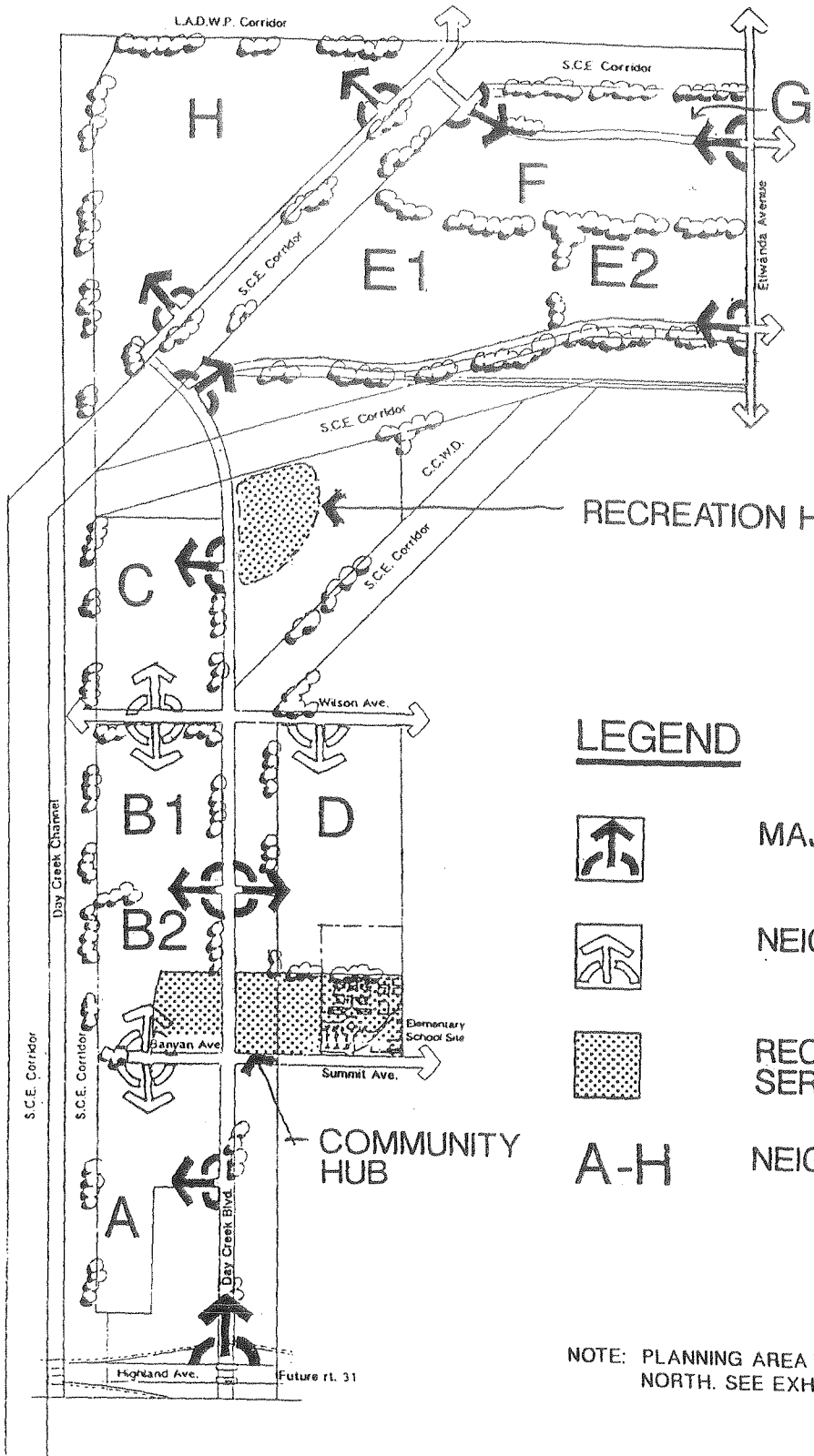

RECREATION HUB

LEGEND



MAJOR ENTRY



NEIGHBORHOOD ENTRY



RECREATION / COMMUNITY SERVICE HUB

A-H

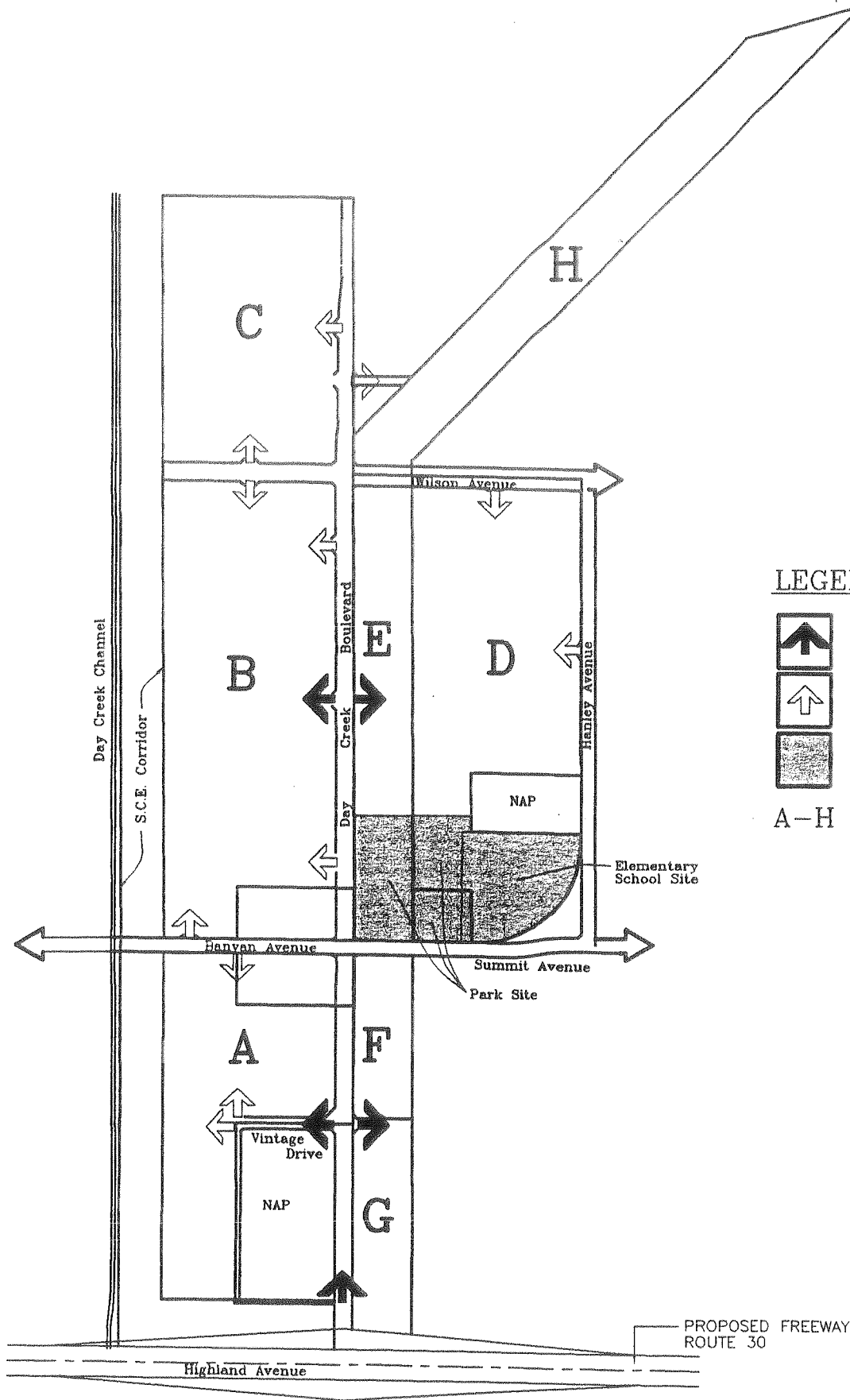

NEIGHBORHOOD AREAS

NOTE: PLANNING AREA I IS THE 675 ACRE PARCEL TO THE NORTH. SEE EXHIBITS 2 & 3 FOR ITS LOCATION.



NOT TO SCALE

LEGEND

-  MAJOR ENTRY
-  NEIGHBORHOOD ENTRY
-  RECREATION/
COMMUNITY HUB
- A-H NEIGHBORHOOD AREAS

PROPOSED FREEWAY
ROUTE 30

TABLE 1
APPROVED UNIVERSITY PROPERTY

TRACT	PLANNING AREA	NON- RESIDENTIAL ACRES	RESIDENTIAL ACRES	LETTERED LOTS ACRES	RESIDENTIAL LOTS	DENSITY	TOTAL ACRES
14522	A		10.13	0.33	37	3.54	10.46
14493	A		22.28	0.53	78	3.42	22.81
<i>Sub-total</i>	A	0	32.41	0.86	115	3.46	33.27
14494	B	12.66 ¹	13.46	0.91	52	1.92	27.03
14523	B		16.04	0.27	58	3.56	16.31
14495	B		20.72	0.71	74	3.45	21.43
<i>Sub-total</i>	B	12.66	50.22	1.89	184	2.84	64.77
14496	C		37.16	0.99	131	3.43	38.15
14497	D	4.66 ³	17.55	7.30 ²	68	2.3	29.51
14498	D		20.42	0.71	80	3.79	21.13
<i>Sub-total</i>	D	4.66	37.97	8.01	148	2.92	50.64
Grand Total	A-D	17.32	157.76	11.75	578	3.09	186.83

Notes:

1. Proposed Commercial Development
2. Proposed Park
3. Proposed School Site

TABLE 2
APPROVED CREST PROPERTY

TRACT	PLANNING AREA	NON-RESIDENTIAL ACRES	RESIDENTIAL ACRES	LETTERED LOTS ACRES	RESIDENTIAL LOTS	DENSITY	TOTAL ACRES
14606	E		54.73	8.49 ¹	185	2.93	63.22
14607	E		27.12	6.29 ¹	91	2.72	33.41
<i>Sub-total</i>	E	0	81.85	14.78	276	2.86	96.63
14608	F		17.53	0.09 ¹	51	2.89	17.62
14609	F		22.13	0.23 ¹	72	3.22	22.36
<i>Sub-total</i>	F	0	39.66	0.32	123	3.08	39.98
14610	G		11.7	4.77 ^{1,2}	20	1.21	16.47
14611	H		22.27	5.6 ¹	65	2.33	27.87
14612	H		60.1	5.78 ^{1,2}	176	2.67	65.88
<i>Sub-total</i>	H	0	82.37	11.38	241	2.57	93.75
Grand Total	E-H	0	215.58	31.25	660	2.67	246.83
<u>Approved University/Crest Project Totals</u>							
	A-H	17.32	373.34	43.0	1238	2.85	433.66

Notes:

1. Proposed Landscape Area
2. Proposed Drainage/Maintenance Area

TABLE 3
REVISED UNIVERSITY PROPERTY

TRACT	PLANNING AREA	NON-RESIDENTIAL ACRES	RESIDENTIAL ACRES	LETTERED ² LOTS ACRES	RESIDENTIAL LOTS	DENSITY	TOTAL ACRES
14522	A		9.73		34	3.49	9.73
14493	A		23.23		80	3.44	23.23
<i>Sub-total</i>	A	0	32.96	0	114	3.46	32.96
14494	B	4.41 ¹	18.1		58	2.58	22.51
14523	B		21.6		71	3.29	21.60
14495	B		20.65		57	2.76	20.65
<i>Sub-total</i>	B	4.41	60.35	0	186	2.87	64.76
14496	C	0	38.14	0	105	2.75	38.14
14497	D	8.0 ³	21.1	4.64 ²	80	2.37	33.74
14498	D		17.16		56	3.26	17.16
<i>Sub-total</i>	D	8.0	38.26	4.64	136	2.67	50.90
15838	E	0	14.64	5.36 ²	51	2.55	20.0
15902	F&G	10.54 ¹	7.19	0	25	1.41	17.73
	H		26.18		68	2.60	26.18
Total	A-H	22.95	217.72	10.0	685	2.73	250.67

Notes:

1. Proposed Commercial Development
2. Proposed Park
3. Proposed School Site

TABLE 4
COMPARISON BETWEEN APPROVED UNIVERSITY AND
REVISED UNIVERSITY

TRACT	PLANNING AREA	APPROVED UNIVERSITY LOTS	REVISED UNIVERSITY LOTS	CHANGE
14522	A	37	34	-3
14493	A	78	80	+2
<i>Sub-total</i>	A	115	114	-1
14494	B	52	58	+6
14523	B	58	71	+13
14495	B	74	57	-17
<i>Sub-total</i>	B	184	185	+1
14496	C	131	105	-26
14497	D	68	80	+12
14498	D	80	56	-24
<i>Sub-total</i>	D	148	137	-11
Total Units A-D		578	541	-37
15838	E	N/A	51	+51
15902	F&G	N/A	25	+25
	H	N/A	68	+68
TOTAL		578	685	+107

Table 5 presents a statistical profile of development by Planning Area. The land uses have been separated into six separate categories that reflect Buildings, Open Space, Roads, Parks, Schools and Commercial development. Table 5 also provides an estimate of total linear feet of new roadways and total project earthwork.

D. RELATIONSHIP OF THE REVISED UNIVERSITY PLANNED DEVELOPMENT WITH THE PREVIOUSLY APPROVED UNIVERSITY/CREST PLANNED DEVELOPMENT

The filing of the referenced revisions to the University/Crest Planned Development is the initial step in a process that, if satisfactorily completed, will replace the design, land use arrangement, policies, development standards and conditions of approval relating to the University portion of the University/Crest PD. For the Crest portion of the University/Crest PD to develop, a similar process that requests an amended approval of that segment of the project must be completed. Prior to initiating that process, the design, land use arrangement, policies, development standards and conditions the Crest portion of the University/Crest PD remain as previously approved.

As a component of the project, the revisions to the University/Crest PD includes the transfer of 172 acres of undeveloped off-site property to the County of San Bernardino. This off-site property has been acquired jointly by UCP and the new owners of the Crest properties and as such, is jointly offered as a substitute for the 675 acres of open space required in the University/Crest PD. In addition, both owners will participate in the funding for the maintenance of the site. When the Crest property is developed, that project will dedicate their fifty-percent participation in the 172 acres of donated open space and the agreed upon funding.

TABLE 5
REVISED UNIVERSITY PD STATISTICAL SUMMARY

PLANNING AREA	GROSS ¹ ACRES	RESIDENTIAL UNITS	LAND USES ²	ACRES	%	L.F.	GRADING (CUBIC YARDS)
Area A	32.96	114	Building	4.32	13	6,866	Cut 80,000
			Open Space	20.40	62		Fill 80,000
			Roads	8.24	25		
Area B	64.76	186	Building	7.04	11	11,787	Cut 190,000
			Open Space	36.78	57		Fill 190,000
			Roads	16.53	25		
			Commercial	4.41	7		
Area C	38.14	105	Building	5.72	15	7,287	Cut 125,000
			Open Space	22.88	60		Fill 125,000
			Roads	9.54	25		
Area D	51.09	136	Building	5.15	10	7,017	Cut 190,000
			Open Space	23.1	46		Fill 190,000
			Roads	10.01	20		
			Park	4.64	9		
			School	8	16		
Area E	20.0	51	Building	1.93	10	2,190	
			Open Space	8.74	43		Cut 37,000
			Roads	3.97	20		Fill 37,000
			Park	5.36	27		
Area F & G	17.73	25	Building	0.95	5.4	1,615	Cut 29,000
			Open Space	4.44	25		Fill 29,000
			Roads	1.80	10.1		
			Commercial	10.54	59.5		
Area H	26.18	68	Buildings	2.58	10	4,250	
			Open Space	17.02	65		Cut 125,000
			Roads	6.55	25		Fill 125,000
Total	250.67	685		250.67		41,012	

Notes:

All figures above are estimates and are subject to change during the Final Tract Map process.

1. All calculations in this table are expressed in gross acres, which include roadways, rights-of-way and open space, within Planning Areas A-G.
2. Land use is divided into six categories: Building, Open Space, Roads, Parks, Schools and Commercial. Building coverage is based on an average 1,650 S.F. footprint (includes garage). Road area is based on a curb measurement. Open space includes all area other than roads and building footprints.
3. Land Use percentages, Lineal feet of Street and Grading is estimated.

II. LAND USE

A. RELATIONSHIP TO SAN BERNARDINO COUNTY GENERAL PLAN

The revised University PD is designed to be consistent with the goals of the County's General Plan for this area which encourages that development be an extension of adjoining communities but not in competition as an urban core.

The subject site is located directly north of the Victoria planned community where lots range from 3,000 square feet to 7,200 square feet, and directly south of the Crest, a proposed planned community with lot sizes of approximately 9,000 square feet. To the west of the project is a 7,200 square foot development in the City of Rancho Cucamonga. The project site is currently designated for WF/PD-3/1 as shown in Exhibit 6.

The revised University PD proposes a development with a minimum of 7,200 square foot lots as shown in Exhibit 7.

B. DEVELOPMENT REGULATIONS AND STANDARDS

1. General Standards and Regulations

- a. Whenever the regulations contained herein conflict with the regulations of the Development Code of the County of San Bernardino, the regulations contained herein shall take precedence. Where a regulation is not covered, refer to the Land Use Development Code of the County of San Bernardino.
- b. Grading will be permitted within the project area outside an area of immediate development upon the securing of a grading permit.

During the site development, construction hours of operation shall be limited to between 7:00 a.m. and dusk, Monday through Saturday. No activities will be permitted outside these hours, including maintenance work on any equipment used in grading and/or construction unless a temporary waiver will be granted by the Building Division. No such waiver will be granted where such work is to be conducted adjacent to existing and occupied dwelling units except in cases of emergency as determined by the Building Official.

- c. Regardless of the provisions of this text, no construction shall be allowed within the project area except that which complies with all the provisions of applicable building and mechanical codes.

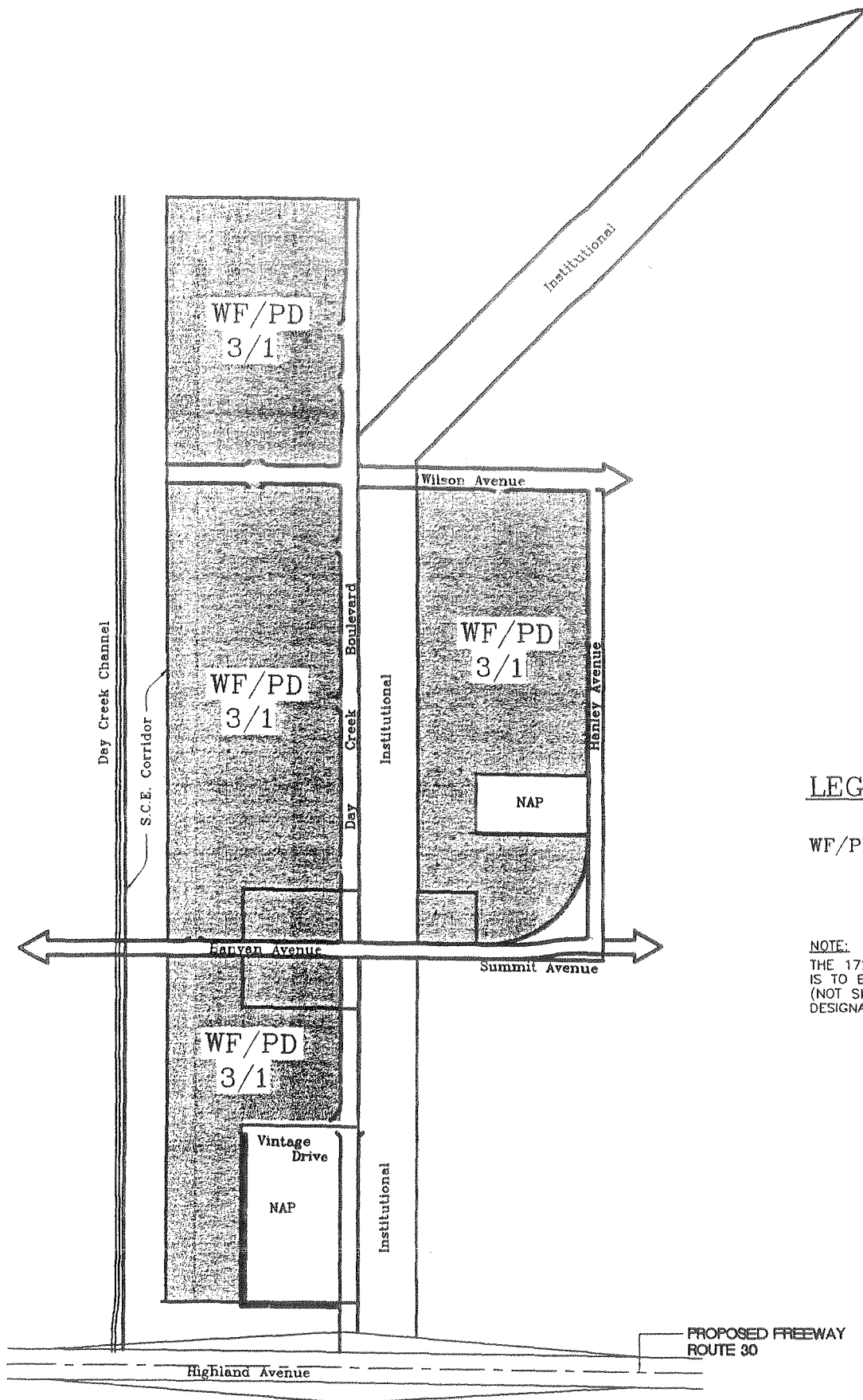

LEGEND

WF/PD-3/1 - WEST VALLEY FOOTHILLS
 PLANNED DEVELOPMENT
 3 UNITS PER 1 ACRE

NOTE:

THE 172 ACRE PARCEL TO THE WEST
 IS TO BE PRESERVED AS OPEN SPACE
 (NOT SHOWN ON THIS EXHIBIT) IS
 DESIGNATED WF/FW.

- d. Model homes, garages, and private recreation facilities may be used as offices for the sales of homes within a recorded tract and subsequent tracts as allowed by the San Bernardino County Development Code.

2. Residential Development Standards

- a. Temporary Uses Permitted (All subject to provisions of San Bernardino County Development Code).

- 1) Model homes, temporary construction offices, real estate office and signs.

- b. Permitted Uses

- 1) Single-family dwellings.
- 2) Open space, parks and trails.

- c. Accessory Uses Permitted

- 1) Garages and carports in compliance with the site development standards provided herein.
- 2) Fences, walls, patios, patio enclosures and trellises.
- 3) Swimming pools
- 4) Accessory uses and structures necessary or customarily incidental to a principal use permitted in this district are allowed subject to approval of the Building Official.

- d. Additional uses in accordance with the provisions of the San Bernardino Development Code, Sections 84.0401 through 84.0420.

e. Walls

Wall constructed as acoustical barriers along arterial and collector roadways shall be a minimum of six (6') feet in height as required by the project's acoustical study. All property line walls/fences shall be approximately six (6') feet in height and may exceed this as necessary for grading purposes. In such cases, they will be limited to seven (7') feet. Maximum heights of major entry features such as portals shall be as noted on the Final Development Plan. A maximum 3'6" wall shall be permitted within the front yard setback area. Such walls shall not be closer than four (4') feet to the nearest sidewalk.

f. Garage and Carport Placement

- See Already Answered Email*
- 1) Where garages/carports are entered from local streets and the garage doors face the street, the setback shall be a minimum of twenty (20') feet from the back of the sidewalk.
 - 2) Where garages/carports are entered from local streets and the garage doors do not face the street but are instead turned at right angles to the street (side entry garages) the setback shall be ten (10') feet minimum from back of sidewalk.

g. Site Development Standards:

- 1) Lot Area:

Single Family (SF 7,200)

- 2) Width:

Sixty (60') feet minimum, measured across building setback line of lot. Width may vary dependent upon lot size.

- 3) Coverage:

* Building: 40% maximum of lot area for building structures. Paving, driveways, patios, or pools shall not be calculated as part of building coverage.

4) Building Setbacks:

* a) Front Yard: Should be staggered with a minimum eighteen (18') feet with an average of 20 feet throughout the tract, as measured from the R.O.W.

* b) *No difference between corner side &* Fifteen (15') feet minimum building separation is required with minimum five (5') feet and ten (10') feet side yards measured from property lines.

c) Rear Yard: Fifteen (15') feet minimum.

5) Building Height

Two Story, thirty-five (35') feet maximum.

6) Parking Requirement

2 per dwelling

7) Dwelling Unit Size

a) One thousand two hundred (1,200) square feet minimum, not including garage or carport area.

b) Lot ratio: unless otherwise shown on the approved tentative tract maps, depth to width lot ratio shall not exceed 3:1.

8) Modifications to the Final Tract Maps for the University Planned Development, including but not limited to lot design or number of units within each tract, will be considered minor revisions as long as the overall permitted density for the project is not exceeded. These changes may be accomplished through the Revisions application process and will require no amendments to the Preliminary or Final Development Plans.

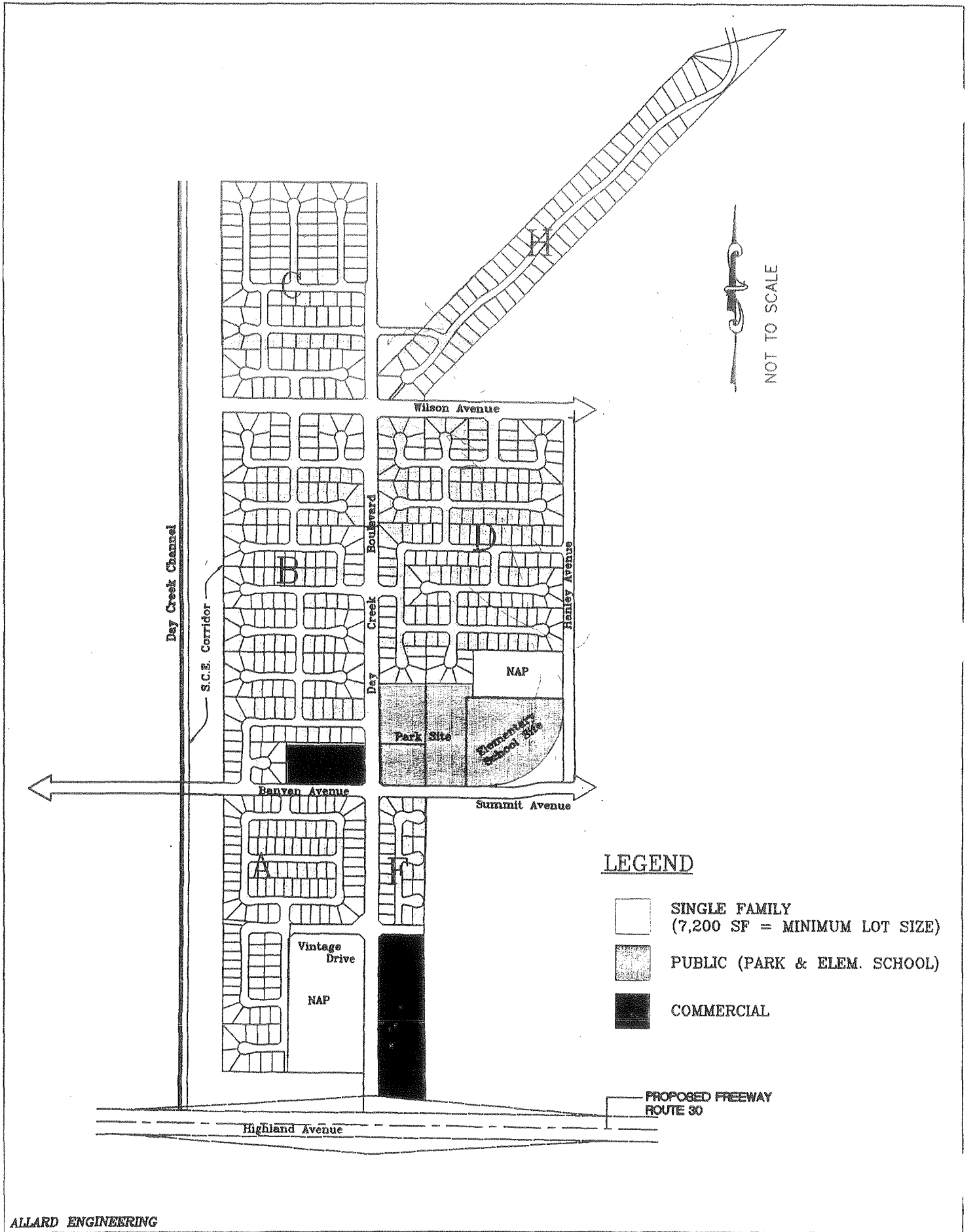

h. Metropolitan Water District (MWD)

An eighty (80') foot MWD right of way crosses the site. This project will conform to requirements established by MWD for improvements (i.e. roads, landscaping, etc.).

Minimum road improvements will need to occur within MWD; landscaping will be provided within the MWD corridor subject to MWD conditions.

3. Commercial Development Standards

Commercial development within the revised University PD shall conform to the standards of the San Bernardino County Development Code. The revised PD proposes two district commercial areas, the 4.4 acre commercial site located on the northwest corner of Day Creek Boulevard and Summit Avenue and the 10.5 acre site located on the northeast corner of Day Creek Boulevard and Route 30. The commercial site located at the northwest corner of Summit Avenue and Day Creek Boulevard is a neighborhood commercial site and therefore will be developed consistent with the allowable land uses and development standards articulated within Section 84.0340 Neighborhood Commercial (NC) Land Use District of the Development Code.

The commercial site located at the northeast of Day Creek Boulevard and Route 30 will provide service and highway oriented commercial uses and therefore should conform with the allowable land uses and development standards articulated in Section 84.0343, Highway Commercial (CH) Land District of the Development Code.

III. CIRCULATION

A. RELATIONSHIP TO SAN BERNARDINO COUNTY GENERAL PLAN

The proposed project responds to the Circulation Element of the County General Plan. Specifically, directive (3), Actions (A) and (C) require development to "adopt road standards that are compatible with those of adjoining communities" and to "coordinate the circulation system with the circulation goals of adjoining communities."

The circulation plan proposed by the revised University PD will provide residents access to roads which are compatible in character and standards of adjoining communities.

B. PROPOSED CIRCULATION CONCEPT



The circulation concept for the revised University PD includes provisions for vehicular circulation as well as a comprehensive trail system accommodating pedestrian, bicycles and equestrian activities. The backbone trail system is presented in Exhibit 8. An equestrian trail will be developed from north to south on the western portion of the project site, within the SCE easement. An additional and intersecting equestrian trail will be developed on the south side of both Wilson Avenue and Summit Avenue. An off-street bike trail will be developed on the south side of Wilson Avenue. A bike trail will also be accommodated within Summit Avenue.

The development of the University PD will establish a number of important circulation links within the sub-region transportation system. The ongoing construction of SR-30 will create a freeway interchange at Day Creek Boulevard. By constructing Day Creek Boulevard northerly to the northern property line, the University PD will establish this critical north-south arterial link. Additionally, the University project proposes to create an important east-west link by extending Banyon Street westerly beyond the property limits, bridging the Day Creek Channel and creating a link with the existing terminus of Rochester Street in the City of Rancho Cucamonga. This connection completes a component of the Rancho Cucamonga Circulation Element. The University PD will also complete other east-west roadways including Wilson Avenue and Summit Avenue.

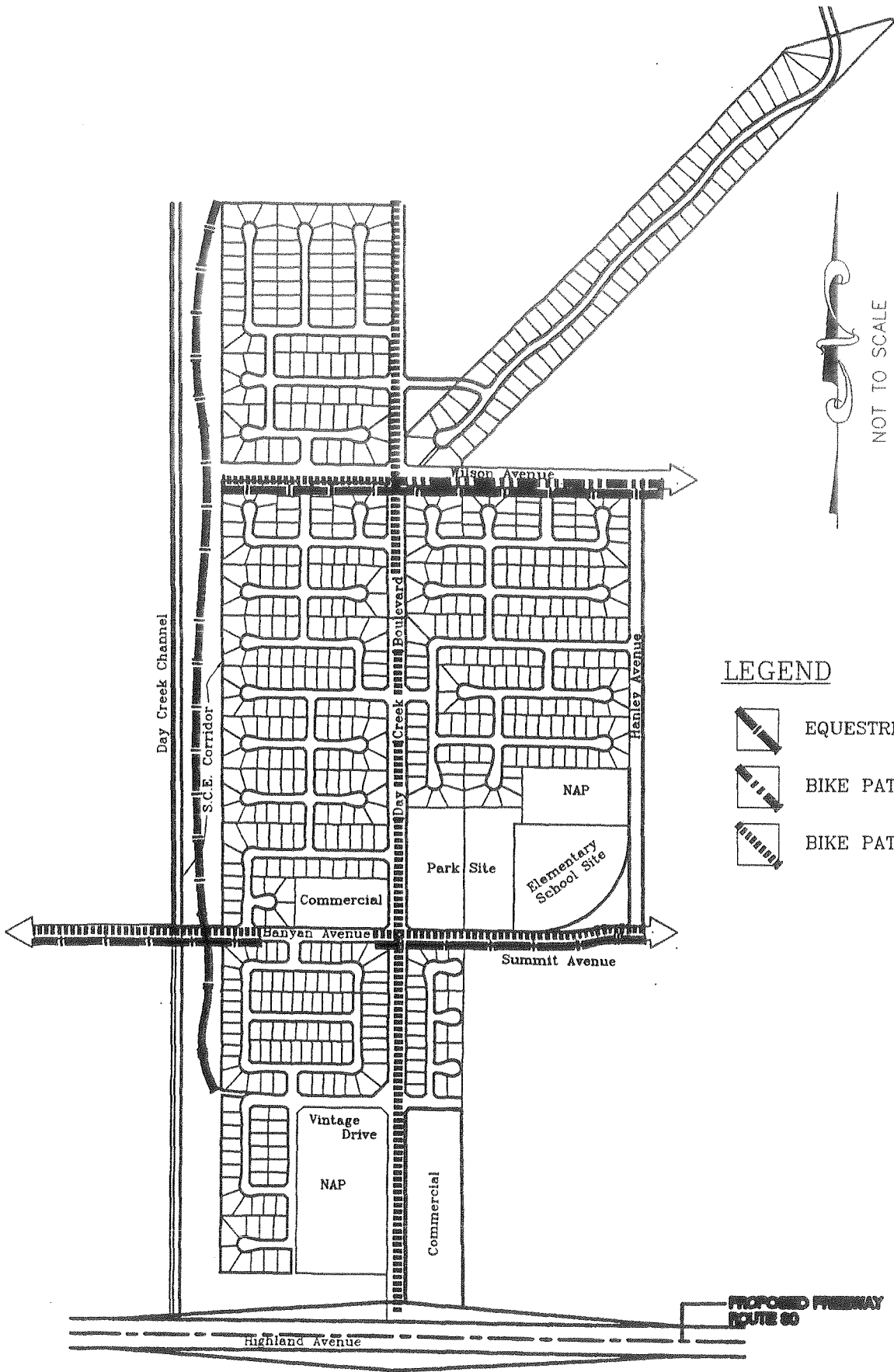
A traffic analysis of the revised University PD was prepared by Robert Kahn, John Kain and Associates (RKJK) in January, 1999. The results of their analysis indicated that a downsizing of the Day Creek Boulevard was justified based on the change in anticipated land uses located north of the University site. RKJK has recommended that Day Creek Boulevard should be constructed as a four lane roadway between SR-30 Freeway and Summit Avenue; as a two lane divided roadway between Summit Avenue and Wilson Avenue; and as a two lane undivided roadway north of Wilson Avenue. The overall vehicular circulation plan is shown in Exhibit 9. Selected roadway sections throughout the project site are presented in Exhibit 10, 10A and 10B.



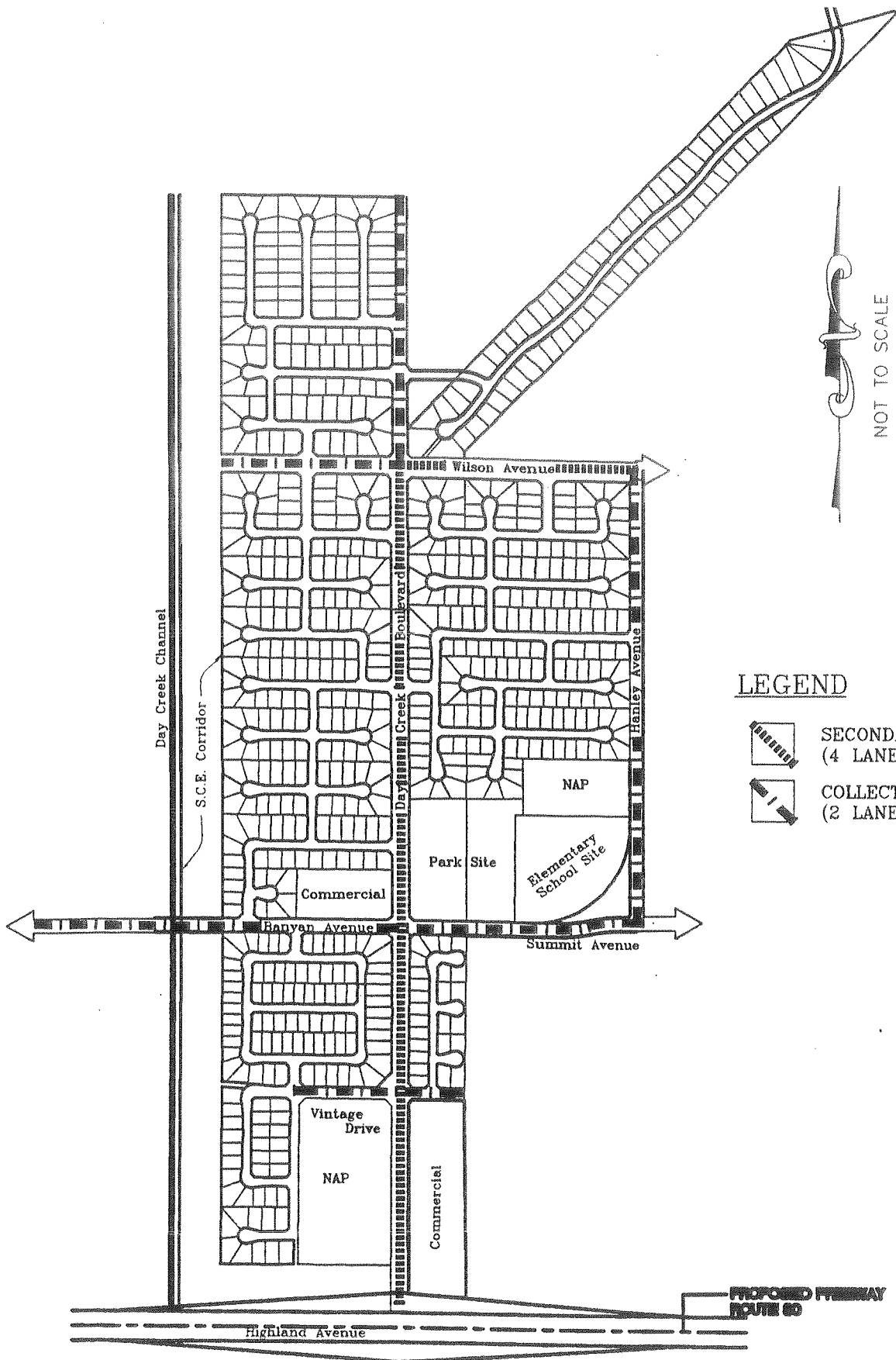

LEGEND

-  EQUESTRIAN TRAILS
-  BIKE PATHS (OFF STREET)
-  BIKE PATHS (ON STREET)



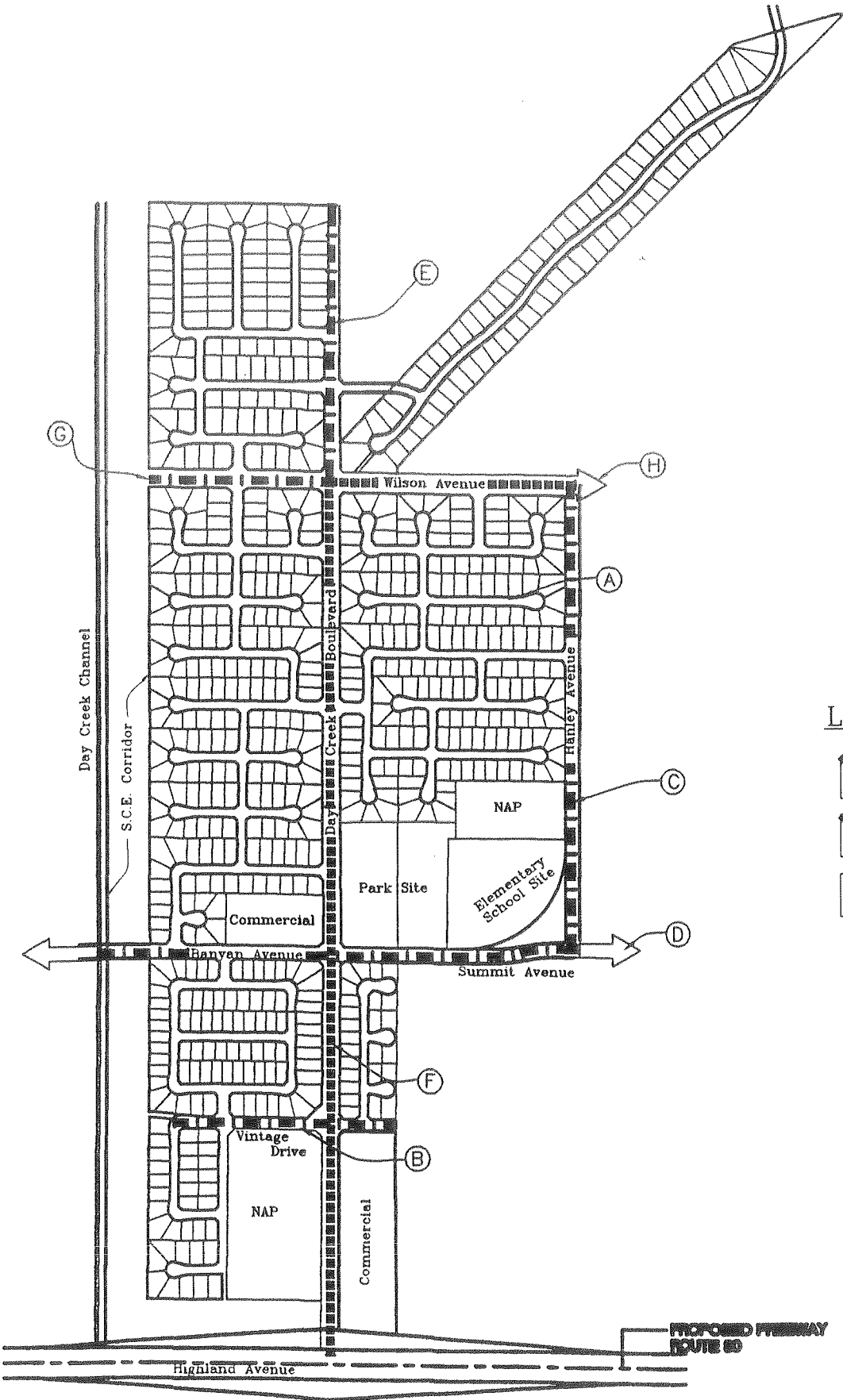

LEGEND

-  SECONDARY COLLECTOR
(4 LANE - UNDIVIDED)
-  COLLECTOR
(2 LANE - UNDIVIDED)



LEGEND

-  SECONDARY COLLECTOR
(4 LANE - UNDIVIDED)
-  COLLECTOR
(2 LANE - UNDIVIDED)
-  SECTION KEY

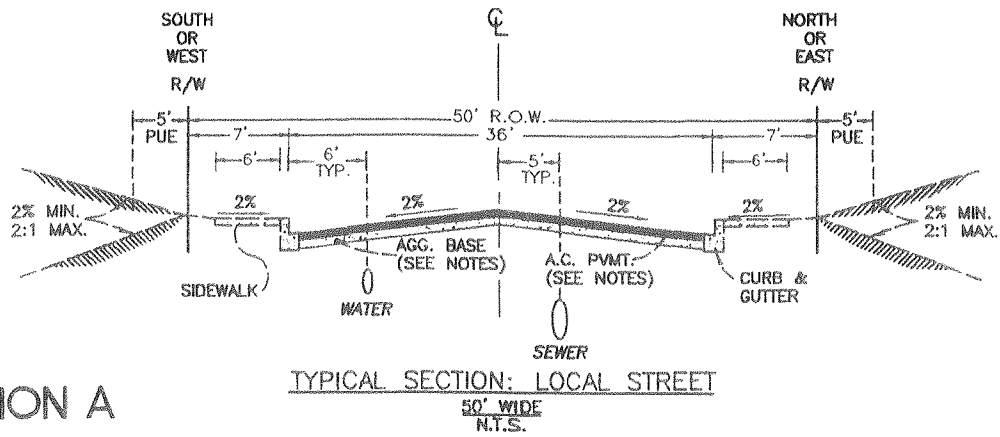

SECTION A

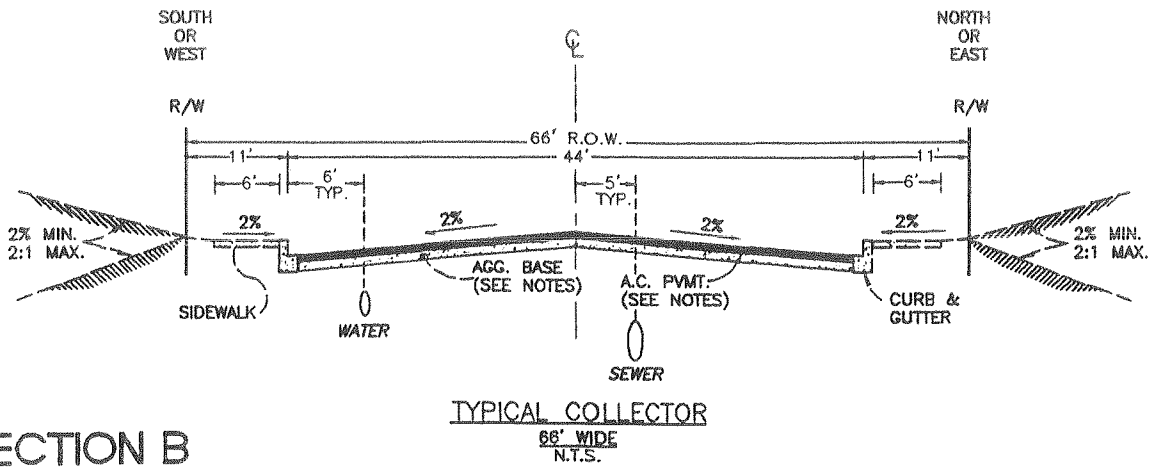

SECTION B

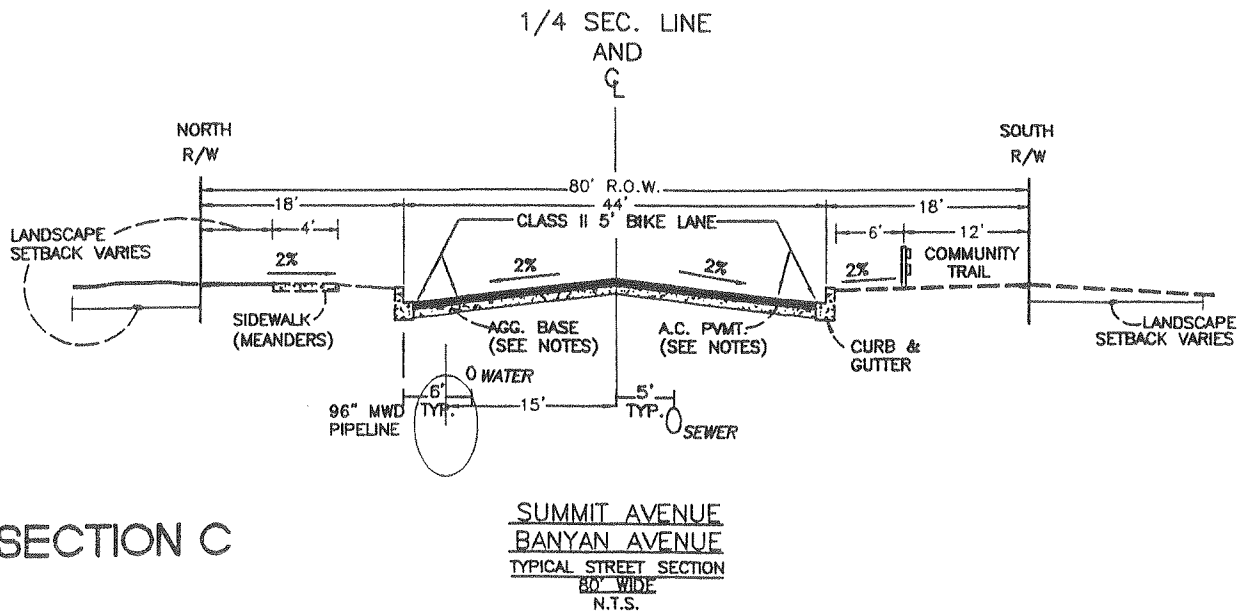

SECTION C

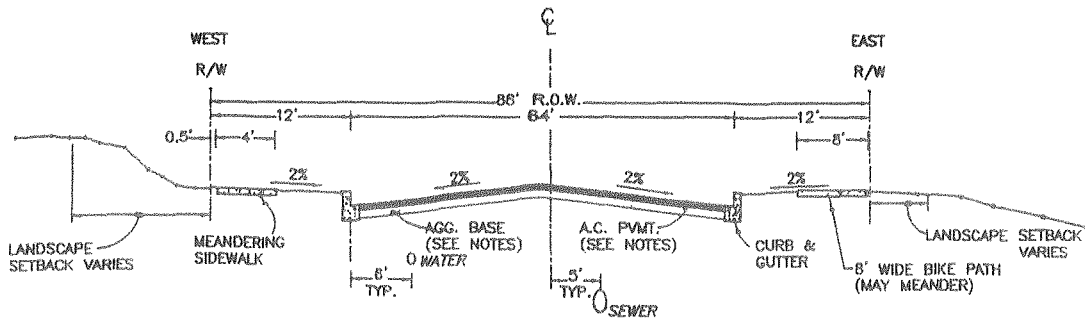

SECTION D

TYPICAL SECONDARY HIGHWAY
86' WIDE
N.T.S.

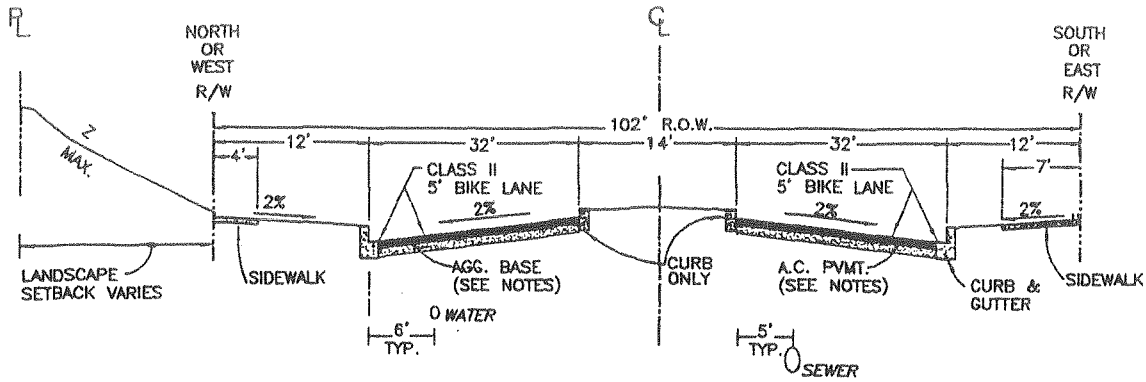

SECTION E

WILSON AVENUE
DAY CREEK BLVD.
HIGHLAND TO WILSON
N.T.S.

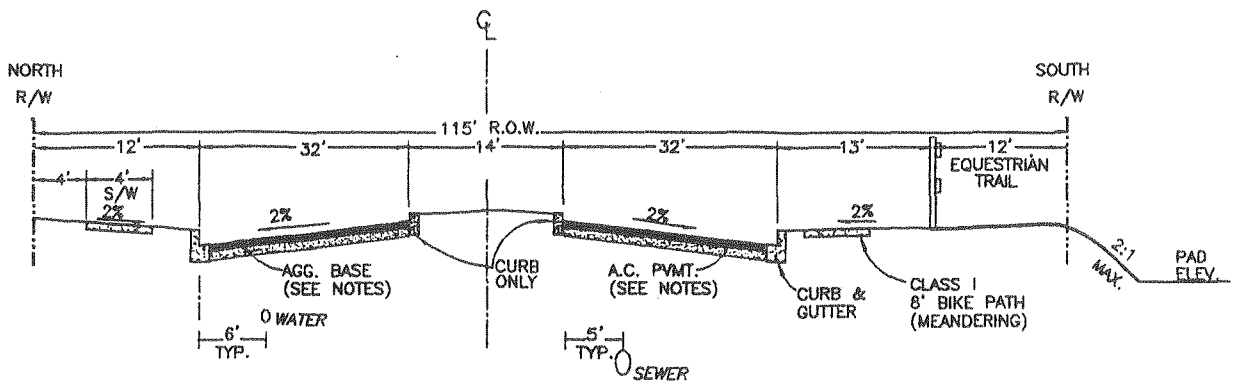

SECTION F

WILSON AVENUE
N.T.S.

IV. PUBLIC SERVICES AND FACILITIES

A. PUBLIC SERVICE AND FACILITY NEEDS

The land uses proposed in the West Valley Foothills Community Plan area are basically an extension of the development pattern occurring within adjacent communities. Densities proposed for the planning area were derived with these two considerations in mind: the ability to provide services to the planning area and the region's natural constraints. The absence of development in the planning area provides an excellent opportunity to design a comprehensive and environmentally sensitive plan which responds to local and regional issues.

B. COMMUNITY FACILITIES

1. Schools

The project site will be served by the Etiwanda School district (K-8) and Chaffey Joint Union High School. In accordance with the ratios suggested by the Etiwanda School District Superintendent, the site will generate approximately 388 K-8 and 124 high school students from the 618 new homes. Approximately 268 of these students would be elementary level (K-5) and 120 would be intermediate level (grades 6-8). The total students generated would be approximately 512.

To accommodate the need for school facilities, an elementary school site is proposed to be provided along Summit Avenue near Day Creek Boulevard. It is envisioned to be part of a larger community hub including a park, community and retail facilities. A future intermediate school is proposed nearby to the east of the development.

2. Police and Fire Service

Police protection for the project site is provided by the San Bernardino County Sheriffs' Department, Rancho Cucamonga Substation, located at 9th Street and Hellman Street in the City of Rancho Cucamonga.

Fire protection will be provided by the Rancho Cucamonga Fire Protection District. The nearest fire station is located to the southwest of the site, at 12158 Baseline, east of Miliken Avenue. Fire services for this site are covered by a Community Facilities District.

3. Parks and Recreation

Recreation opportunities available within the West Valley Foothills planning area currently include use of open and undeveloped land for hiking, equestrian and motorcycle use. Forest Service Trail IN34 provides public access into the National Forest and other trails that lead to Mt. Baldy, Cucamonga Peak, Lytle Creek, and Pacific Coast Trail, among others.

Two regional parks are within a reasonable distance to the project site. Cucamonga-Guasti Park encompasses 54 acres and is located approximately six miles southwest of the planning area. Glen Helen Park is a 500 acre park located approximately nine miles northeast of the planning area on Interstate 15. As an additional project amenity, this project will add 172 acres of environmentally attractive land to permanent open space.

The design of the University PD includes the provision of a centrally located recreational hub. Per County requirements for parks, the project is required to provide 3 acres of parkland per 1000 population, resulting in a requirement for 5.6 acres of parkland. (assumes 2.75 persons per household). This development proposes the dedication and improvement of a 10 acre park on the north-side of Summit Avenue between Day Creek Boulevard and Hanley Street.(Exhibit 7). The land for the park will be dedicated concurrent with the recordation of the first final tract map within the University PD and will be improved and operational concurrent with the issuance of the 300th building permit for the project. In addition to parkland, the University PD proposes an 8 acre school site immediately adjacent to the park. The synergy created by the co-location of these two facilities will provide both expansive recreational opportunities to the future residents of the area and also create a feeling of openness with the central portion of the project.

Exhibit 8 reflects the equestrian and bike trails designated for the area within the project. Trails along Wilson Avenue and Summit Avenue are located on the south side of the right-of-way. The trails planned in the SCE and MWD corridors are to be located per their respective standards. It is intended the trails will utilize the current SCE service roads within the corridors. Twelve (12) paseos will connect the project to the SCE corridor. The paseos will be landscaped access points that will provide a direct link from the residential areas to the SCE corridors. The precise locations of the paseos will be determined concurrent with the review of the respective tentative tract maps.

C. INFRASTRUCTURE

1. Water Supply

Domestic water service to the project will be supplied by the Cucamonga County Water District (CCWD). CCWD is a member agency of the Chino Basin Municipal Water District (CBMWD) which is a member agency of the Metropolitan Water District of Southern California (MWD).

CCWD derives its water from three (3) major sources: ground water, surface water, and imported water. Ground water is extracted by wells in the Chino and Cucamonga basins. Almost ninety percent (90%) of the water supply is from underground sources. Water quality is considered excellent.

Surface water is obtained from Day Canyon and East Etiwanda Canyon and is treated at the Royer-Nesbit Plant which is located near Day Creek. During the summer months when surface flows are low, the Royer-Nesbit plant also treats imported water from the Metropolitan Water District Foothill Feeder, which distributes water from the Colorado River Aqueduct and the California Water Project.

The CCWD water system is adequate to service the project site since the Water System Master Plan is based upon land use projections identified by the Rancho Cucamonga General Plan and the high-end projections of the West Foothills Valley Community Plan.

The project site is covered by two (2) water pressure zones as defined by CCWD water system master plan. These are zones 4 and 5C.

Pressure zone 4 extends from Highland Avenue to approximately Wilson Avenue. Water in pressure zone 4 will be supplied by existing 16" lines in Hanley Street and lower Summit Avenue.

Pressure zone 5C lies to the north of pressure zone 4 and extends to the northerly tip of the project. CCWD has completed construction of reservoir 5C, its booster station, and major transmission lines to service the 5C pressure zone.

The location of all proposed on-site water facilities are shown in Exhibit 11 and the location of all proposed off-site water facilities are shown in Exhibit 12.

2. Sanitary Sewer System

Sanitary sewer service will be provided by CCWD. The construction of this project will require the extension of a sewer trunk identified in CCWD master sewer plan. The sewer trunk is the Day Creek Trunk line.

The Day Creek sewer will be extended from an existing sewer near Baseline and future Day Creek Boulevard. The sewer will extend approximately 5,000' northward to the site and will follow the alignment of the future Day Creek Boulevard. This sewer is expected to service the western half of the site and the areas south of Wilson Avenue. These areas include areas A, B, C, D, E, F, and H.

The location of all proposed on-site sewer facilities are shown in Exhibit 11 and locations of all the off-site sewer facilities are shown in Exhibit 12.

CCWD has sized the off-site sewer facilities but they are currently in the process of updating their Sewer Master Plan. Therefore, specific sizes are presently unknown. This report shows the sizes as currently depicted in CCWD sewer master plan.

3. Solid Waste

Solid waste disposal will be handled by one of several solid waste handlers licensed to operate in this area of San Bernardino County. Handlers will contract with individual homeowners. Solid waste will be deposited in the Mid-Valley Landfill located in Rialto.



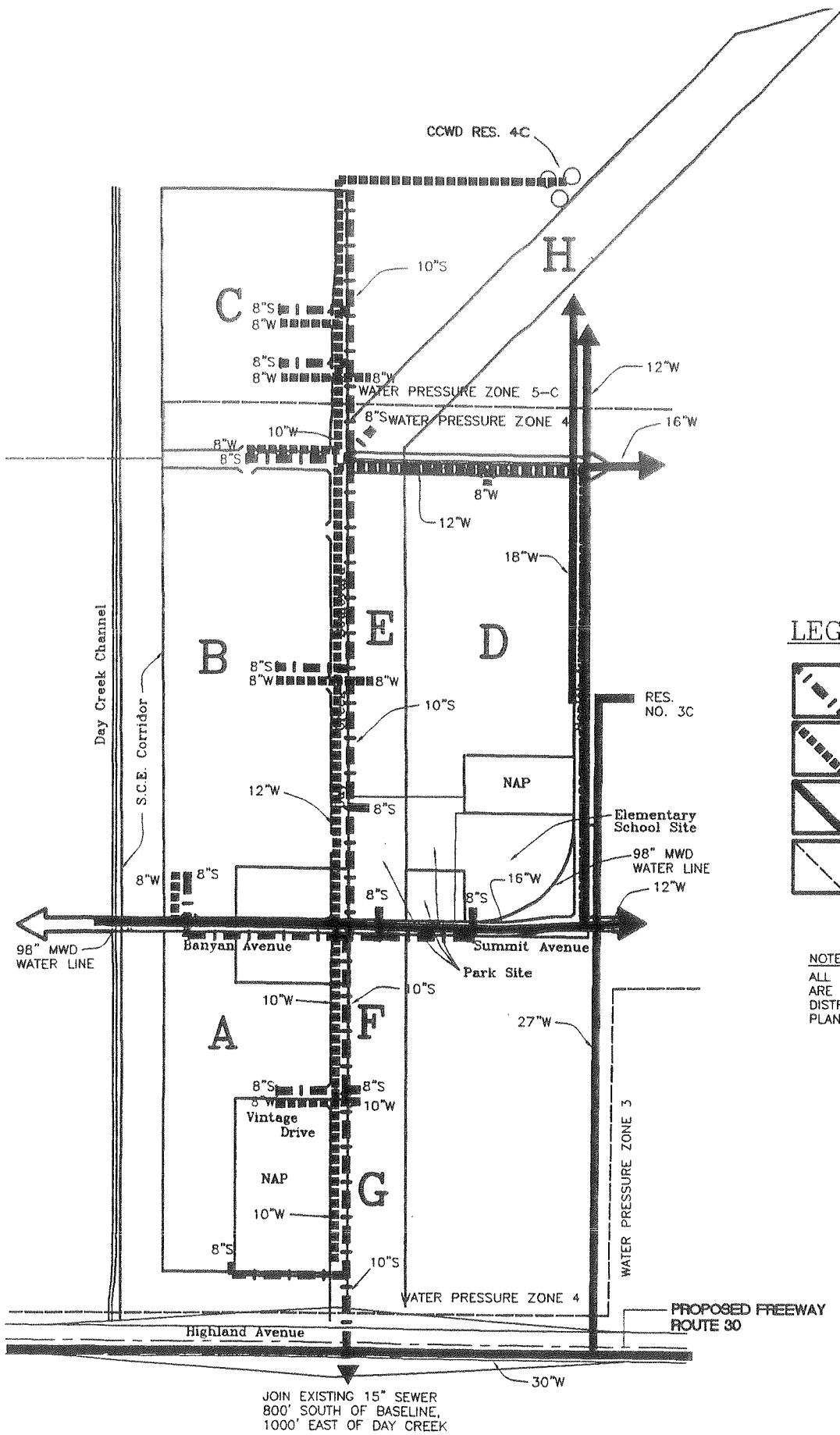

4. Storm Drain System

On-site storm water facilities will be provided on the project site as part of the development. These facilities will be constructed to meet rational method criteria of the County of San Bernardino. All streets will be designed so that storm water does not exceed the top of curb for a 25 year storm and the right-of-way line for a 100-year storm on any street, the excess will be picked up in a storm drain. It is proposed that all facilities will be designed to handle the ultimate drainage that would be tributary to the area. All on-site flows will collect and outlet into Day Creek or Etiwanda Master Plan Drainage systems.

NOT TO SCALE



LEGEND

-  PROPOSED SEWER
-  PROPOSED WATER
-  EXISTING WATER
-  WATER PRESSURE ZONE BOUNDARY

NOTE:
 ALL FACILITIES AND PIPE SIZES SHOWN
 ARE PER CUCAMONGA COUNTY WATER
 DISTRICTS SEWER AND WATER MASTER
 PLANS.

ALLARD ENGINEERING

EXHIBIT 11
ON-SITE WATER AND SEWER



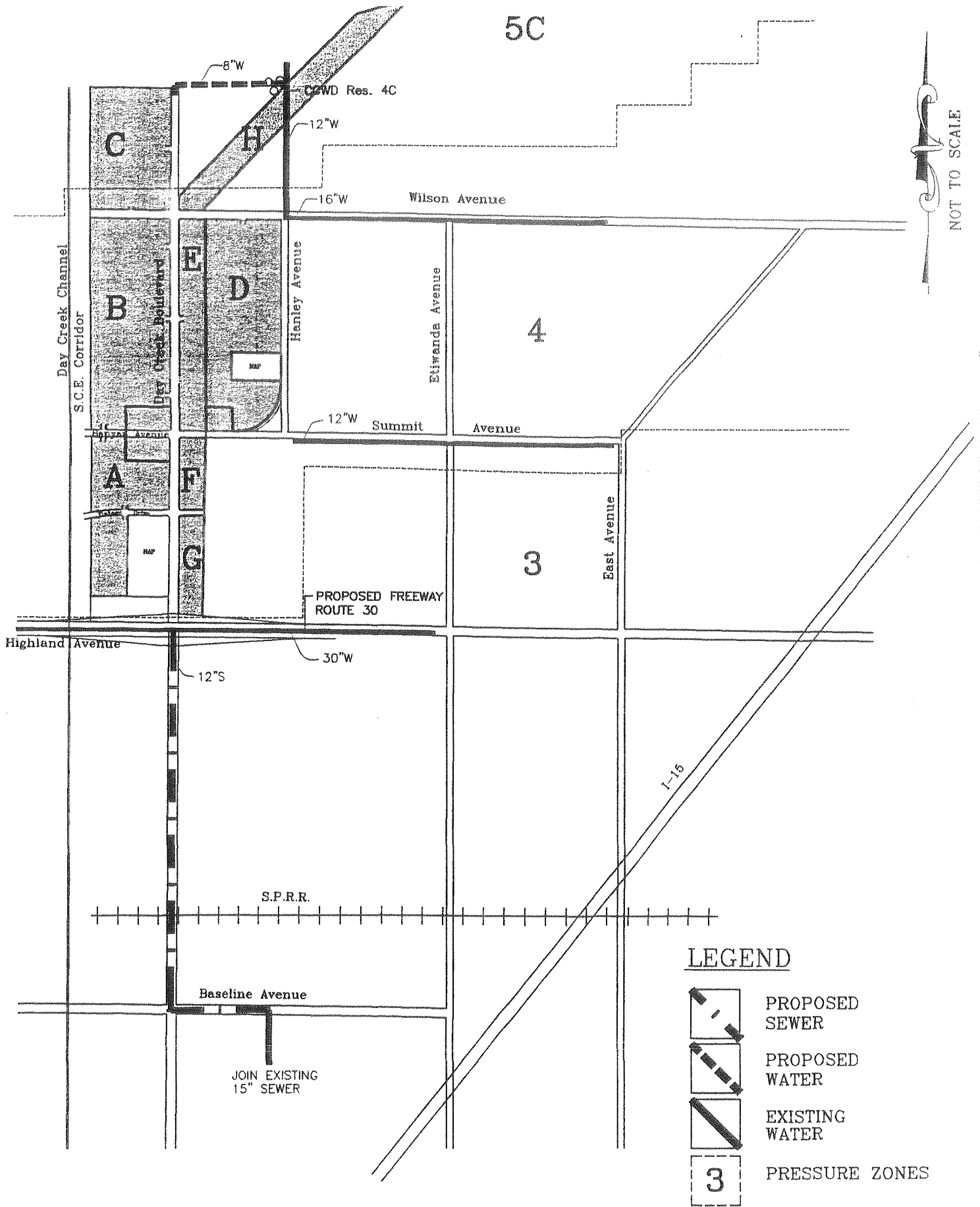

UNIVERSITY
PLANNED DEVELOPMENT

5C

NOT TO SCALE



LEGEND

-  PROPOSED SEWER
-  PROPOSED WATER
-  EXISTING WATER
-  PRESSURE ZONES

ALLARD ENGINEERING

Exhibit 13 indicates the basic conceptual design of the storm drain system.

Existing On-Site

The site falls basically from north to south at an average rate of plus or minus 6%. The existing site conditions are shown in Exhibit 14. All calculations are based on the San Bernardino County Flood Control Manual utilizing the rational method and a 100 year storm frequency. For purposes of the study, the site has been divided into three existing drainage areas as shown in Exhibit 15.

Water from the site sheet flows north to south toward Highland. At Highland, there is a corrugated pipe culvert to carry water under the street where it ultimately flows to Day Creek. North of Highland there exists a graded levee to protect the residential development south of Highland from flooding.

There are two off-site drainage areas identified to the north of the project. These flows will be intercepted prior to entering the site.



The location of all flows are shown in Exhibit 15.

The Federal Emergency Management Agency (FEMA)

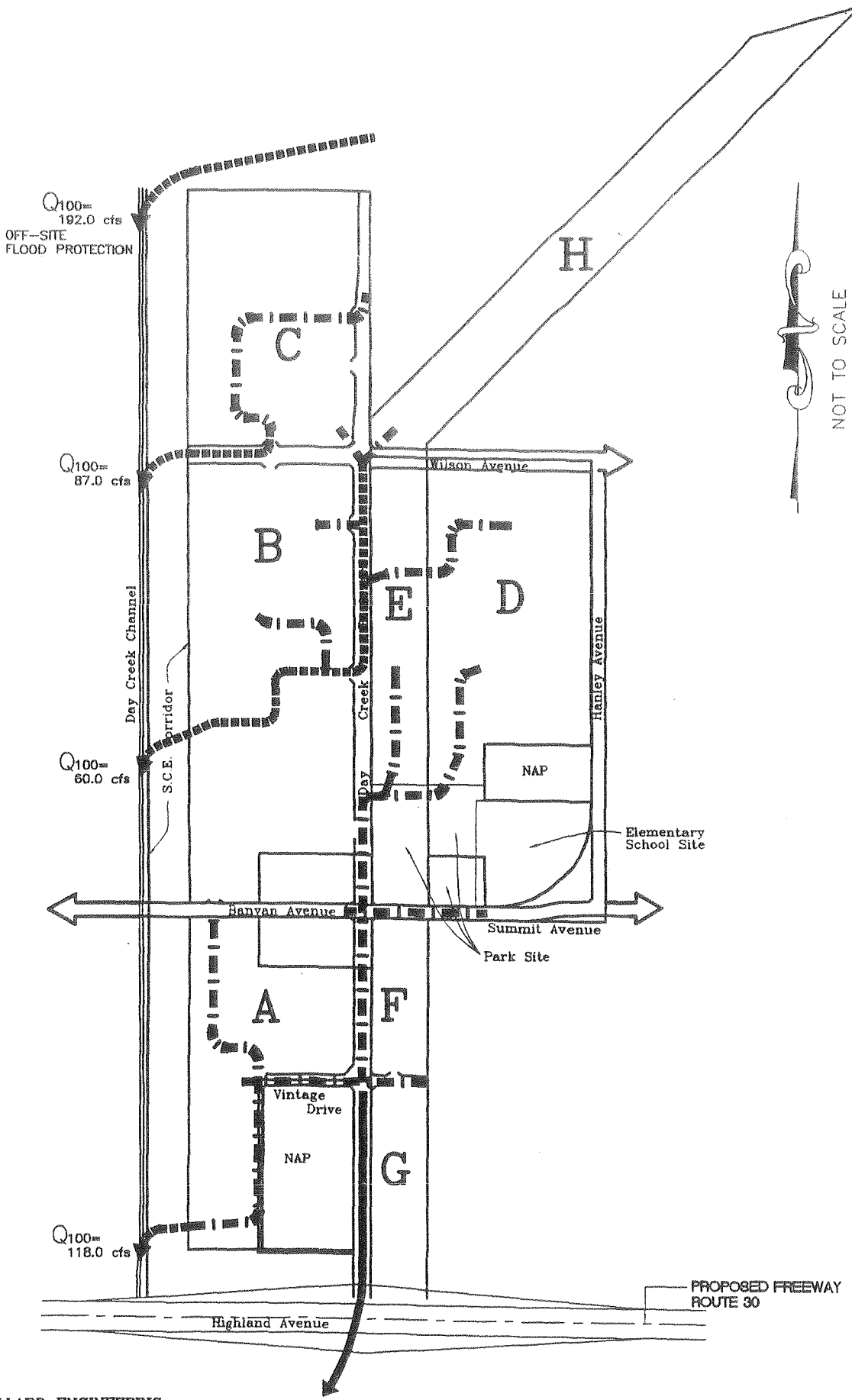
The Flood Insurance Rate Map (Panel 7900 of 9375) indicates that the project area is covered by two zones. The southwest portion of the site is in Zone A and subject to 1' deep sheet flow from the Day Creek system. The remainder of the site falls within Zone C and is explained as an area of minimal flooding. Current applications to FEMA address the flood potential for the project site from both Etiwanda and the Day Creek system.



LEGEND

-  ON-SITE CONNECTION
-  OFF-SITE CONNECTION
-  OPTIONAL

LLARD ENGINEERING

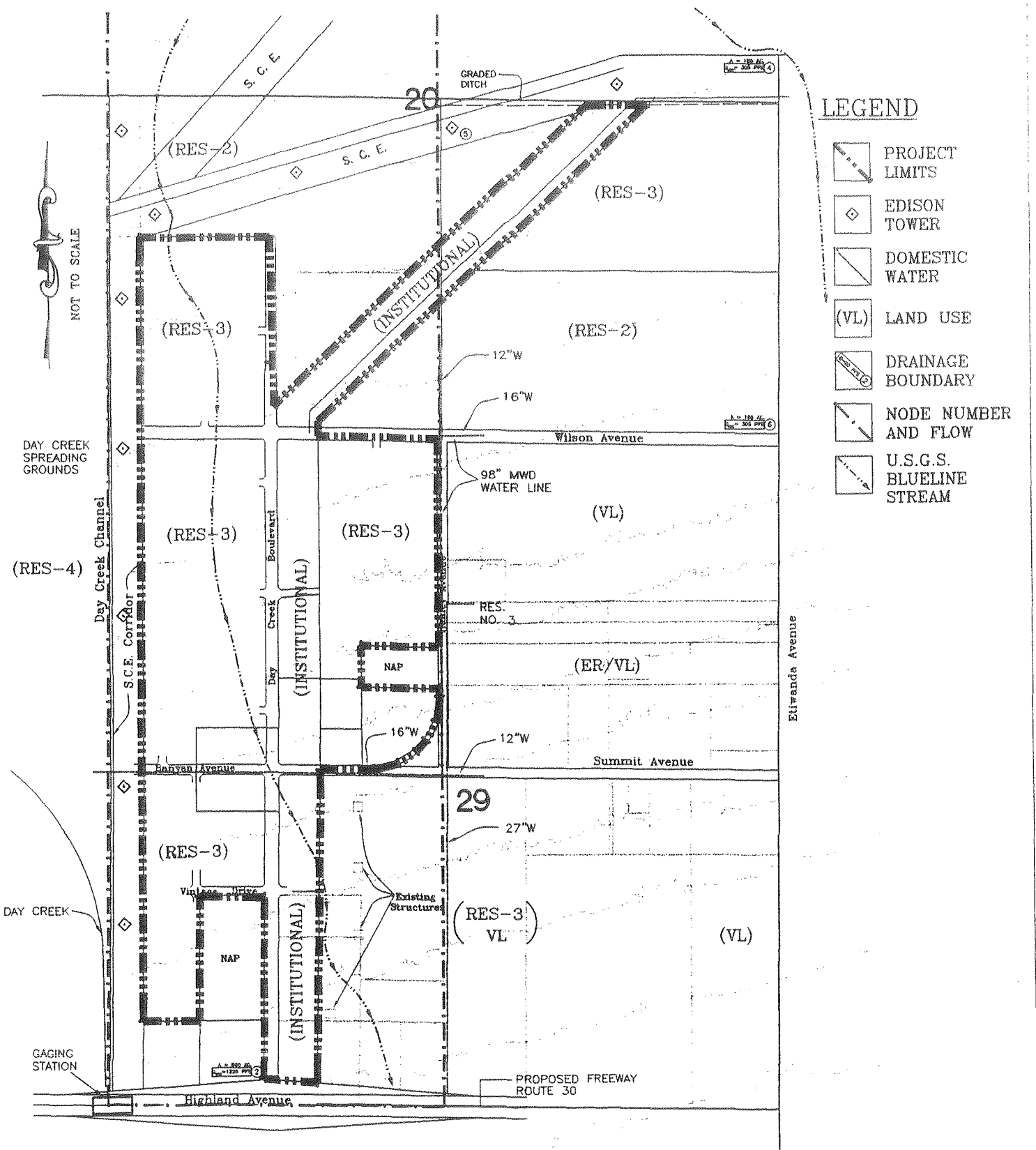

LEGEND

- PROJECT LIMITS
- EDISON TOWER
- DOMESTIC WATER
- LAND USE
- DRAINAGE BOUNDARY
- NODE NUMBER AND FLOW
- U.S.G.S. BLUELINE STREAM



ALLARD ENGINEERING

EXHIBIT 14
EXISTING SITE CONDITIONS

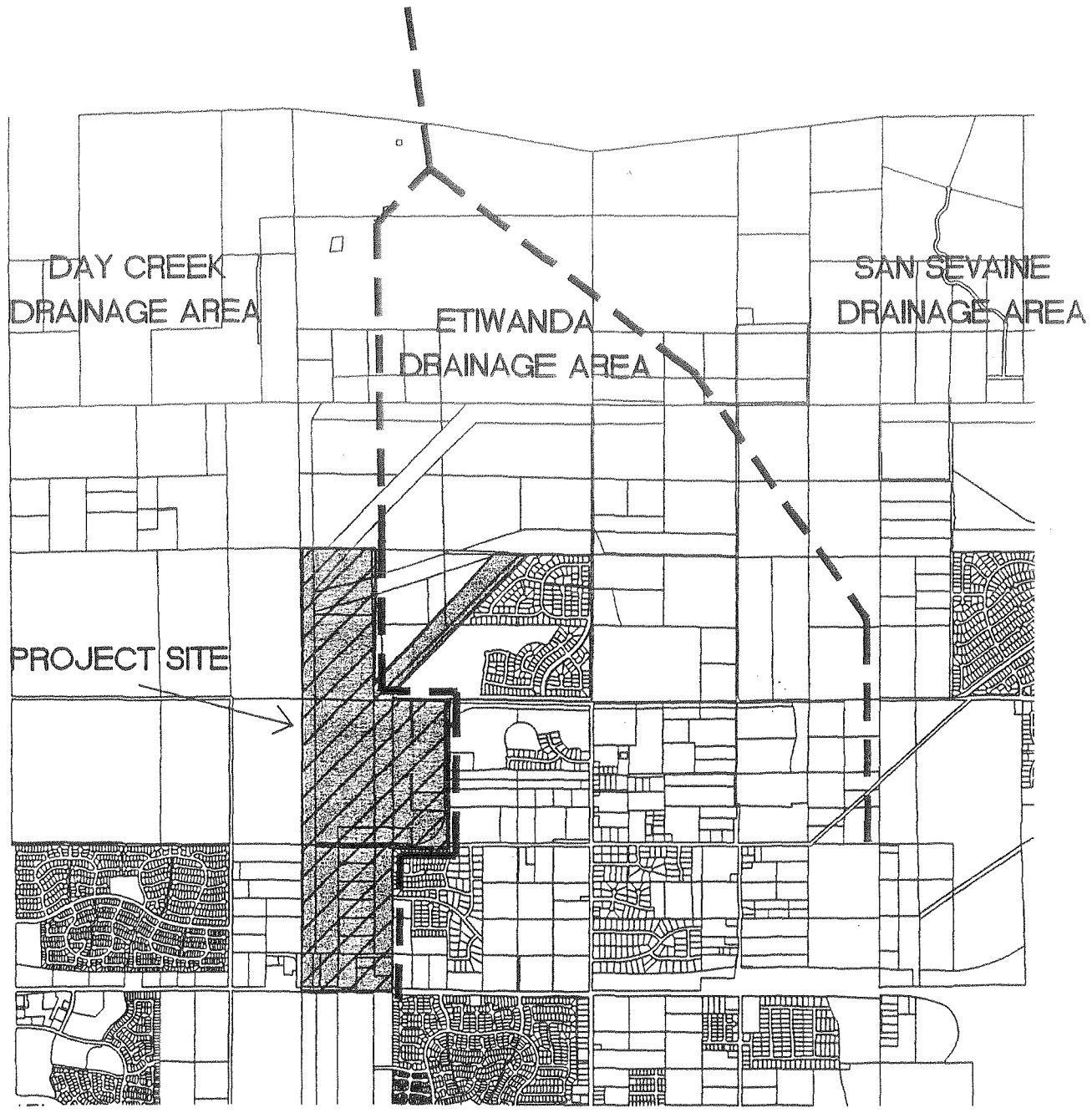
UNIVERSITY
PLANNED DEVELOPMENT



LEGEND

-  PROJECT SITE BOUNDARY
-  MASTER PLAN FACILITY
-  REGIONAL DRAINAGE AREA BOUNDARY

Proposed Onsite

For purposes of this study the site was divided into sub areas corresponding to the lot layout plan (Refer to Exhibit 6). On-site flows will be collected in closed conduit reinforced concrete pipe (RCP). The approximate location of these pipes can be seen on Exhibit 13. The system is designed to be consistent with the existing Master Plan of Drainage for Etiwanda Area and Day Creek. The storm water is transmitted to either Day Creek or to the Etiwanda Master Plan system in Etiwanda Avenue and Summit Avenue. Both of these facilities are discussed in greater detail below.

Regional Systems

The site drains into two regional drainage systems, Day and Etiwanda Creeks, which have been defined and studied by the City of Rancho Cucamonga in their Master Plan of Drainage and also by the firm of Bill Mann & Associates as part of the Day-Etiwanda-San Sevaine Master Plan, approved by the County and the City in 1983. Data from these studies will be utilized to insure this project conforms with earlier work. Adequate downstream capacity will be insured for increased run-off generated by the proposed development.

The Day Creek System is a debris dam and concrete lined channel running north to south along the western border of the project. For sites that lie within its drainage area, water will be collected and outlet into the creek through channel inlets. Existing inlets are located at Highland Avenue and 1.5 miles north of Highland Avenue. Two new channel inlets will be constructed to transmit flows to Day Creek.

The Etiwanda Area Master Plan of Drainage, prepared in February 1989, outlines the drainage facilities needed to control surface runoff and protect property within the Etiwanda area. The master plan facilities are partially shown on Exhibit 15. The predominately east/west system channels flow to Etiwanda Channel.

5. Utilities

Gas, telephone and electrical utilities are currently existing in the general area and shall be brought to and constructed within the project area by the developer. Maintenance of the utilities shall be performed by the appropriate utility company and the costs will be borne by the individual homeowners through monthly service charges.

5a. Electricity

Electrical service in the project area can be provided by Southern California Edison. Individual users with the project site will have the opportunity to have electricity provided by a wide array of suppliers under the recent state deregulation on provisions. Existing facilities in Highland Avenue shall be up-sized as required to provide adequate service to the project site. On-site connections shall be made by the underground conduit.

5b. Natural Gas

The Southern California Gas Company will provide natural gas to the project area. The gas company shall design the service systems required to accommodate the demands of the expected population.

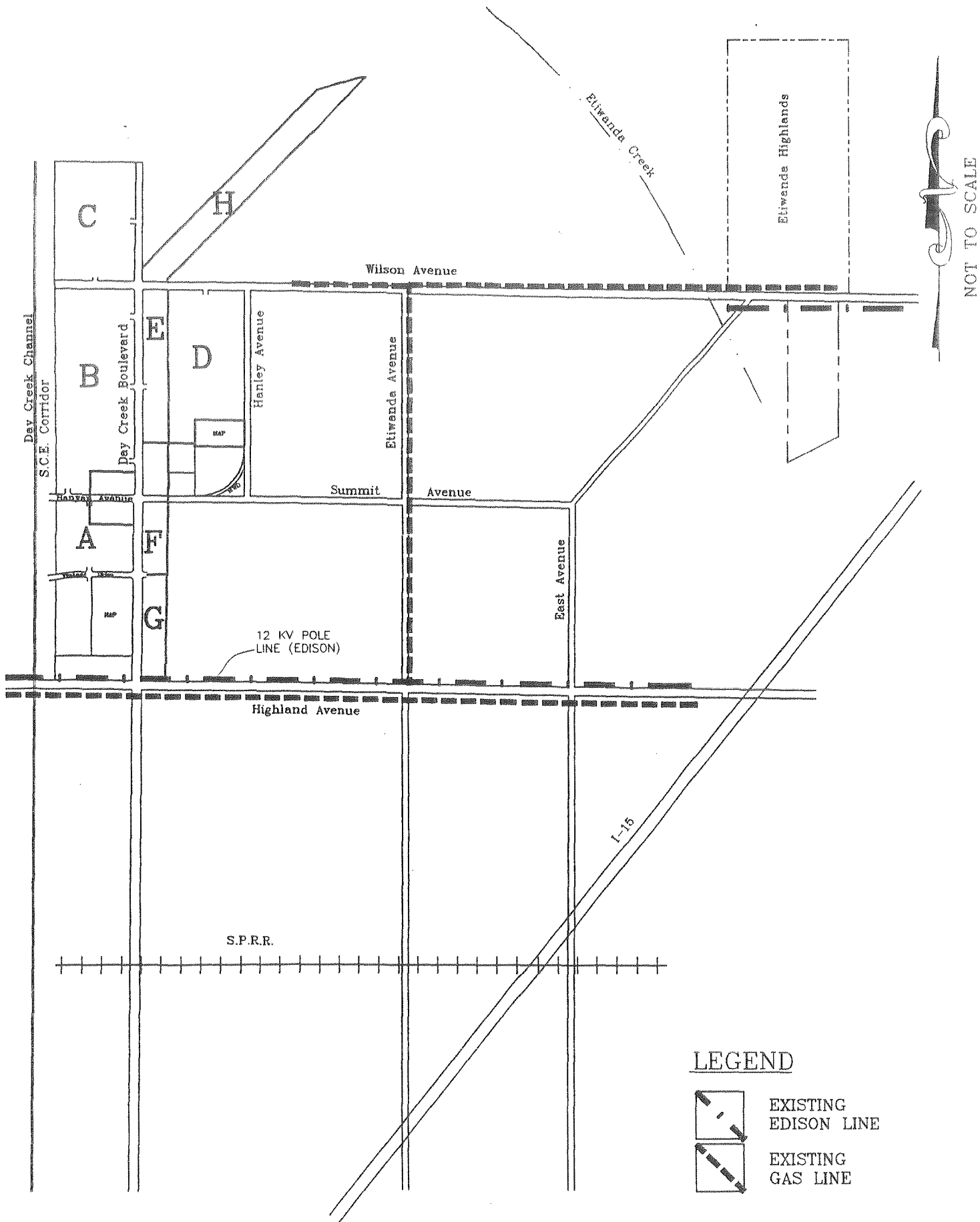

5c. Telephone

General Telephone Company will provide telephone service to the project site. Required plans for on-site service shall be done by General Telephone Company at the time of development. All the existing utilities are shown in Exhibit 16.



NOT TO SCALE

LEGEND

-  EXISTING EDISON LINE
-  EXISTING GAS LINE

V. COMMUNITY DESIGN

A. LANDSCAPE CONCEPT

The intent of the landscape plan will be to create a strong community image through the use of simple tree masses and street tree planting, as well as to reinforce and extend the existing landscape character of the area. Special attention will be given to the use of drought tolerant species of trees, shrubs, vines and low growing groundcover, thus emphasizing a more rural and naturalized appearance to the area. Theme walls and entry areas will have flowering vines which will serve to reinforce the landscape concept. Lawn areas will comprise less than 30% of parkway areas.

The University PD will be characterized by avenues lined with stately camphor trees, palm lined medians with backdrops of pines and flowering trees. In addition, the neighborhoods will be characterized by enhanced entries.

Landscape Palette/Design

The plant palette was developed with the community theme in mind along with plant suitability for the area. Selections were made with respect to drought tolerance, low maintenance and native species along with their relationship to climate and soil conditions. Suitability of plant material for high fire hazard areas was also an important parameter in determining the plant palette. The complete Plant Palette is presented in Appendix B of this document.

Landscape Standards

All residential, commercial and public land uses shall be landscaped using the plant palette. These standards shall apply to all landscaped areas with the exception of private residential yards, in which case they serve as guidelines.

- a. All landscaping must be done with plants from the palette of trees, shrubs, vines and ground covers listed within the Plant Palette located in Appendix B of this document. Plants not included in the palette, but recommended by a registered landscape architect, may be used if approved by the Land Use Services Department for areas other than those where a planting design is specified on the Final Development Plans.

- b. Horticultural soil tests are important for proper landscape development. Such reports are recommended for the public landscape areas and shall be obtained prior to landscape installation from a qualified agricultural laboratory. The test summaries should include analysis of soil fertility and agricultural suitability, and provide recommendations for pre-plant amendments, backfill mix and post plant maintenance fertilization.
- c. Automatic irrigation is required as a part of landscape development of the public common area. Irrigation systems shall be designed with coverage necessary to accommodate seasonal wind patterns. All developments shall include a Calsense control system as part of the automatic irrigation system or similar system to conserve water. The automated system shall be designed and constructed to accommodate adaptation to a master computerized control system. Plants using similar water requirements shall be grouped together and metered to assure that the watering requirements are met. It shall be the responsibility of the developer providing the public landscape improvements to coordinate the design and location of the irrigation systems with the County to insure compatibility with existing systems. Controllers shall be capable of repeating individuals systems during the course of the day to expedite plant establishment. Moisture sensors or similar devices shall be used as part of this system. Brown line pipe may be used on slopes within private lots and located on the soil surface. All other pipe shall be buried below ground. Additional equipment such as controllers and backflow preventers should be located to minimize their impact on the streetscape.
- d. Prior to issuance of any building permits, landscape plans shall be approved by the Land Use Services Department for the project. Landscape plans must address all of the appropriate grading and landscaping standards and guidelines contained in the Planned Development.
- e. Specific planting, staking, watering, and replacement requirements shall be established by the responsible service district for any landscaping in public areas including, but not limited to street rights-of-way and parks.
- f. Slope areas shall have the following requirements:
 - 1) Slope areas are permitted within the public landscape areas at gradients not to exceed 2:1 or prevailing County standards. The intent within the slope areas is to create an undulating character and should include primarily 3:1 slopes with a maximum 2:1 condition.

- 2) Graded slopes shall be re-vegetated as soon as feasible with groundcover or a combination of groundcover, shrubs and trees from the approved lists. Hydroseed may substitute for groundcover plantings. Groundcovers shall possess moderate or high erosion control qualities and all plantings shall conform to the applicable community landscape guidelines.
 - 3) All 2:1 or greater slopes adjacent to arterial and collector roads must be planted with trees and woody shrubs to attain 100% coverage at maturity.
 - 4) Interior private yard slopes required to be landscaped shall include drought-tolerant, low maintenance plant material. All slopes shall receive groundcover, shrubs and one (1) tree for every 150 square feet of area. A ratio of 50% five (5) gallon and 50% fifteen (15) gallon shall be provided for trees.
 - 5) Transition areas - Areas adjacent to residential development or manufactured slopes adjacent to open space lots which are natural or manufactured slopes at 2:1 or steeper will be planted with trees to 40% coverage at maturity and automatically irrigated.
 - 6) Slopes greater than 2:1 ratio shall be substantiated by a geology report.
- g. Where required, planting within naturalized open space and fuel modification zones must be with fire-resistant low fuel-load plant material. The open space will be planted with drought-tolerant trees required by the Land Use Services Department.
 - h. The landscape adjacent to major streets contributes significantly to the character of the area. The roadway, parkways, edges and medians should be fully landscaped with plant material as indicated on the Final Development Plans.
 - i. Street trees should be long-lived, deep rooted, and require little maintenance (structurally strong, insect and disease resistant, and require little pruning). Tree selection shall be from the approved Plant Palette.
 - j. Street trees shall be planted not less than:
 - 1) Twenty-five (25') feet back of beginning of curb returns at intersections;
 - 2) Ten (10') feet from lamp standards;
 - 3) Ten (10') feet from fire hydrants;

- 4) Five (5') feet from meters;
 - 5) Seven (7') feet from rear of sidewalk for large trees unless installed with root barriers or protective panels;
 - 6) Four (4') feet from sidewalk or curb for small trees unless installed with root barriers or protective panels.
- k. Street trees shall be a minimum container size of fifteen (15) gallon, with a minimum ratio of one (1) 24-inch box to every three (3) 15-gallon trees planted in parks. All street tree selections must generally conform to the standards of the San Bernardino County Transportation Department.
- l. Street trees in residential lot areas shall be planted with an average of one (1) tree per thirty (30') feet of street frontage.
- m. In commercial areas, street trees shall be planted at the equivalent of one (1) tree per thirty (30') feet of frontage.
- n. Parking lot trees in commercial and park sites shall have a mature height and spread of at least thirty (30') feet and spaced an average of one (1) tree every sixth space. They should also be long-lived, clean, require little maintenance (structurally strong, insect and disease resistant, and require little pruning). Trees shall be a minimum size of fifteen (15) gallon. Tree selection shall be from the approved tree list.
- o. Roadway landscape includes the land area lying between the paved road and adjacent private development. It also includes median planting where appropriate.

Under plantings within roadways shall consist of shrubs, groundcover or grasses. They shall conform to the character of the neighborhood in which they are located, and be selected from the approved landscape lists. Medians shall have a minimum of 20% to a maximum of 40% enhanced hardscape.

- p. When trails occur within natural open space including utility corridors, no landscape treatment is required. When trails occur within road rights-of way, the adjacent landscape treatment shall be as required for the roadway. When trails occur within publicly maintained paseos, the adjacent landscape treatment shall include tree masses and an under planting of shrubs, groundcover, or grasses. The tree sizes shall be mixed five (5) gallon, fifteen (15) gallon, and 24-inch box. Larger sizes are permitted.

B. ARCHITECTURE CONCEPT

1. Residential Uses

The choice of an architectural style for the University PD is intended to reinforce the "sense of place" established by the community wide design elements. This "sense of place" can be best accomplished by choosing an architectural tradition within which all structures will be designed. The architectural theme which best fulfills the above requirements is the traditional Early California style of architecture. Within the Early California tradition there is a variety of architectural styles. Within the University site, defined by river rock entry elements, the selected primary architectural styles include: Victorian, Country, Bungalow and Ranch. Graphic representation of the four architectural styles are shown in Exhibit 18, 19, 20 and 21. The architectural guidelines for these themes are presented in Table 6. It is the intent that this architectural tradition will create a sense of consistency throughout the community. This consistency is not meant to be constrictive, but rather to offer diversity within stated parameters.

2. Commercial Uses

The architectural design concepts for the commercial uses are identified below and shown in Exhibits 22 and 23). Design goals, principles, and building materials are described. A specific "style" i.e.; Victorian, Country, etc., is not identified at this time in order to allow the future design architect to work with the Land Use Services Department Staff on selecting one of the architectural styles deemed most appropriate.

a. Goals

- 1) Commercial buildings and developments which reflect creativity and innovation while remaining harmonious with the overall community.
- 2) Visually pleasing commercial projects which coordinate well with surrounding land uses.
- 3) Commercial uses which are functionally efficient.
- 4) Commercial uses which encourage user interaction.

*Similar to
Etiwanda North*

TABLE 6

ARCHITECTURAL GUIDELINES

	VICTORIAN	COUNTRY	BUNGALOW	RANCH
MINIMUM ROOF PITCH	7:12	6:12	4:12	4:12 breaking to 3:12
ROOF MATERIAL AND COLOR	All colors permitted, comp shingle permitted Varied shingle patterns encouraged	Flat concrete tile Light brown to black	Flat concrete tile Light to dark brown	Flat concrete tile Reddish brown to tobacco
OVERHANGS	12"	12" and 24"	36" and 24"	30"
PARALLEL VS. OPPOSING GABLES	75% parallel with 25% opposing gables	75% parallel with 25% opposing gables	75% parallel with 25% opposing gables	90% parallel with 10% opposing gables
SIDING	Narrow lap siding on all four sides	Siding on all 4 sides with areas of masonry or stucco Horizontal or vertical siding	Wide horizontal siding on all four sides	Wide horizontal siding. Can be used with stucco.
STUCCO FINISH AND COLOR	None	None	Stucco, if seen, is a sand finish and matches siding color	Smooth finish in light earthtone colors and white
CHIMNEYS	Brick/wood siding	Brick or stone	Wood siding/brick or stone veneer	Stucco chimney with stucco covered cap, brick or stone
PORCHES BALCONIES	Extensive use of front porch	Some front porches	Some front porches No balconies	Porches can be used at both front and rear, no steps. No balconies
WINDOW TREATMENTS	Accent shutters, bay windows, panes	Accent shutters, panes, wood trim surrounds	Wood trim surrounds, simple windows	Accent shutters on some windows, wood trim surrounds
DOORS	Entry doors have glass insets, wood trim surrounds	Simple entry doors with wood trim surrounds, sidelights	Simple doors with wood trim and sidelights	Simple entry doors with wood trim surrounds
ENTRY	Covered entry	Covered entry, normally raised 1 or 2 steps	Covered entry, sometimes raised	Covered entry with open trellis above
COLOR PALETTE	Siding in pastel colors, white trim	Siding in pastel and earthtone colors, trim in white	Light earthtone color with contrasting color on trim	Earthtone colors
VERTICAL VS. HORIZONTAL	70% horizontal and 30% vertical	75% horizontal and 25% vertical	90% horizontal and 10% vertical	95% horizontal and 5% vertical

Note: Porches need not be greater than 4'-5'-0" deep. The intent is to create the 'appearance' rather than an exact replica.

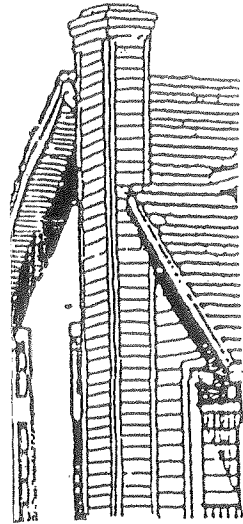
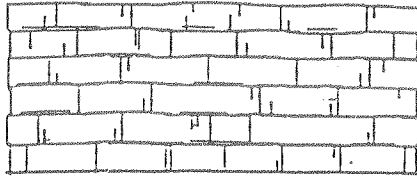
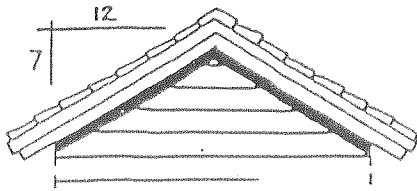

ROOF PITCH & MATERIAL

15

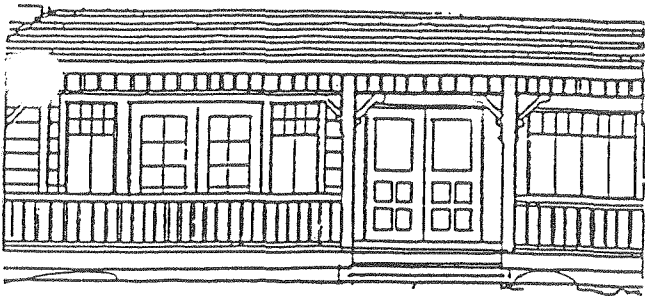

HALF-TIMBERED

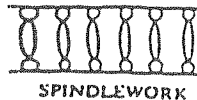

SPINDLEWORK

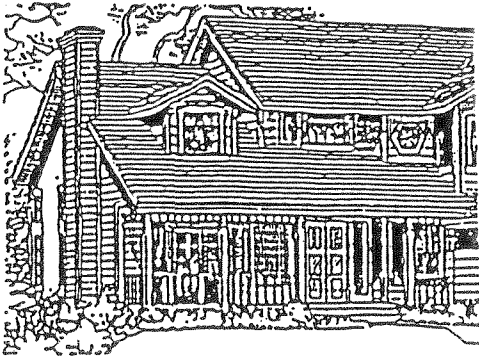

PORCHES & BALCONIES

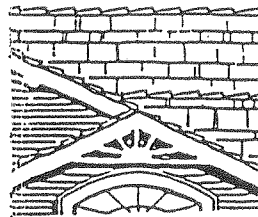

TAILS

EXHIBIT 18
 UNIQUE DETAILS
 ARCHITECTURAL THEME:
 VICTORIAN

UNIVERSITY
 PLANNED DEVELOPMENT

FOR:
 U.C.P. INCORPORATED

RANCH

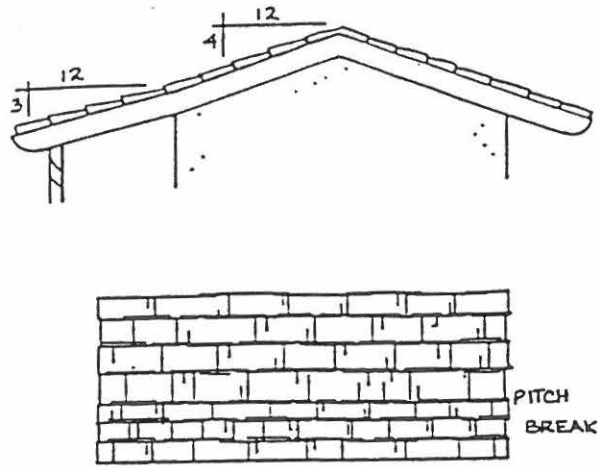

ROOF PITCH & MATERIAL

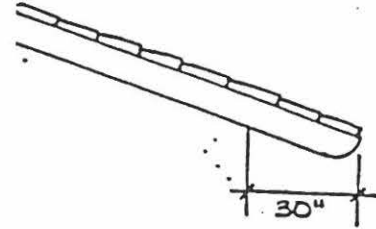

OVERHANGS

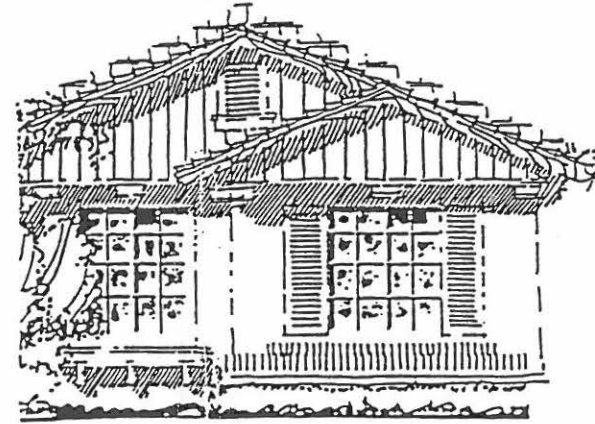

SIDING

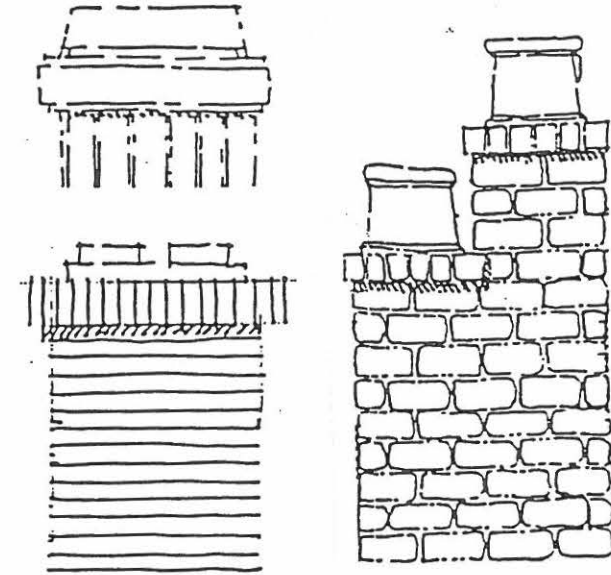

CHIMNEYS

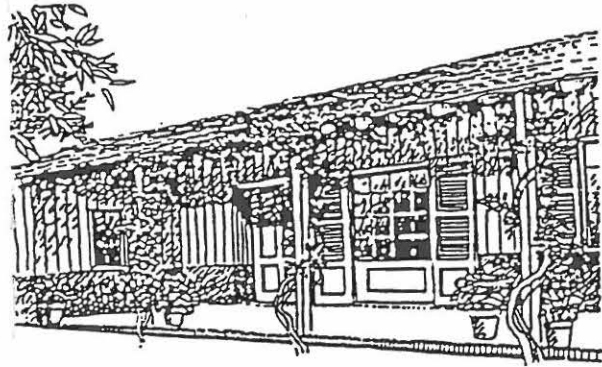

PORCHES & BALCONIES



DOORS & ENTRY

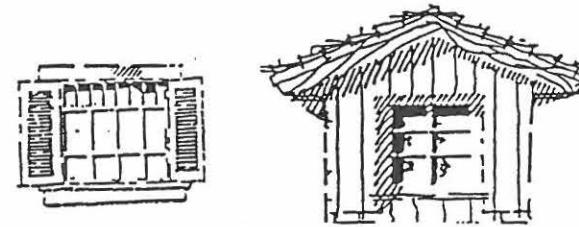

WINDOW TREATMENT

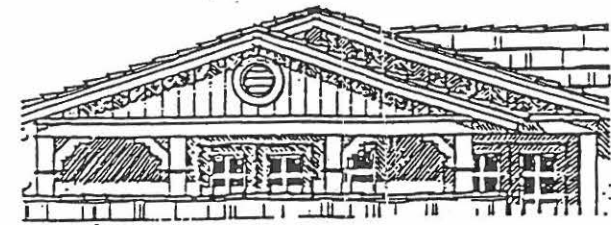

UNIQUE DETAILS

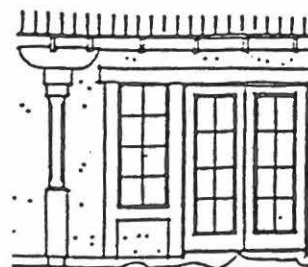
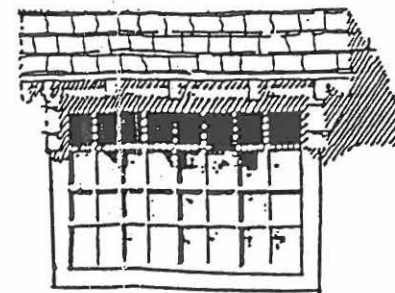
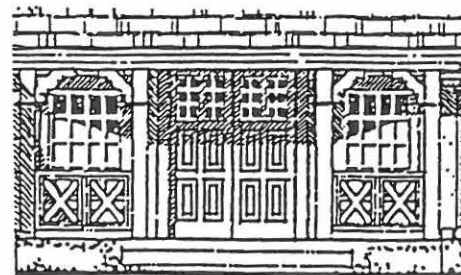
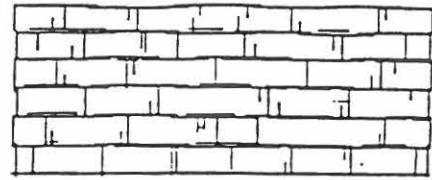
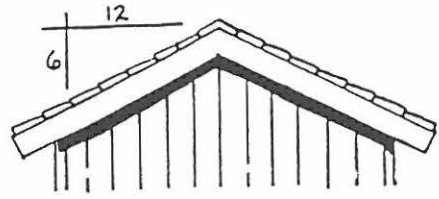

EXHIBIT 21
UNIQUE DETAILS
ARCHITECTURAL THEME:
RANCH

UNIVERSITY
PLANNED DEVELOPEME

COUNTRY



ROOF PITCH & MATERIAL

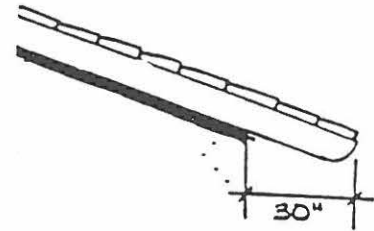

OVERHANGS



SIDING

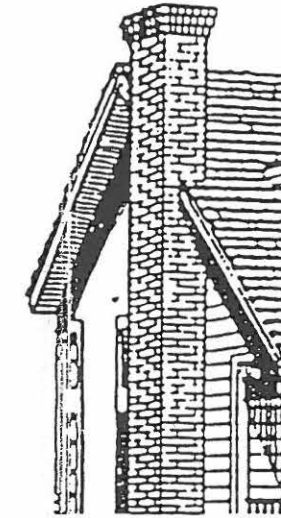
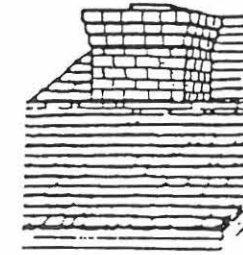

CHIMNEYS

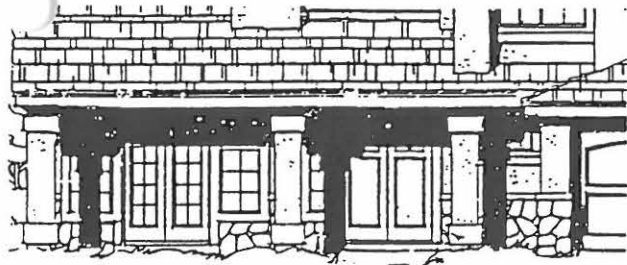

PORCHES & BALCONIES



DOORS & ENTRY

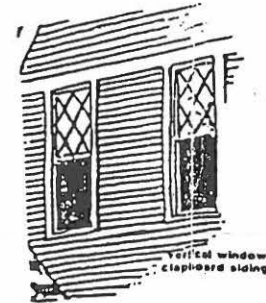

WINDOW TREATMENT



UNIQUE DETAILS

EXHIBIT 19
UNIQUE DETAILS
ARCHITECTURAL THEME:
COUNTRY

UNIVERSITY
PLANNED DEVELOPMENT

FOR:
U.C.P. INCORPORATED

BUNGALOW

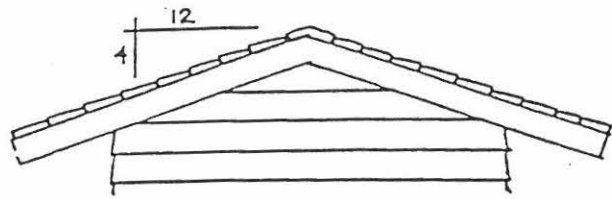

ROOF PITCH & MATERIAL

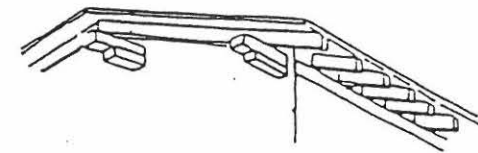
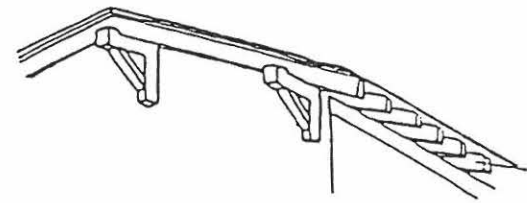

OVERHANGS

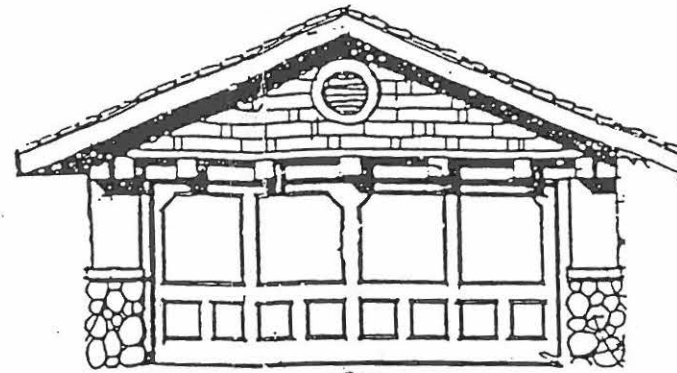

SIDING

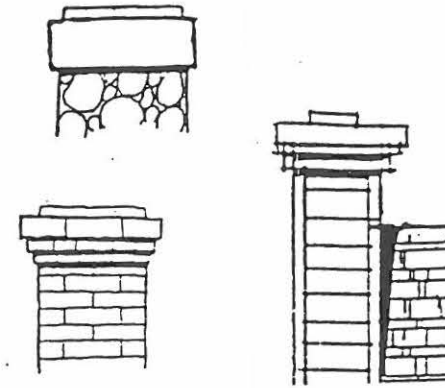

CHIMNEYS



PORCHES & BALCONIES



DOORS & ENTRY



WINDOW TREATMENT

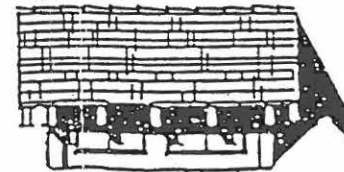

UNIQUE DETAILS

EXHIBIT 20
UNIQUE DETAILS
ARCHITECTURAL THEME:
BUNGALOW

UNIVERSITY
PLANNED DEVELOPMEN

FOR:
U.C.P. INCORPORATED

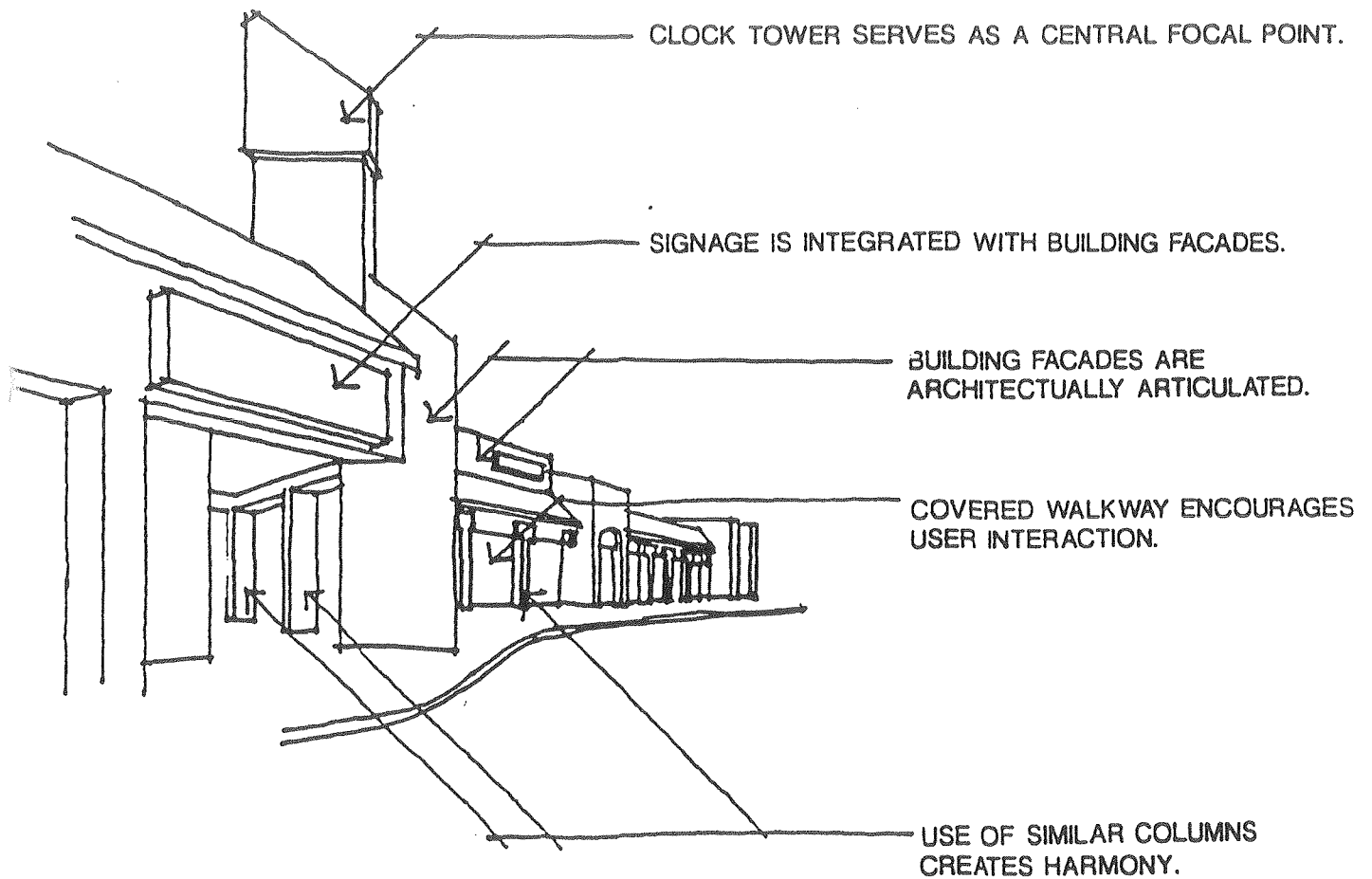

EXHIBIT 22
COMMERCIAL
ARCHITECTURAL
GUIDELINES

UNIVERSITY
PLANNED DEVELOPMENT

FOR: U.C.P. INCORPORATED

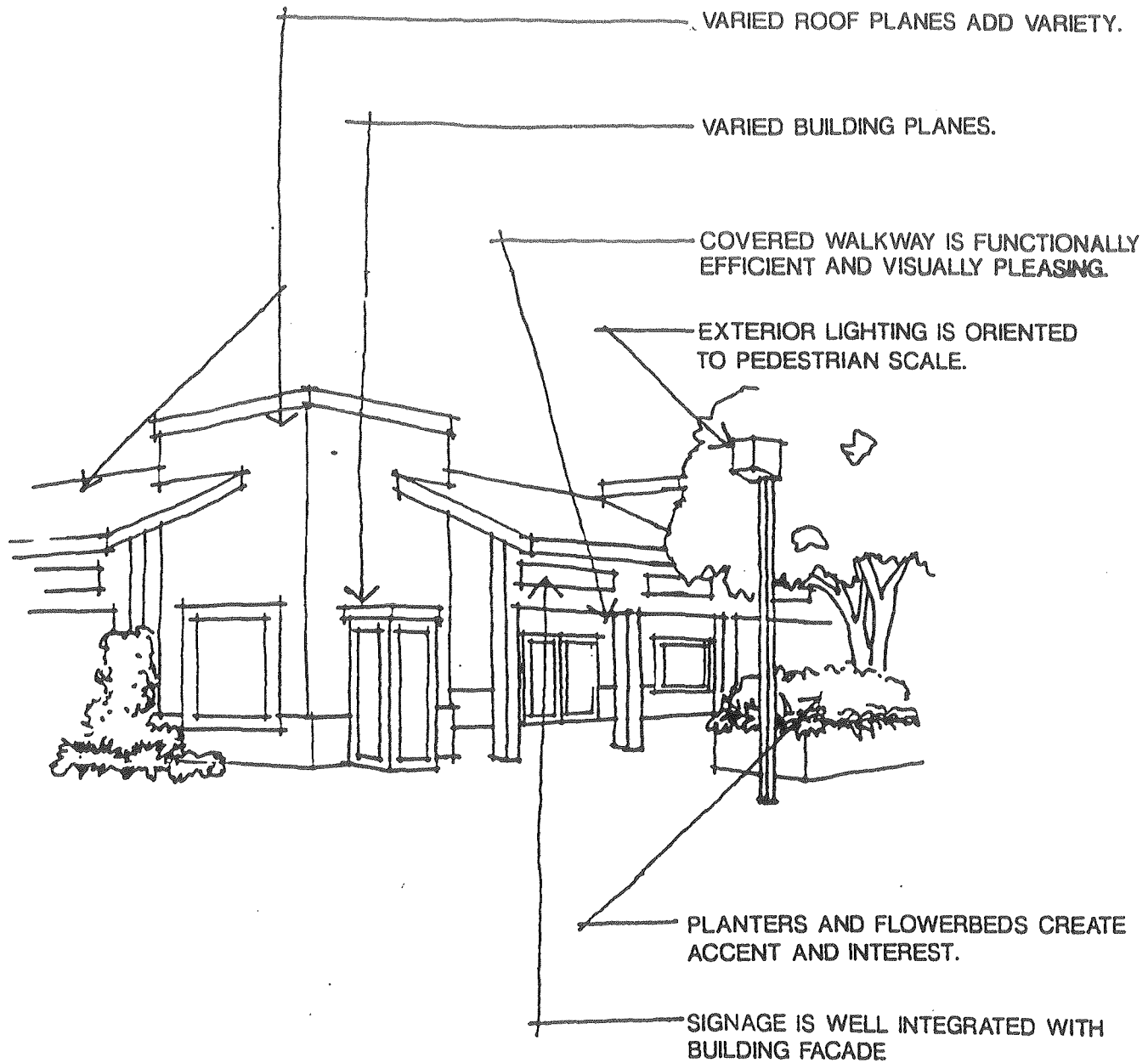

EXHIBIT 23
COMMERCIAL
ARCHITECTURAL
GUIDELINES

UNIVERSITY
PLANNED DEVELOPMENT

FOR: U.C.P. INCORPORATED

b. Design Principles

- 1) The commercial center shall be designed with a consistent, recognizable design theme. The theme shall create a harmonious image through the use of consistent building styles, forms, colors, materials, and roof lines. The architectural theme shall be selected to compliment the early California architectural theme of the project.
- 2) All commercial and office professional development shall be designed in a sensitive manner and compatible with the character of surrounding residential areas.
- 3) Commercial facilities should include plazas, shaded seating areas, bike racks, kiosks, and other public facilities and open spaces.
- 4) Provide for non-motorized access between the commercial facilities and adjacent areas through the interior boundaries of the site, with the intent to connect to nearby trails, greenways and local streets.
- 5) The use of traditional architectural forms shall be encouraged. Pitched roofs, covered walkways, colonnades, entrance pergolas, and the use of indigenous building materials shall be used whenever possible.
- 6) Long and straight building facades facing public view shall be architecturally articulated through the introduction of interest-creating building mass, forms, textures and/or colors.
- 7) Insets, columns, projections and exterior material changes can be used to architecturally demarcate and create interesting building entries. Architectural elements such as colonnades, trellis elements, door and window canopies, and/or arcades, etc., shall be used to provide visual interest to blank building facades.
- 8) Building facades shall be "broken" with reveals, recesses, projections, and other architectural elements designed to provide variety and visual interest to the streetscape. Blank, unarticulated building facades shall be discouraged.

- 9) The mass and scale of buildings shall be proportionate to the site, open spaces, street, and surrounding developments.
- 10) Building exterior openings such as doors or windows can be used in a repetitive pattern to create rhythm.
- 11) Service entries can be shielded from public view by being placed towards the rear and non-public view sides of buildings.
- 12) Service, utility and trash collection areas shall be screened from public view (public streets, parking areas, office pedestrian walks, etc.) by permanent walls and landscaping. Screening walls and landscaping can be integrated with respect to forms and materials with the surrounding architecture and landscaping of parent buildings.
- 13) Retail commercial building exterior design should anticipate signage location, size and coloration so that eventual tenant/occupants can properly provide signage for the buildings. Multi-tenant projects should develop a comprehensive sign program that addresses tenant as well as project sign types and location.
- 14) Fountains, plazas, sculptures, clock towers or other central features shall be used as a focal point or center of confluence for several buildings grouped together.
- 15) Exterior lighting shall be oriented to the pedestrian by utilizing pedestrian scale lamp pole/standards and wall mounted lamps that light adjacent pedestrian walkways.
- 16) A dense landscape buffer shall be required when adjacent to residential uses.
- 17) Transition paving shall be required at all major vehicular entrances. Textured paving shall also be encouraged where pedestrian walkways cross vehicular circulation aisles.

- 18) All mechanical equipment shall be screened from public view. The method of screening shall be architecturally integrated with the main structure in terms of materials, shape, color and size.

c. Building Materials

- 1) Contrasting exterior building materials can be used to create interest and avoid monotony.
- 2) Accent building face areas or accent bands of contrasting materials, patterns, textures or color can be used to create interest, focus, and/or unity.
- 3) Reflective glass-faced buildings should not be used in areas where existing or future surrounding buildings would be adversely affected by glare. Similarly, buildings with large amounts of reflective glass that would cause glare are not appropriate adjacent to areas regularly used by motorists or pedestrians.
- 4) Accent trees, flower beds, special pavement treatments, earth mounding, and special signage can be used to create interest, focus, and set a theme for a project.
- 5) Tree massing, formal plantings, flower beds, sculptures, and special pavement treatments can be used to accent building entries or courtyard areas.

C. GRADING CONCEPT

General grading of the site will be done according to the guidelines below. The intent will be to minimize grading within the site. Exhibit 24 shows the conceptual grading plan, including how some typical section areas may be graded upon establishment of final lot configuration. Please reference Exhibits 25 and 26 for more detail grading concepts. Total cut and fill quantities by Planning Areas are presented in Table 6.

All grading will conform to the latest County standards, Uniform Building Code and the geotechnical report. Slopes between lots could be up to a maximum of 20' except within publicly maintained landscaped areas, which may exceed this height. Per County standards, fill between the site shall not exceed 30'. Grading concepts are designed to respect the City of Rancho Cucamonga grading standards to the extent possible, while meeting the requirements of the County.

INSTEAD OF THIS

DO THIS

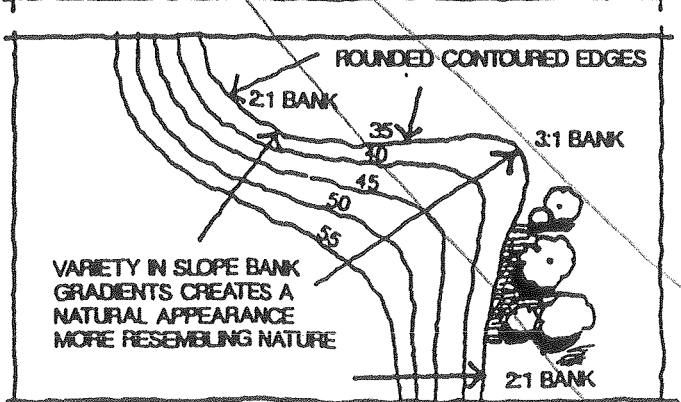
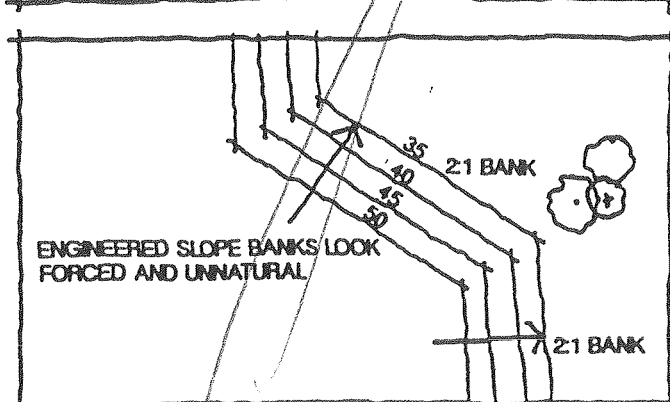
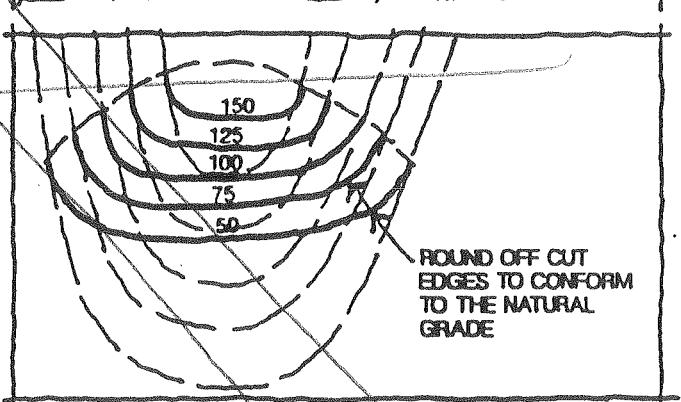
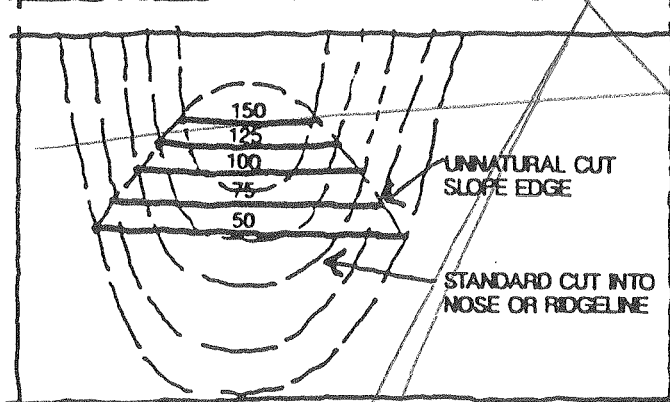
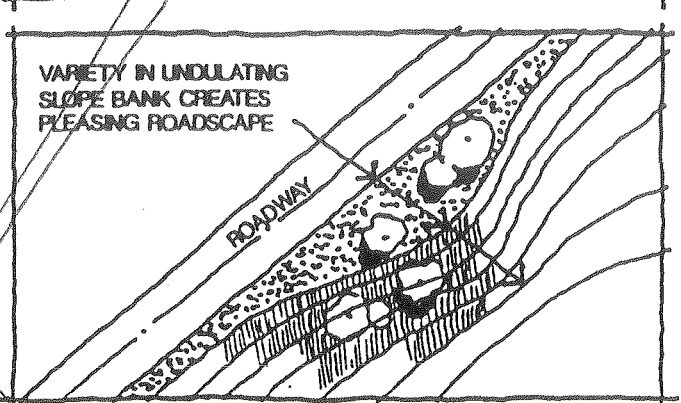
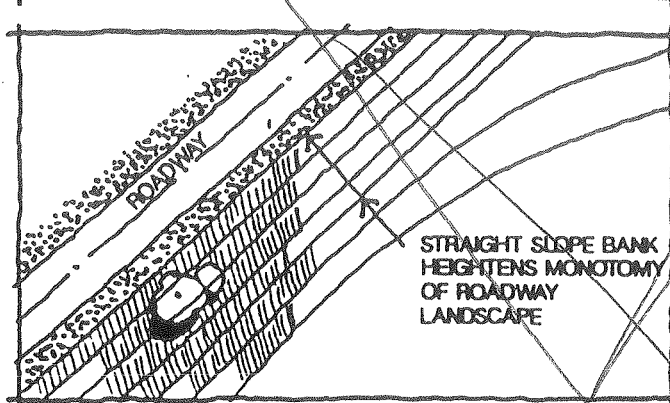
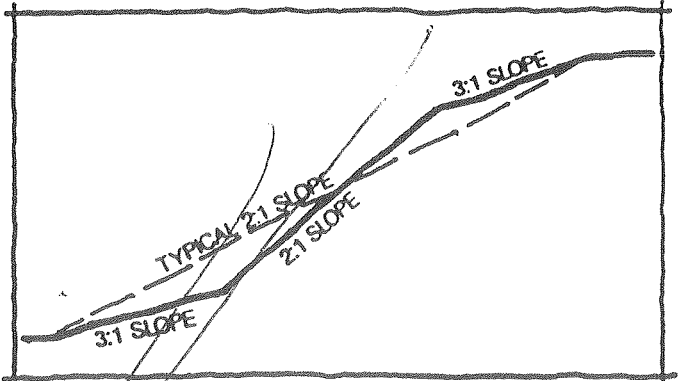
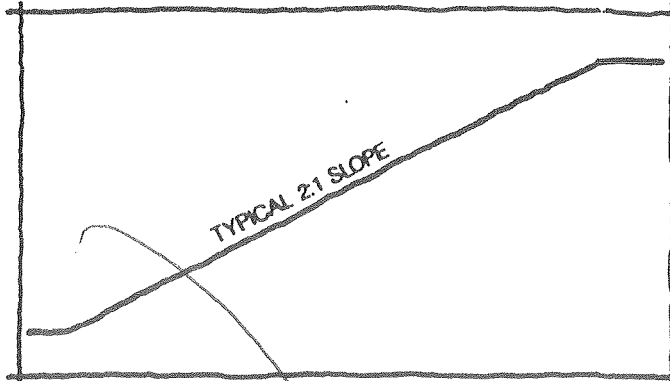
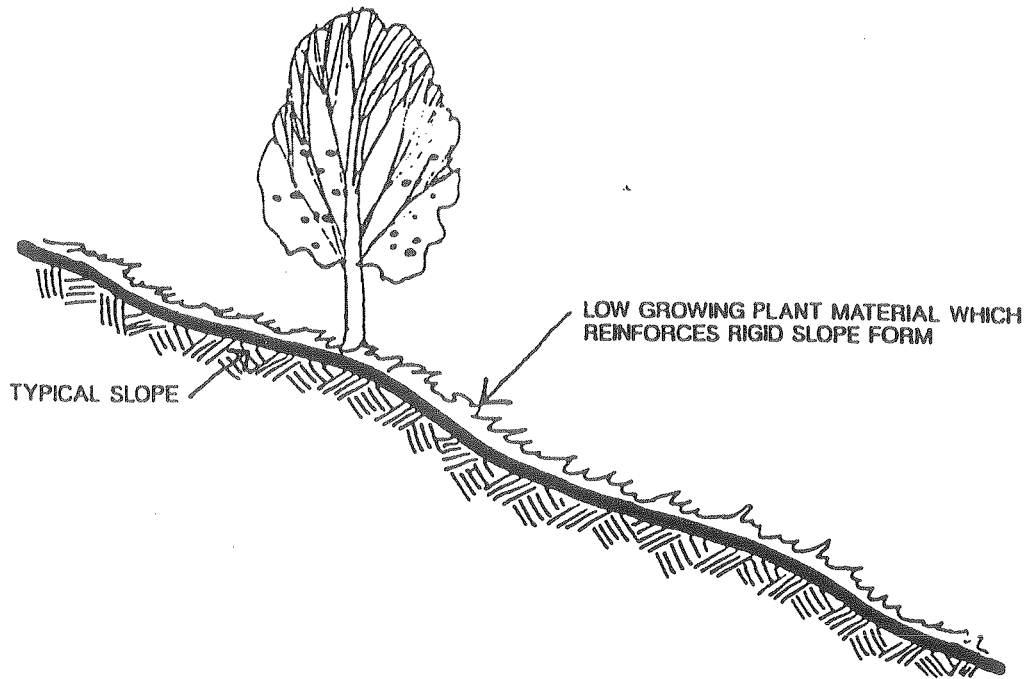

EXHIBIT 25
GRADING
TECHNIQUES

UNIVERSITY
PLANNED DEVELOPMENT

FOR: U.C.P. INCORPORATED

INSTEAD OF THIS



DO THIS

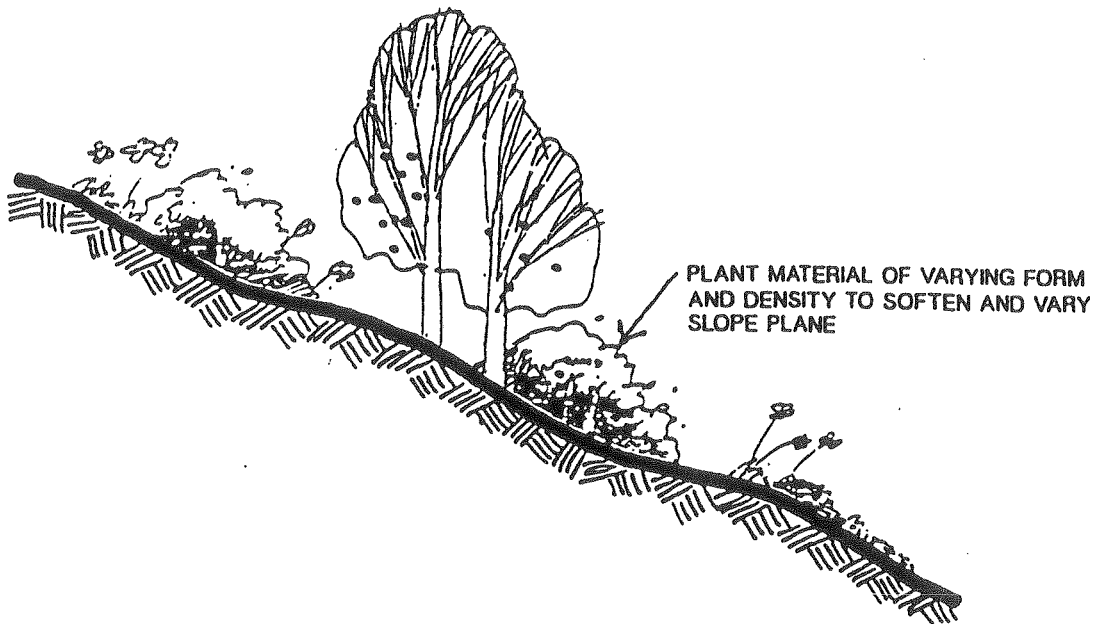

EXHIBIT 26
LANDSCAPE TO
ENHANCE SLOPES

UNIVERSITY
PLANNED DEVELOPMENT

FOR: U.C.P. INCORPORATED

VI. CONSERVATION AND OPEN SPACE

A. PRESERVATION OF NATURAL RESOURCES

1. The West Valley Foothills Planning Area is characterized by a variety of natural resources. The complex hill and canyon landforms which supply the scenic backdrop to the valley floor also provide the natural habitat for wildlife, and the watershed for ground water discharge. Much of the scenic value of the regional planning area today is attributed to its natural features.

In order to preserve a portion of this area, a large area (172 acres) has been proposed as permanent open space (a nature preserve), as discussed in the introduction portion of this report.

To maintain the feeling of the natural landscape and to integrate the revised University PD into the adjacent communities, attention will be given to the use of landscape materials that are native and/or drought tolerant, and which are similar to those found in adjoining communities.

VII. SEISMIC HAZARDS AND PUBLIC SAFETY

A. SUMMARY OF SUBSURFACE ENGINEERING GEOLOGY INVESTIGATION

The purpose of the investigation was to determine whether any active fault traces traverse the site. A previous study done in 1983 identified presence of subtle and discontinuous aerial photograph lineaments traversing the site immediately north of the unpaved extension of 24th Street. This subsurface investigation was intended to address the existence and state of activity of suspected faulting associated with these lineaments.

Approximately 426 feet of trench was excavated in a north to south direction immediately north of unpaved 24th Street. The trench varied from approximately 10 to 15 feet wide at the surface and 10 to 12 feet deep. The alluvial materials observed in the trench consisted of gravel, sands and silty sands with abundant cobbles and boulders up to three feet in diameter.

An analysis of the present stratigraphy was done and although continuous bedding across the entire length of trench was not observed, discontinuous overlapping bedding features such as plan alignments of clasts and sand and gravel lenses were observed throughout most of the length of the trench.

Based on the results of this subsurface investigation and the results of the previous investigations (Rasmussen, February 10, 1986), no evidence has been found to suggest that an active trace of the faulting known to exist east of the site continue to the southwest or west through the site. Therefore, ground rupture due to surface faulting through the site is not expected during the lifetime of the proposed structures.

B. SAFETY FEATURES

The probability for ground acceleration at the site may be considered similar to Southern California as a whole. Horizontal accelerations induced by an earthquake may affect structures and/or earth embankments. Experience has shown that wood frame structures, designed in accordance with the Uniform Building Code, tend to resist earthquake effects. In addition, on-site grading will be limited to a maximum 1-1/2:1 ratio (with approval by a soils engineer and the County of San Bernardino), and will conform to County safety standards.

CREDITS:

PROJECT SPONSOR

U. C. P., Inc.
5109 E. LaPalma Avenue, Suite D
Anaheim, CA 92807
714/ 693-6700
Ben Anderson, Senior Vice President

CIVIL ENGINEERING CONSULTANT

Allard Engineering
6101 Cherry Avenue
Fontana, CA 92336
909/ 899-5011
Raymond Allard, Principal

PLANNING & ENVIRONMENTAL CONSULTANT

Applied Planning, Inc.
2151 East Convention Center Way
Building C, Suite #122
Ontario, CA 91764
909/ 937-0333
Ross S. Geller, Principal

LANDSCAPE CONSULTANT

Laymon Landscape Architects
1 Encina
Irvine, CA 92620
714/ 731-8208
Bill Laymon, Principal

TRAFFIC CONSULTANT

RKJK
1601 Dove Street, Suite 290
Newport Beach, CA 92660
714/ 474-0809
Robert Kahn, Principal

GEOTECHNICAL CONSULTANT

Kleinfelder

720 East Carnegie Drive, Suite 210

San Bernardino, CA 92408

909/ 383-9003

Ricardo Olalde, Operations Manager

UTILITY CONSULTANT

Moran-Palmer

27134 B. Paseo Espada, Suite 201

San Juan Capistrano, CA

714/ 443-3776

Bruce Palmer, Principal

APPENDICES

- A. LEGAL DESCRIPTION - UNIVERSITY (U.C.P)
- B. LANDSCAPE PLANT PALETTE
- C. TRAFFIC STUDY (Separate Cover)
- D. PRELIMINARY GEOTECHINICAL FEASIBILITY EVALUATION
(Separate Cover)
- E. BIOLOGICAL RESOURCES ASSESSMENT (Separate Cover)
- F. ACOUSTICAL STUDY (Separate Cover)
- G. AIR QUALITY IMPACT ASSESSMENT STUDY (Separate Cover)

APPENDIX A

LEGAL DESCRIPTION

UCP owned property is described as follows:

BEING A SUBDIVISION OF A PORTION OF SECTIONS 20 AND 29, TOWNSHIP 1 NORTH, RANGE 6 WEST, SAN BERNARDINO BASE AND MERIDIAN, IN SAN BERNARDINO COUNTY, IN THE STATE OF CALIFORNIA.

Excepting therefrom the Intex owned properties further described as follows:

THE SOUTH $\frac{1}{2}$ OF THE SOUTHEAST $\frac{1}{4}$ OF THE SOUTHWEST $\frac{1}{4}$ OF THE NORTHWEST $\frac{1}{4}$ OF SECTION 29 AND THE NORTH $\frac{1}{2}$ OF THE NORTHEAST $\frac{1}{4}$ OF THE NORTHWEST $\frac{1}{4}$ OF THE SOUTHWEST $\frac{1}{4}$ OF SECTION 29 AND THE SOUTH $\frac{1}{2}$ OF THE SOUTHWEST $\frac{1}{4}$ OF THE SOUTHEAST $\frac{1}{4}$ OF THE NORTHWEST $\frac{1}{4}$ OF SECTION 29 EXCEPTING THE WESTERLY 330 FEET, ALL IN TOWNSHIP 1 NORTH, RANGE 6 WEST, SAN BERNARDINO BASE AND MERIDIAN, IN SAN BERNARDINO COUNTY, IN THE STATE OF CALIFORNIA.

Open space property is described as follows:

THAT PORTION OF THE EAST $\frac{1}{2}$ OF THE SOUTHEAST $\frac{1}{4}$ OF THE SECTION 15, TOWNSHIP 1 NORTH, RANGE 6 WEST, SAN BERNARDINO BASE AND MERIDIAN, IN THE COUNTY OF SAN BERNARDINO, STATE OF CALIFORNIA, ACCORDING TO GOVERNMENT SURVEY, LYING SOUTHERLY OF THE SOUTHERLY LINE OF THAT CERTAIN STRIP OF LAND, 450 FEET IN WIDTH, AS CONVEYED TO THE CITY OF LOS ANGELES, A MUNICIPAL CORPORATION, BY DEED RECORDED AUGUST 19, 1987, INSTRUMENT NO. 87-286120, OFFICIAL RECORDS, AND THE EAST $\frac{1}{2}$ OF THE EAST $\frac{1}{2}$ OF SECTION 22, TOWNSHIP 1 NORTH, RANGE 6 WEST, SAN BERNARDINO BASE AND MERIDIAN, IN THE COUNTY OF SAN BERNARDINO, STATE OF CALIFORNIA, ACCORDING TO GOVERNMENT SURVEY.

APPENDIX B

PLANT PALETTE

L.M.D LANDSCAPE AREAS

MAINTAINED BY LANDSCAPE MAINTENANCE DISTRICT

TREES

*ALBIZIA JULIBRISSIN	SILK TREE
BRACHYCHITON ACERIFOLIUS	FLAME TREE
BRACHYCHITON POPULEUS	BOTTLE TREE
*CERCIS OCCIDENTALIS	WESTERN RED BUD
CINNAMOMUM CAMPHORA	CAMPHOR TREE
EUCALYPTUS SPECIES	EUCALYPTUS
*GEIJERA PARVIFLORA	AUSTRALIAN WILLOW
GINKGO BILOBA	MAIDENHAIR TREE (MALE ONLY)
*KOELREUTERIA BIPINNATA	CHINESE FLAME TREE
*KOELREUTERIA PANICULATA	GOLDEN RAIN TREE
*LAGERSTROEMIA INDICA	CRAPE MYRTLE
LIQUIDAMBAR STYRACIFLUA	SWEET GUM
MAGNOLIA GRANDIFLORA	SOUTHERN MAGNOLIA
PINUS CANARIENSIS	CANARY ISLAND PINE
PINUS HALEPENSIS	ALEPPO PINE
*PISTACIA CHINENSIS	CHINESE PISTACHE (MALE ONLY)
PLATANUS ACERIFOLIA	LONDON PLANE TREE
PLATANUS RACEMOSA	CALIFORNIA SYCAMORE
*PRUNUS ILICIFOLIA	HOLLYLEAF CHERRY
*PYRUS CALLERYANA "BRADFORD"	BRADFORD PEAR
QUERCUS ILEX	HOLLY OAK
*RHUS LANCEA	AFRICAN SUMAC
*SOPHORA JAPONICA	JAPANESE PAGODA
WASHINGTONIA FILIFERA	CALIFORNIA FAN PALM
WASHINGTONIA ROBUSTA	MEXICAN FAN PALM

* Considered small trees

INTRACT STREET TREE PALETTE (NON L.M.D. AREAS)

ALBIZIA JUIBRISSIN	SILKTREE
CINNAMOMUM CAMPHORA	CAMPHOR TREE
KOELREUTERIA BIPINNATA	CHINESE FLAME TREE
KOELREUTERIA PANICULATA	GOLDEN RAIN TREE
LAGERSTROEMIA INDICA	CRAPE MYRTLE
LIQUIDAMBAR STYRACIFLUA	SWEET GUM
MAGNOLIA GRANDIFLORA	SOUTHERN MAGNOLIA
PISTACIA CHINENSIS	CHINESE PISTACHE
PLATANUS ACERFOLIA	LONDON PLANE TREE
QUERCUS ILEX	HOLLY OAK
RHUS LANCEA	AFRICAN SUMAC
SOPHORA JAPONICA	JAPANESE PAGODA TREE

TYPICAL INTERIOR SLOPES (NON L.M.D. AREAS)

MAINTAINED BY HOMEOWNER, LANDSCAPED AND IRRIGATED PER SAN BERNARDINO COUNTY STANDARDS.

TREES

ALBAZIA JULIBRISSIN	SILK TREE
CERCIS OCCIDENTALIS	WESTERN RED BUD
EUCALYPTUS SPECIES	EUCALYPTUS
LAGERSTROEMIA INDICA	CRAPE MYRTLE
LIQUID AMBAR STYRACIFLUA	SWEET GUM
PINUS HALEPENISIS	ALEPPO PINE

SHRUBS

ACACIA REDOLENS	NO COMMON NAME
CEANOOTHUS SPECIES	CALIFORNIA LILAC
CISTUS SPECIES	ROCKROSE
COTONEASTER SPECIES	COTONEASTER
DODONAEA VISCOSA	HOPSEED BUSH
ELAEAGNUS PUNGENS	SILVER BERRY
PITTOSPORUM TOBIRA	MOCK ORANGE
PITTOSPORUM TOBIRA "VARIEGATA"	VARIEGATED PITTOSPORUM
RAPHOLEPIS INDICA	PINK INDIA HAWTHORNE
XYLOSMA CONGESTUM	XYLOSMA

GROUND COVER

ARCTOSTAPHYLOS SPECIES	MANZANITA
BACCHARIS PILULARIS "TWIN PEAKS"	COYOTE BUSH
CEANOOTHUS SPECIES	CALIFORNIA LILAC
ESCHSCHOLIZA CALIFORNICA	CALIFORNIA POPPY
GAZANIA SPECIES	AFRICAN DAISY
HYPERICUM CALYGINUM	AARON'S BEARD
MYOPORUM PARVIFOLIUM	NO COMMON NAME
TRIFOLIUM FRAGIFERUM	NO COMMON NAME

