



THE RESORT SPECIFIC PLAN

PLANNING AREA 1A MIXED USE INFILL AREA

City Council Adopted: July 20, 2022
Ordinance 1007, Case DRC2020-00164

A reformatting of the approved Industrial Area Specific Plan Sub Area 18: Section 7 - Planning Area 1 to split the approved Specific Plan into two sections, Planning Area 1A & 1B

PA 1A is devoted to the property located South of 6th Street.

PA 1B is devoted to the property located North of 6th Street.

Table of Contents

<u>8.1 Introduction</u>	<u>8-1</u>
<u>8.1.1 Specific Plan Context</u>	<u>8-2</u>
<u>8.2 Community Vision</u>	<u>8-4</u>
<u>8.2.1 Design Goals</u>	<u>8-4</u>
<u>8.2.2 Community Framework</u>	<u>8-10</u>
<u>8.3 Urban Design Standards.....</u>	<u>8-14</u>
<u>8.3.1 Development Potential</u>	<u>8-15</u>
<u>8.3.2 Placetype Descriptions.....</u>	<u>8-18</u>
<u>8.3.3 Land Use</u>	<u>8-34</u>
<u>8.3.4 Development Standards.....</u>	<u>8-34</u>
<u>8.3.5 Parking Requirements.....</u>	<u>8-45</u>
<u>8.3.6 Circulation.....</u>	<u>8-52</u>
<u>8.4 Architectural Guidelines</u>	<u>8-77</u>
<u>8.4.1 Site Planning Criteria.....</u>	<u>8-78</u>
<u>8.4.2 Scale, Massing, and Articulation.....</u>	<u>8-80</u>
<u>8.4.3 Roofs</u>	<u>8-85</u>
<u>8.4.4 Private Drive Aisle & Alley Treatments.....</u>	<u>8-87</u>
<u>8.4.5 Architectural Detailing.....</u>	<u>8-88</u>
<u>8.4.6 Trash Enclosures.....</u>	<u>8-91</u>
<u>8.4.7 Service and Loading.....</u>	<u>8-91</u>
<u>8.4.8 Elevations and Color Application.....</u>	<u>8-92</u>

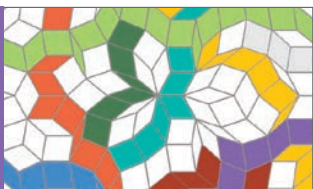

8.4.9 Architectural Styles	8-93
Art Deco.....	8-96
Art Deco Style Elements.....	8-97
Contemporary.....	8-98
Contemporary Style Elements.....	8-99
Industrial.....	8-100
Industrial Style Elements.....	8-101
Craftsman.....	8-102
Craftsman Style Elements.....	8-103
European Heritage.....	8-104
European Heritage Style Elements.....	8-105
Italian	8-106
Italian Style Elements	8-107
Main Street.....	8-108
Main Street Style Elements.....	8-109
Monterey	8-110
Monterey Style Elements	8-111
Prairie	8-112
Prairie Style Elements.....	8-113
Spanish	8-114
Spanish Style Elements.....	8-115
8.5 Landscape Design.....	8-116
8.5.1 Landscape Placemaking.....	8-117
8.5.2 Landscape Guidelines.....	8-130
8.5.3 Community Walls and Fencing.....	8-138
8.5.4 Urban Lighting Design.....	8-140
8.5.5 Signs	8-141
8.6 Public Safety.....	8-143
8.6.1 Fire Protection	8-143
8.6.2 Law Enforcement and Crime Prevention.....	8-144

<u>8.7 Implementation.....</u>	<u>8-145</u>
<u>8.7.1 Intensity Monitoring Program.....</u>	<u>8-146</u>
<u>8.7.2 Definition of Terms.....</u>	<u>8-148</u>
<u>8.7.3 Financing and Maintenance of Improvements.....</u>	<u>8-148</u>
<u>8.7.4 Phasing.....</u>	<u>8-151</u>
<u>8.7.5 ALUCP Compliance.....</u>	<u>8-151</u>
<u>8.7.6 Severability.....</u>	<u>8-152</u>
<u>8.7.7 Interpretation.....</u>	<u>8-153</u>
<u>8.8 Glossary.....</u>	<u>8-154</u>
<u>Appendix A Engineering.....</u>	<u>A-1</u>
<u>1.0 Grading.....</u>	<u>A-2</u>
<u>2.0 Storm Drainage.....</u>	<u>A-10</u>
<u>3.0 Storm Water Quality.....</u>	<u>A-15</u>
<u>4.0 Sanitary Sewer.....</u>	<u>A-18</u>
<u>5.0 Domestic Water.....</u>	<u>A-22</u>
<u>6.0 Recycled Water.....</u>	<u>A-28</u>
<u>7.0 Street Improvement.....</u>	<u>A-32</u>
<u>8.0 Dry Utilities.....</u>	<u>A-36</u>
<u>Appendix B Plant Palette.....</u>	<u>A-37</u>
<u>Appendix C General Plan Amendment.....</u>	<u>A-49</u>
<u>Appendix D General Plan Consistency.....</u>	<u>A-63</u>
<u>1.0 General Plan Consistency.....</u>	<u>A-64</u>
<u>Appendix E Zoning Code Amendment.....</u>	<u>A-75</u>
<u>Section 17.38.070 Rancho Cucamonga IASP Sub-Area 18 Specific Plan.....</u>	<u>A-76</u>

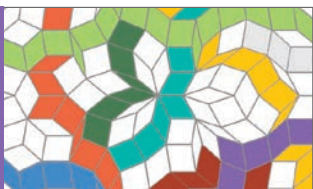

“Strike-through” Figures denote removal from document, they are not applicable to this Specific Plan Amendment, Adopted July 20, 2022.

City Council Adopted: July 20, 2022
Ordinance 1007, Case DRC2020-00164

List of Tables

<u>Table 8.1: PAIA Development Program.....</u>	<u>8-17</u>
<u>Table 8.2: MU Overlay Standards</u>	<u>8-32</u>
<u>Table 8.3: Development Standards.....</u>	<u>8-35</u>
<u>Table 8.4: Permitted Encroachments.....</u>	<u>8-38</u>
<u>Table 8.5: Perimeter Setbacks.....</u>	<u>8-40</u>
<u>Table 8.6: Parking Standards.....</u>	<u>8-46</u>
<u>Table 8.8A: Specific Tiered Landscaping Requirements For Yards.....</u>	<u>8-137</u>
<u>Table 8.7: General Tiered Landscaping Requirements.....</u>	<u>8-137</u>
<u>Table 8.8B: Specific Tiered Landscaping Requirements For Open Spaces.....</u>	<u>8-137</u>
<u>Table 8.9: Intensity Monitoring Program.....</u>	<u>8-147</u>
<u>Table B-1: Permitted Streetscape Tree List</u>	<u>A-38</u>
<u>Table B-2: Permitted Plant List</u>	<u>A-39</u>
<u>Table 17.38.070-1: Allowed Land Uses and Permit Requirements by Placetype.....</u>	<u>A-78</u>

List of Figures

<u>Figure 8.1: Planning Area I.....</u>	<u>8-1</u>
<u>Figure 8.2: PAIA Context</u>	<u>8-3</u>
<u>Figure 8.3: Design Concept.....</u>	<u>8-5</u>
<u>Figure 8.4: Regional Activity Context.....</u>	<u>8-6</u>
<u>Figure 8.5: Conceptual Vine.....</u>	<u>8-11</u>
<u>Figure 8.6: Conceptual Development Plan by Placetype.....</u>	<u>8-16</u>
<u>Figure 7.7: Conceptual Transit Placetype Plan & Sections.....</u>	<u>8-21</u>
<u>Figure 8.8: Conceptual Mixed Use Placetype Plan & Section</u>	<u>8-23</u>
<u>Figure 7.9: Conceptual Urban Neighborhood Placetype Plan & Section.....</u>	<u>8-25</u>
<u>Figure 8.10: Conceptual Core Living Placetype Plan & Sections</u>	<u>8-27</u>

<u>Figure 8.11: Conceptual Village Neighborhood Placetype</u>	
<u> Plan & Section</u>	<u>8-29</u>
<u>Figure 7.12: Conceptual Recreation Placetype Plan & Section</u>	<u>8-31</u>
<u>Figure 8.13: Conceptual Mixed Use Overlay Placetype Plan</u>	<u>8-33</u>
<u>Figure 8.14 Distance Between Building/Structure</u>	<u>8-37</u>
<u>Figure 8.15 Minimum Building Setbacks</u>	<u>8-38</u>
<u>Figure 8.16: Encroachment Diagrams</u>	<u>8-39</u>
<u>Figure 8.17: Setback Locations</u>	<u>8-40</u>
<u>Figure 8.18A: Primary Edge Section</u>	<u>8-41</u>
<u>Figure 8.18B: Residential Edge Section</u>	<u>8-41</u>
<u>Figure 7.19: Rail Road Edge Section</u>	<u>8-42</u>
<u>Figure 8.20: Driveway/Garage Door Setbacks</u>	<u>8-49</u>
<u>Figure 8.21: Transit Circulation</u>	<u>8-52</u>
<u>Figure 8.22: Overall Circulation Diagram</u>	<u>8-53</u>
<u>Figure 8.23: Bicycle Circulation Diagram</u>	<u>8-55</u>
<u>Figure 8.24: Pedestrian Circulation Diagram</u>	<u>8-56</u>
<u>Figure 8.25: Conceptual Ion Sections</u>	<u>8-58</u>
<u>Figure 8.26: Conceptual Ion Plan</u>	<u>8-59</u>
<u>Figure 8.27: Conceptual Table Top Pedestrian Crossing Rendering</u>	<u>8-60</u>
<u>Figure 8.28: Table Top Pedestrian Crossing/Tapered Street</u>	<u>8-61</u>
<u>Figure 8.29: Vehicular Circulation Diagram</u>	<u>8-62</u>
<u>Figure 8.30: Conceptual Vine Rendering</u>	<u>8-63</u>
<u>Figure 8.31: The Vine</u>	<u>8-64</u>
<u>Figure 8.32: Typical Roundabout Plan</u>	<u>8-65</u>
<u>Figure 8.33: 6th Street</u>	<u>8-66</u>
<u>Figure 8.34: 6th Street Intersection</u>	<u>8-67</u>
<u>Figure 8.35: 4th Street</u>	<u>8-68</u>
<u>Figure 8.36: 4th Street Intersection</u>	<u>8-69</u>
<u>Figure 7.37: Secondary Entry Road 'A'</u>	<u>8-70</u>

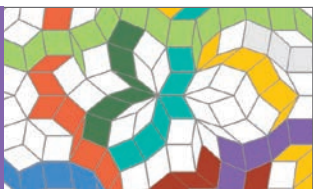

<u>Figure 7.38: Secondary Entry Road 'B'</u>	8-71
<u>Figure 7.39: Secondary Entry Road 'C'</u>	8-72
<u>Figure 8.40: Collector Road</u>	8-73
<u>Figure 8.41: Private Drive Aisle</u>	8-74
<u>Figure 8.42: Private Drive Aisle at PAI Boundary</u>	8-75
<u>Figure 8.43: Alley Section</u>	8-76
<u>Figure 8.44: Urban Framework Diagram</u>	8-79
<u>Figure 8.45: Massing and Articulation Diagram</u>	8-83
<u>Figure 8.46: Material Wrapping Diagram</u>	8-89
<u>Figure 8.47: Conceptual Vine 3rd Place Space Plaza Rendering</u>	8-118
<u>Figure 8.48: Conceptual Vine</u>	8-119
<u>Figure 7.49: Conceptual 6th Street East Urban Plaza</u>	8-120
<u>Figure 8.50: Conceptual Grand Paseo</u>	8-123
<u>Figure 8.51: Pathway Diagram</u>	8-124
<u>Figure 8.52: Pedestrian Connection to Adjacent Property</u>	8-125
<u>Figure 8.53: Conceptual Gathering Space</u>	8-126
<u>Figure 8.54: Conceptual Bark Park</u>	8-128
<u>Figure A-1: Conceptual Phase 1 Grading Plan</u>	A-4
<u>Figure A-2: Conceptual Phase 1 Cut/Fill Plan</u>	A-5
<u>Figure A-3: Conceptual Phase 2 Grading Plan</u>	A-6
<u>Figure A-4: Conceptual Phase 2 Cut/Fill Plan</u>	A-7
<u>Figure A-5: Conceptual Phase 3 Grading Plan</u>	A-8
<u>Figure A-6: Conceptual Phase 3 Cut/Fill Plan</u>	A-9
<u>Figure A-7: Conceptual Phase 1 Storm Drain Facilities Plan</u>	A-11
<u>Figure A-8: Conceptual Phase 1 Interim Grading</u> <u>Storm Drain Facilities Plan</u>	A-12
<u>Figure A-9: Conceptual Phase 2 Storm Drain Facilities Plan</u>	A-13
<u>Figure A-10: Conceptual Phase 3 Storm Drain Facilities Plan</u>	A-14
<u>Figure A-11: Conceptual Storm Water Quality Management Plan</u>	A-17

[Figure A-12: Conceptual Phase 1 Sanitary Sewer Facilities Plan.....A-19](#)
[Figure A-13: Conceptual Phase 2 Sanitary Sewer Facilities Plan.....A-20](#)
[Figure A-14: Conceptual Phase 3 Sanitary Sewer Facilities Plan.....A-21](#)
[Figure A-15: Conceptual Phase 1 Domestic Water Facilities PlanA-25](#)
[Figure A-16: Conceptual Phase 2 Domestic Water Facilities Plan.....A-26](#)
[Figure A-17: Conceptual Phase 3 Domestic Water Facilities Plan.....A-27](#)
[Figure A-18: Conceptual Phase 1 Recycled Water Facilities Plan.....A-29](#)
[Figure A-19: Conceptual Phase 2 Recycled Water Facilities Plan.....A-30](#)
[Figure A-20: Conceptual Phase 3 Recycled Water Facilities Plan.....A-31](#)
[Figure A-21: Conceptual Phase 1 Street Improvement Facilities Plan....A-33](#)
[Figure A-22: Conceptual Phase 2 Street Improvement Facilities Plan..A-34](#)
[Figure A-23: Conceptual Phase 3 Street Improvement Facilities Plan..A-35](#)

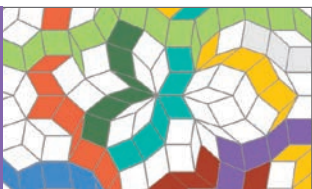

8.1 Introduction

On October 7, 2020, the City and the Property Owners, SC Rancho Development Corp. and Empire Lakes Holding Company, LLC, entered into a First Amendment to Development Agreement NO. DRC 2015-00118 regarding the Empire Lakes Specific Plan (the "First Amendment"). Exhibit B to the First Amendment presented a conceptual Framework Plan amending the Specific Plan's street network, alignments, and connections within Planning Area 1 north of 6th Street. At that time, it was contemplated the approved Sub-Area 18-Section 7 of the IASP Specific Plan would be amended to include the new Framework Plan for the portion of the property located north of 6th Street. This document is intended to implement the Framework Plan as required by the First Amendment.

To provide more clarity to the reader, City Staff requested the Specific Plan be "reformatted into two new sections, one for the area south of 6th Street and one for the area north of 6th Street. The approved Sub-Area 18-Section 7 document has been reformatted into two new sections, Section 8 for the property south of 6th street and Section 9 for the property north of 6th street mirroring the new Framework Plan. The property within Section 8 is has been designated as Planning Area 1A and the property within Section 9 as Planning Area 1B. Collectively, Section 8 and Section 9 will now be referred to as The Resort Specific Plan. The modifications to the street network outlined in the Framework Plan do not constitute a substantial change requiring revisions to the Empire Lakes Specific Plan Amendment Final EIR.

Section 7 previously consolidated all land use and development plan details for Planning Areas IA, IB, and portions of Planning Area III and Planning Area VI into a single Planning Area I (PAI) representing the entire 160.4 acres of the existing golf course. Section 8 and 9 will now designate the property south of 6th Street as Planning Area IA and the property north of 6th Street as Planning area IB respectively.

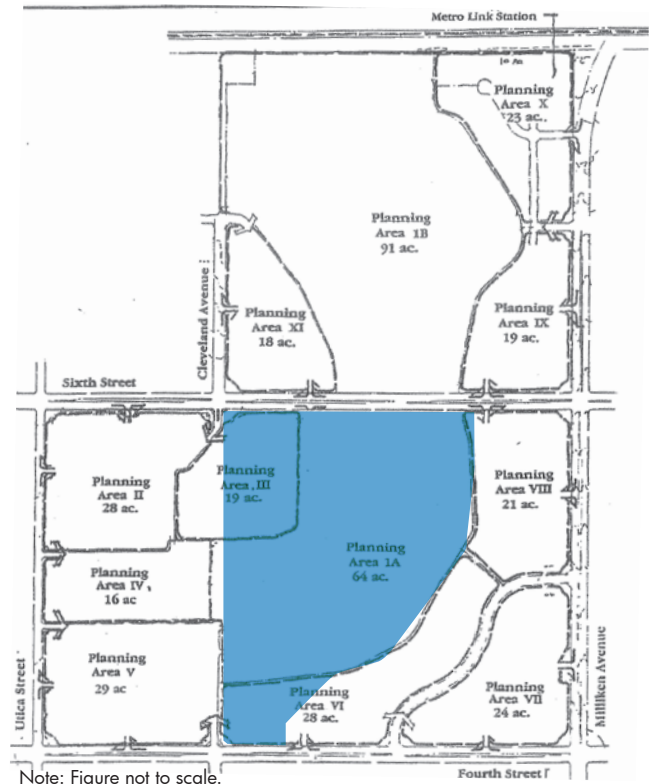

Figure 8.1: Planning Area I

The goal of Section 8 and 9 is to support smart growth in the City by locating urban housing in proximity to transit, employment, and regional entertainment; see Figure 8.4: Regional Activity Context. All maps, development standards, and guidelines related to PAIA are in this section. The project applicant controls all of PA1A and PA1B. All references to "Mixed Use Infill Area," "PAIA," and Section 8 in the first six sections of the Specific Plan refer to this section. This section also provides a unifying vision with standards and guidelines that continue the objectives of the IASP. PAIA is designed to foster an integrated environment that responds to evolving market conditions and combines progressive development patterns with environmental stewardship to create active residential neighborhoods designed at a human scale.

8.11 Specific Plan Context

The Specific Plan was originally adopted in January 1994 to regulate the redevelopment of the General Dynamics property. Since adoption, the Specific Plan was developed with office, medium-density residential, and golf course uses. The Specific Plan has been amended six times in 2000, 2001, 2002, 2003, 2012 and 2016, to facilitate property build-out responsive to market conditions.

The site is surrounded by well-planned and built-out properties with a mix of residential, office, commercial, and entertainment uses all within proximity to freeways and transit services. The property within Planning Area IA (Section 8) has been fully improved and is partially built out. The property within Planning Area 1B (Section 9) has been partially improved and has yet to be built out.

Consistent with the vision and goals of the IASP, this section provides a Mixed-Use Infill Area development plan and guidelines for Planning Areas IA and 1B to leverage its location and access to existing transit services and commercial areas.

A. Proposed Amendment

The adoption of this Specific Plan amendment by ordinance will reformat the approved Specific Plan into two sections, Section 8 and Section 9. This amendment also streamlines the review process for projects within PA's IA and 1B using City of Rancho Cucamonga Planning Department procedures which minimizes additional processing review steps.



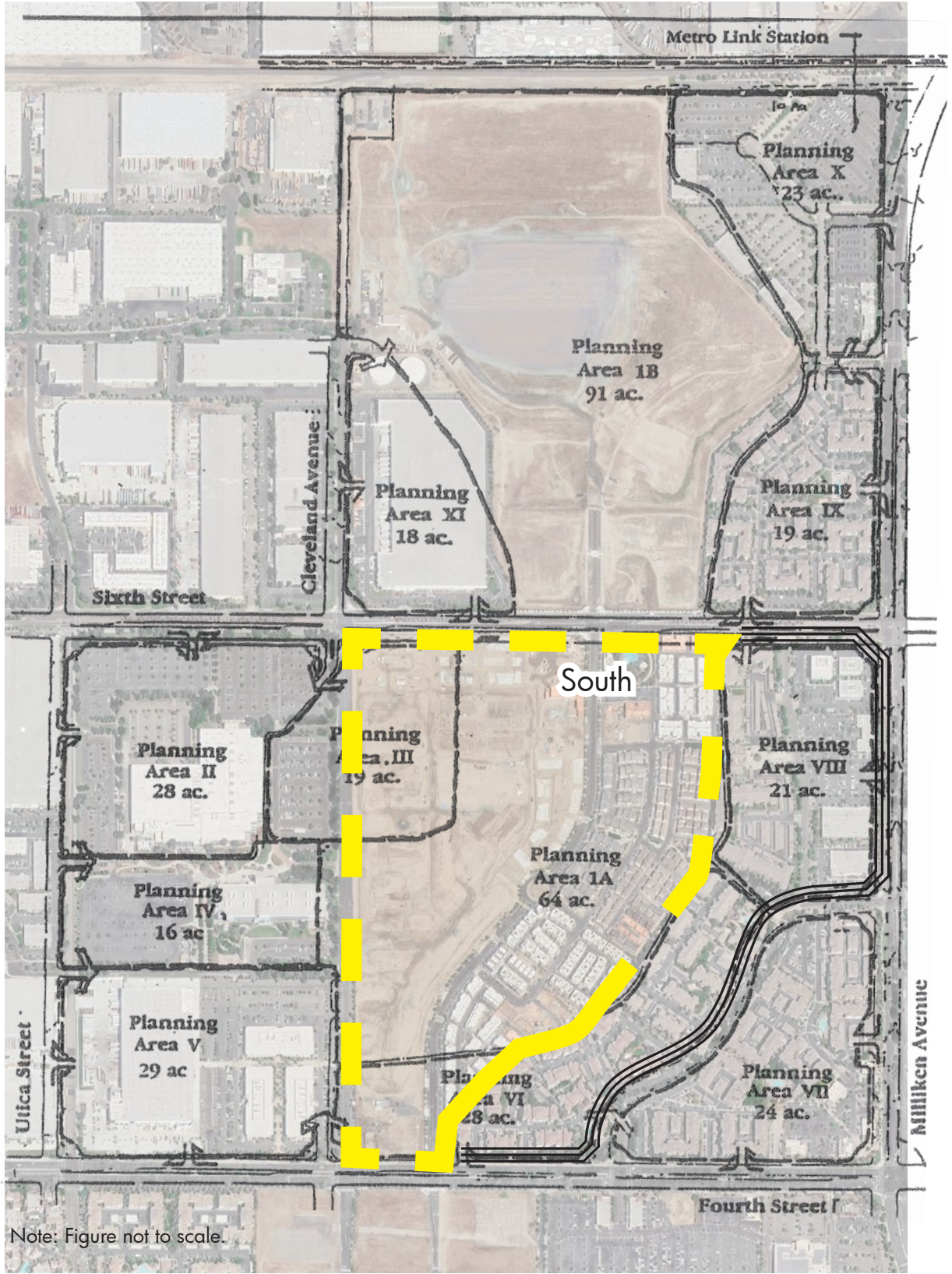

Figure 8.2: PAIA Context

8.2 Community Vision

PAIA is envisioned as a walkable mixed use community in close proximity to the Metrolink Rancho Cucamonga Station (Metrolink station). The plan provides daily lifestyle elements in a setting where the spaces for living and playing are intimate, personal, and connected. High-density homes will be within walking or biking distance to transit, existing local job centers, mixed use areas, commercial services, and recreation amenities through a comprehensive connective 3rd Place network. Community programming will generate a dynamic built environment with people-places, fostering an active lifestyle, and providing access to transportation solutions. See Figure 8.3: Design Concept for design concepts.

8.2.1 Design Goals

The following are the fundamental goals for community design:

Incorporate Placetype concepts in a dynamic urban setting in the City of Rancho Cucamonga.

PAIA is planned as a mixed use village, providing a range of opportunities for a variety of living, recreational, and working settings. This village is surrounded by regional shopping, medium- to high-density residential, a range of large-format commercial and industrial employers, and various community services and amenities. Repurposing the existing golf course into a mixed use village within this highly active regional area will provide a range of living options near existing employment, transit, and entertainment as shown on Figure 8.4: Regional Activity Context.

Placetypes

Placetypes are a progressive means of regulating the built environment. Placetypes integrate development principles, built form guidelines, and design criteria to create holistic people-centric places instead of using traditional land use-centric regulations.

The development plan for PAIA uses a Placetype-based regulating plan to establish the minimum design parameters and land use options.



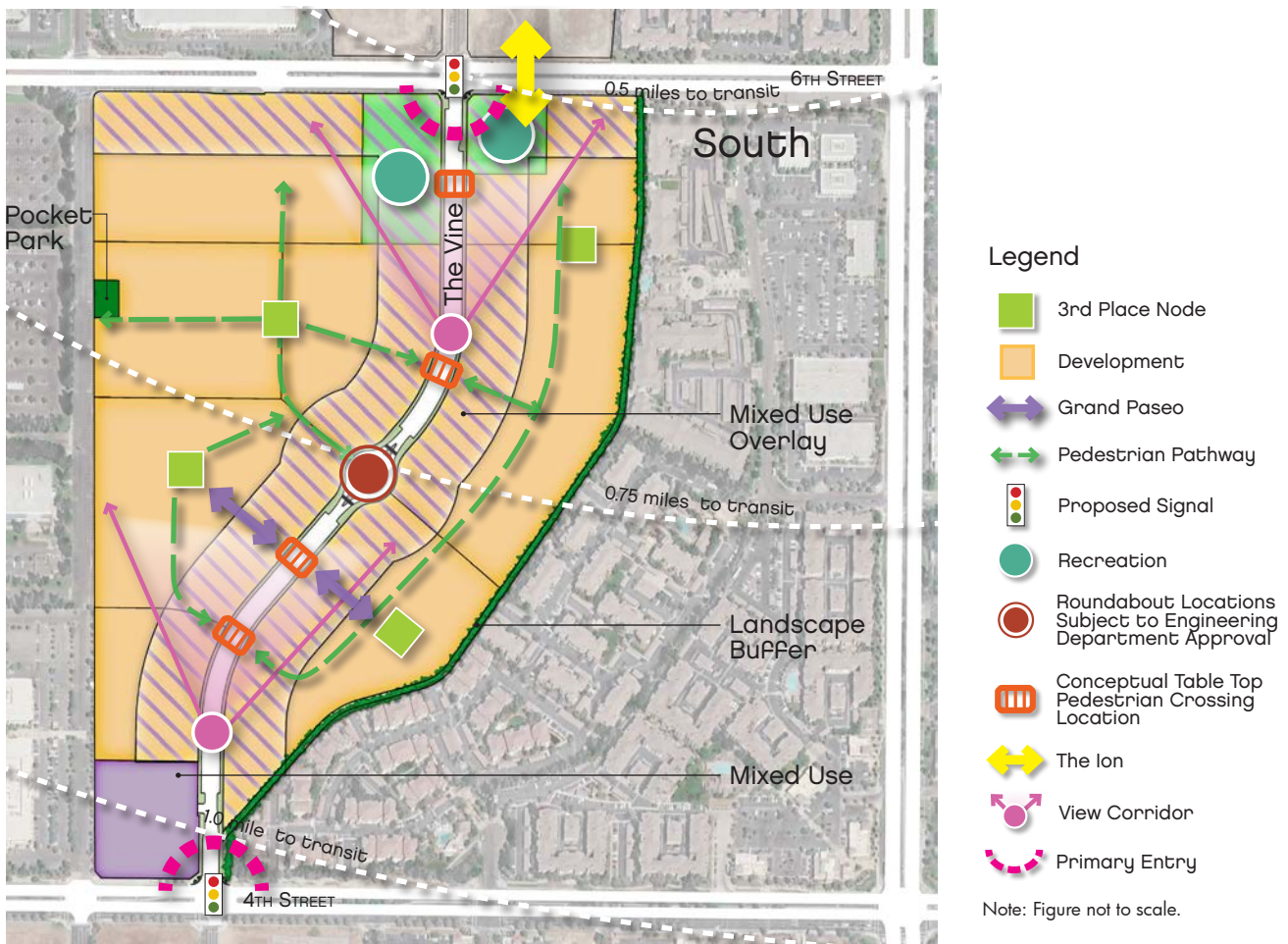

Figure 8.3: Design Concept

The distinctly urban setting is defined by higher densities; a variety of development configurations, building types, and mixed intensities; and walkable pedestrian realm interfaces. Additional neighborhood and community amenities in close proximity to PAIA include:

- Adult Sports Park, approximately 2.3 miles away.
- Milliken Park and Ralph M. Lewis Park, approximately 2.5 miles away.
- Central Park community center, approximately 3.5 miles away.
- Fire Station 174 at the corner of Milliken and Jersey Boulevard.
- Cucamonga Elementary School.
- Rancho Cucamonga Middle School.

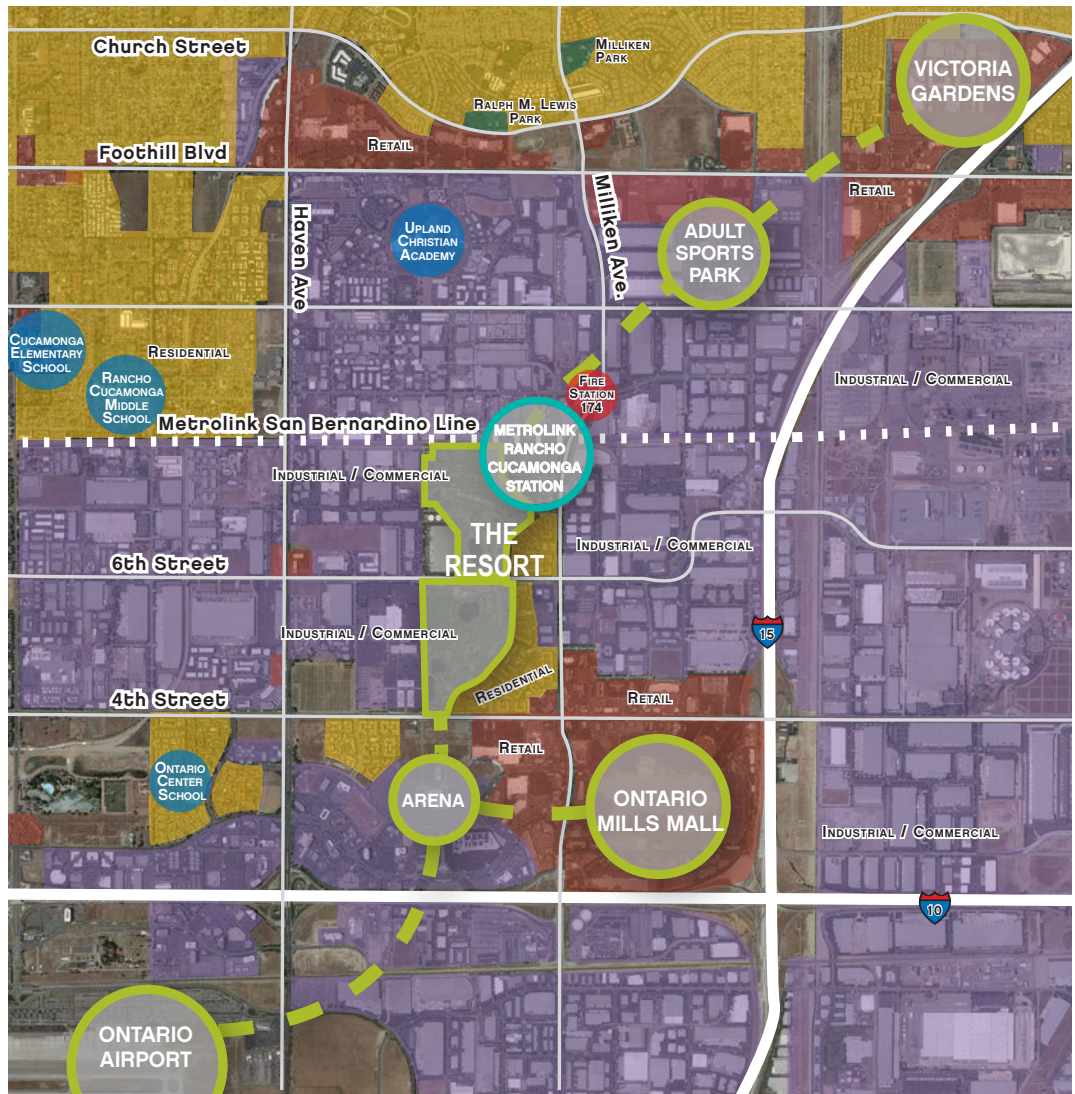

Figure 8.4: Regional Activity Context

Note: Figure not to scale.



Connect the community visually and physically with pedestrian pathways that lead to a variety of services and destinations.

A well-connected community encourages residents to use multiple modes of transportation in the course of their daily activities, promotes easy access to the Metrolink station for increased transit usage, and leads to a reduction in the number and length of vehicle trips - minimizing greenhouse gas impacts and conserving energy.

The Vine, the multi-modal backbone of the community, is designed to provide the backbone of multi-modal connectivity from 4th Street to 6th Street, connecting all neighborhoods in-between.

The entire community is located within one mile of the Metrolink station. The Ion, the existing 6th Street underpass, enables a north/south connection for pedestrians that ties into the Vine, reducing reliance on automobiles as a primary means of travel throughout the community. The circulation framework reinforces the goal of creating a pedestrian friendly environment. This focus on pedestrian circulation is supported by 3rd Place spaces including Grand Paseos, gathering spaces, and pathways.

3rd Places are designed to encourage a dynamic living environment with integrated open spaces that link people with jobs and community activities with the surrounding venues. Figure 8.3: Design Concept identifies conceptual pedestrian-oriented design features.



3rd Place Spaces



3rd Place spaces are transitional social spaces that link people, neighborhoods, and lifestyles. A 3rd Place isn't a singular place or large venue, but rather a collection of smaller more intimate spaces designed to be unique and quirky and encourage people-gathering. Beyond work, school, and home, these 3rd Place spaces are memorable and unique spaces that people adopt and craft into something remarkable and define the character of the surrounding neighborhood. As part of the healthy, active community goals, a network of 3rd Place spaces will be integrated within and between neighborhoods to foster a dynamic setting for active and social living.



Examples of sustainable landscape

Configure a community that is built on the fundamentals of smart growth and environmental responsibility.

Sustainability is an integral design feature related to urban infill development adjacent to a transit station. The adjacency of higher density residential uses, retail services, and additional job opportunities, near transit facilities reduces vehicle miles traveled (VMTs) and is a central feature of the Sustainable Communities requirements. All homes will be within a 20-minute walk of the Metrolink station via the Vine, connecting streets and 3rd Place network. Storm water quality best management practices (BMPs) will capture the targeted high frequency, low flow storm water through infiltration, and recharge the below ground aquifers. The landscape design will utilize Southern California appropriate vegetation reducing water use (a valuable resource) and the energy use required for pumping and distributing irrigation water. Climate appropriate plant materials and non-invasive ornamental landscape materials will be utilized as the primary plant materials.

Other sustainable features include:

- Minimizing the amount of paved area of roadways, sidewalks, driveways, and parking areas to the extent feasible.
- Breaking up of large areas of impervious surface areas and directing stormwater flows away from these areas.
- Providing runoff storage dispersed though the site through bioretention facilities and landscape buffer areas.
- Limiting turf grass to active use areas only.
- Using pervious surfaces within landscaped areas where feasible.
- Providing shade opportunities in public areas such as parkways, medians, and public parks for naturally cool public spaces.
- Using reclaimed water to irrigate public parks, neighborhood edges, and other common landscape areas.
- Reducing energy demands for heating and cooling using the latest Title 24 requirements and incorporating green building design practices wherever feasible.



Implement the goals of Healthy RC through design and space programming.

A key component for a successful community will be the blending of the fundamental components of the Healthy Rancho Cucamonga, Healthy RC program. Lifestyle programming will be developed that improves urban patterns that support healthy environments. A “Full Cycle” approach of zoning and soft programming will help shape development. Elements of connected neighborhoods, exercise, arts and culture, education, food, and entertainment will be thoughtfully incorporated into 3rd Place spaces and adjacent to the Vine, going beyond a singular dimensional community. Residents will have multiple levels of experiences at the individual and the community level.

The Vine provides an organizational and experiential link for the entire community. Along this corridor will be a series of 3rd Place spaces providing major and minor activity zones. Each 3rd Place will be an individual social space that may be a Grand Paseo, bark park, pocket park, or pathway that progressively builds on each other with complementary uses, experiences, and enables pedestrian mobility. These social spaces will incorporate active uses such as walking, running, play features, and biking to promote an outdoor lifestyle and healthy activities.

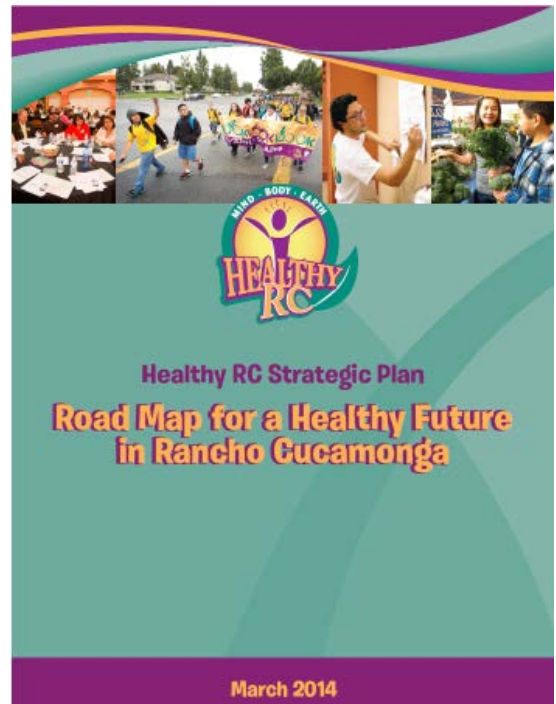

Healthy RC Strategic Plan



8.2.2 Community Framework

A. The Vine

As described earlier, the Vine is the backbone for multi-modal circulation. This serves as the spine road and major vehicular connector. This pedestrian-scaled roadway includes vehicular lanes, bike lanes with buffer striping, on-street parking, and a generous 16-foot pedestrian realm on each side for pedestrian activity; all features that promote an enjoyable circulation experience through the community. The pedestrian realm is designed for pedestrian engagement, incorporating street trees, seating, plazas, activity spaces, and connections to neighborhood pathways and 3rd Place spaces. The combination of these features effectively serve vehicular, bicycle, and pedestrian traffic, minimizing conflicts with a continuous north/south multi-modal spine.

The Vine is the central pedestrian and activity spine, providing social stopping points and urban activity venues at intervals through the mixed use village. Design features will incorporate climate-appropriate landscape and hardscape elements that provide shade, a cooling effect, and unique gathering spaces. This robust pedestrian realm is layered with connective 3rd Place spaces that will meld each neighborhood to the Vine and to each other. Pathways and 3rd Place Spaces within the mixed use parcels will connect neighborhoods to the Vine, providing a high level of pedestrian access throughout. See Figure 8.5: Conceptual Vine for more details.

Pedestrian Realm

The pedestrian realm extends from the curb edge to the building frontage. This pedestrian-dominated space is an integral part of the streetscape, necessary to balance the use of the streets for vehicle movement and pedestrian access. Amenities that contribute to a comfortable and inviting pedestrian realm may include hardscape, planting, seating, dining or patio areas, and bicycle parking. A quality pedestrian realm will connect the different functions and public spaces of the community and invite people to walk, cycle, and use public transit.

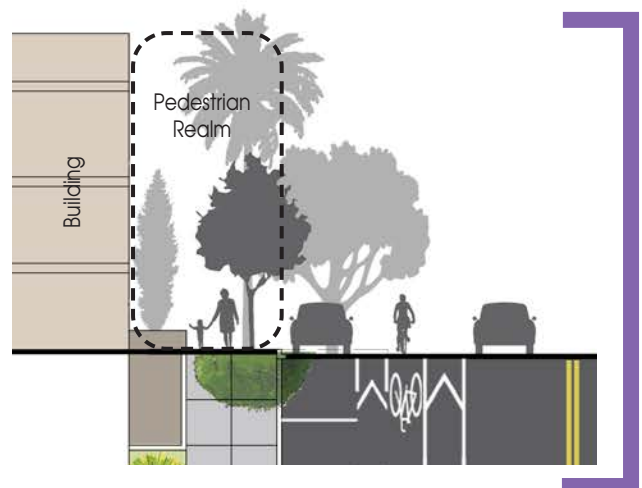

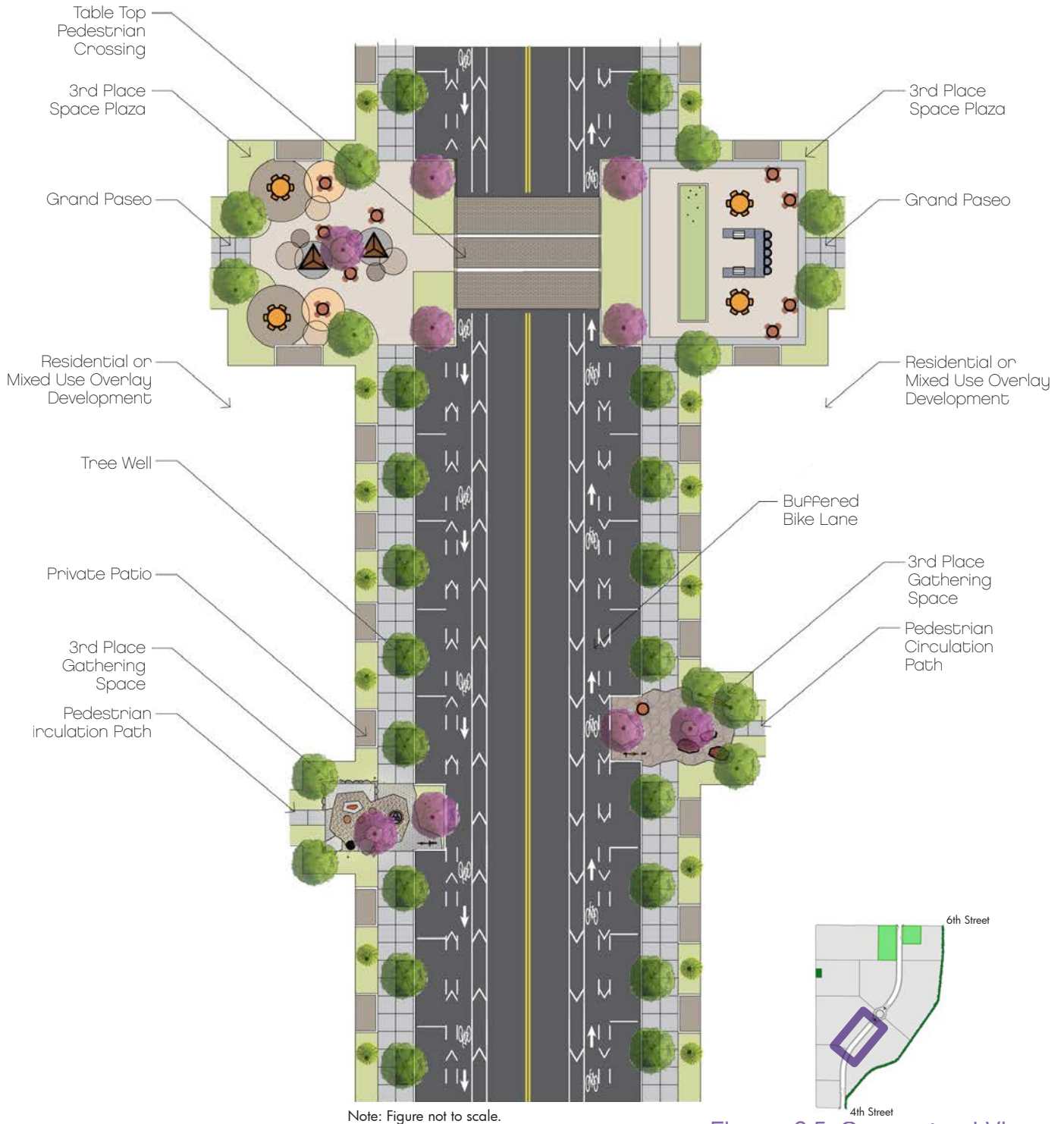

Figure 8.5: Conceptual Vine



Design of streets and pathways plus building massing will create active and intimate urban spaces.

The following design features reinforce a cohesive pedestrian-friendly environment:

- A connection from 4th Street to the Metrolink station.
- Seamless pedestrian connections via the Ion (the 6th Street underpass) without crossing a major arterial.
- Local streets designed to serve vehicular and pedestrian circulation equally with narrower or compact design solutions suitable for a pedestrian-friendly environment.
- Streets designed to balance pedestrian, bicycle, and vehicular mobility to link neighborhoods to each other, recreational amenities, and mixed use destinations.

Traffic calming elements integrated into the design of the circulation system include:

- A bent grid street system for simple, direct, and understandable circulation.
- Tapered streets that narrow street widths at intersections to provide for shorter and safer pedestrian crossings and encourage drivers to slow down. See Figure 8.28: Table Top Pedestrian Crossing/Tapered Street for a taper example.
- Use of roundabouts along the Vine to slow traffic and incorporate community design features.
- Provision of on-street parking wherever feasible.
- Use of Table Top pedestrian crossings, subject to City approval, for convenient and visible pedestrian circulation.

Table Top Pedestrian Crossing

A Table Top Pedestrian Crossing is a traffic calming device that raises the entire wheelbase of a vehicle to reduce its traffic speed and increase the aesthetic and safety of the pedestrian crossing. It includes a flat section in the middle with ramps leading up-to and down-from the pedestrian crossing; sometimes it is constructed with textured materials or color designs on the flat section. Vehicle operating speeds for streets with Table Top crossings are higher than standard speed humps and range from 25–45 mph, depending on the spacing. See Section 8.3.6.D. Pedestrian Circulation for more details.

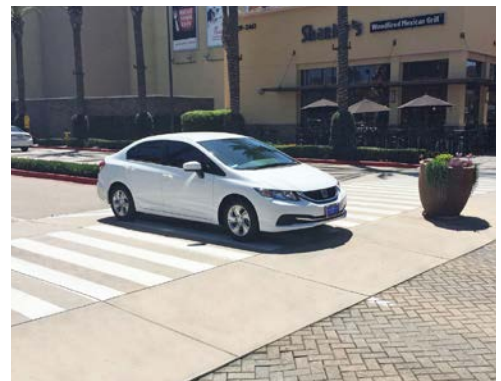

B. The Ion

Pedestrian-activity is largely based on how effectively destinations are connected. The Ion (the existing 6th Street underpass) will enable seamless pedestrian connectivity along the length of the village, eliminating the need to cross a major arterial from 4th Street to the Metrolink station. The Ion underpass is an aesthetically redesigned feature incorporating light-based design features to enhance the experience with accessible entrances north and south of 6th Street. Recreation amenities will be located in conjunction with the Vine on each side of the Ion enhancing the pedestrian experience. The visual light-based design of the Ion makes this a destination and photo opportunity highlight of the community. See Figure 8.25: Conceptual Ion Sections and Figure 8.26: Conceptual Ion Plan for more details.



Conceptual rendering of the lighting design for the Ion underpass

C. 3rd Place Spaces

3rd Place spaces form a connective network of pedestrian amenities that tie neighborhoods together by creating unique spaces throughout the community. 3rd Places include three types of unique connective spaces:

- Grand Paseos
- Pathways
- Gathering spaces

There will be four east/west Grand Paseos linking existing adjacent open space areas to the Vine; these may be enhanced by a bark park, gathering places, and Table Top pedestrian crossings. See Section 8.5.1.C. 3rd Place Spaces for more details.



Inspirational imagery for creating memorable 3rd Place spaces



Example of articulated massing



Example of a mixed use building type and integrated 3rd Place spaces

D. Mixed use Architecture and Site Planning

A contemporary architectural vocabulary with adaptations of traditional vernaculars will be combined with comprehensive site planning to produce a mixed use village that provides a strong sense of place for residents. The following design elements achieve this:

- A broad architectural vocabulary focused on massing, articulation, and the creation of dynamic indoor and outdoor living environments.
- A composition of varied building types, forms, and intensities that create a visually interesting and dynamic place.
- Building patterns that create distinct open spaces for social interaction within each neighborhood.
- A framework of pathways and 3rd Place Spaces inviting to the pedestrian experience.
- Site planning that located large parking fields behind the pedestrian realm.
- Opportunities for horizontal and vertical mixed use areas.
- Site planning that allows for integrated living, working, recreation, and commercial areas.

8.3 Urban Design Standards

The conceptual development plan strategically locates a range of Placetypes. This approach encourages variety within the built environment by addressing the relationship of the built form to people places rather than the strict relationship of uses to each other.

Figure 8.6: Conceptual Development Plan by Placetype achieves the following:

- A human scale of development oriented to pedestrian activities with connectivity provided through the network of the Vine and 3rd Place spaces.
- Provision of a broad range of densities with attached and detached homes addressing a variety of lifestyle and economic segments.
- An integrated Recreation (REC) Placetype in close proximity to neighborhoods and the Vine.
- Residential neighborhoods designed with multi-modal connections to transit.
- Opportunities for integration of non-residential and service elements within neighborhoods under the Mixed Use (MU) Placetype and the Mixed Use Overlay.



8.3.1 Development Potential

The minimum and maximum amount of development permitted within PAIA is specified in Table 8.1: PAIA Development Program. The development program includes minimum and maximum thresholds to facilitate an urban community within the constraints of the vehicular environment.

A. Maximum Development

A “Maximum Permitted” unit count and non-residential square footage have been established by Table 8.1: PAIA Development Program. The “Minimum Required” unit count guarantees a higher-density development, while the maximum permitted unit count manages that density within appropriate thresholds based on traffic study constraints.

The “Non-Residential Maximum Square Footage” identified in Table 8.1: PAIA Development Program shall be considered the maximum allowed within PAIA; this potential square footage may be developed within either The Mixed Use Placetypes or under the Mixed Use Overlay.

Note: Development occurring within PAIA is in addition to the maximum development potential established by Table 1-1, Summary Land Use Development Program on page 1-5 of this Specific Plan. For Placetype descriptions see Section 8.3.4 Development Standards; See Section 8.3.3 Land Use for permitted uses.

B. Mixed Use Development

The Specific Plan provides for a more urban development pattern with a mix of higher density residential and non-residential in a pedestrian-friendly setting that has great access to transit. The Planning Area is intended to provide a unique and engaging experience that offers convenient access to activities, public spaces and services. Planning Areas 1A and 1B will have up to 3,450 residences and 220,000-square-feet of non-residential uses will be located within 0.5 mile of the Metrolink station. The residential development will be characterized by a combination of attached and detached medium to high density homes. Within the Mixed Use Placetype and under the MU Overlay, development may occur as single-use or mixed-use consistent with Table 17.38.070-1: Allowed Land Uses and Permit Requirements by Placetype.

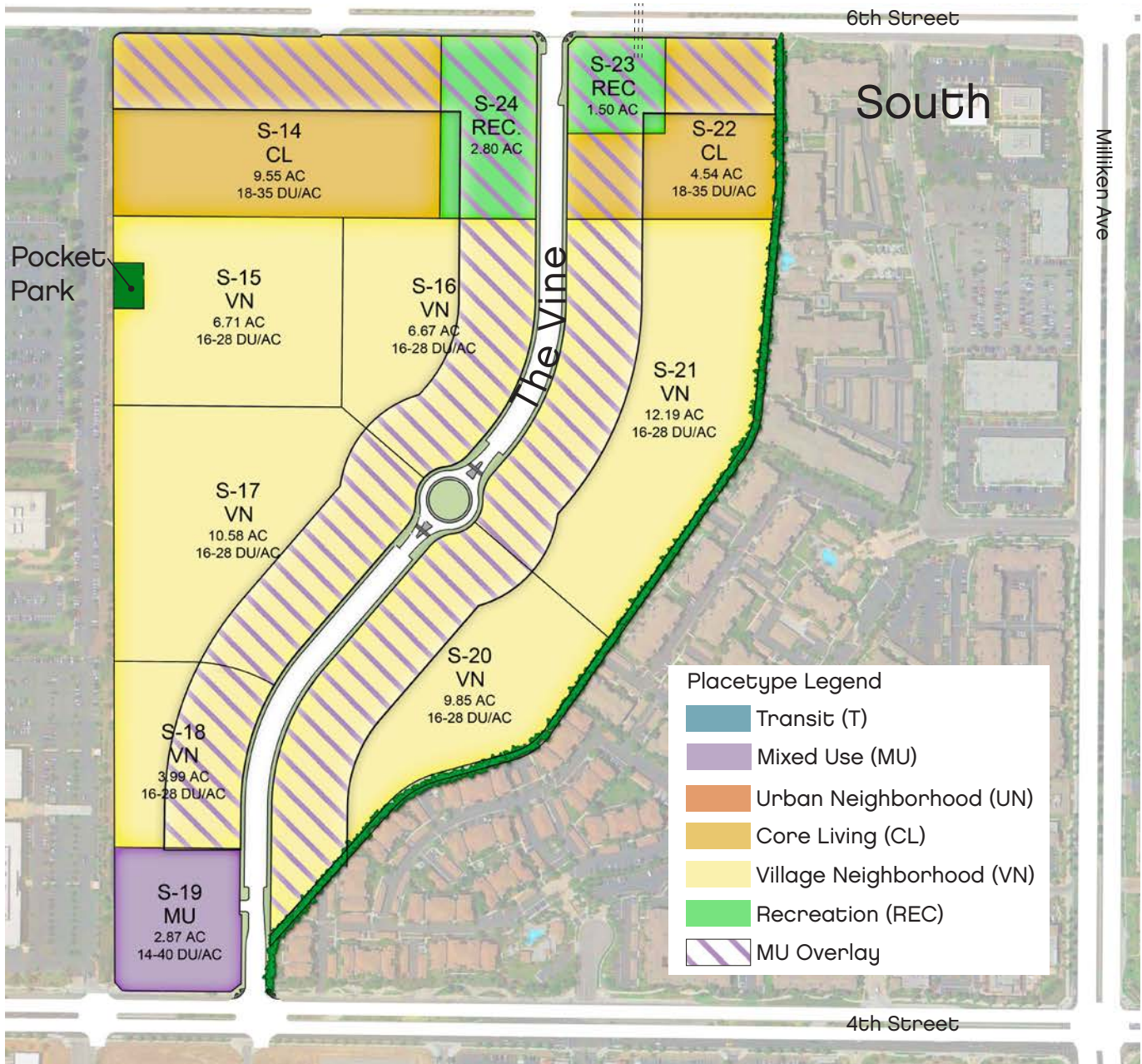

Figure 8.6: Conceptual Development Plan by Placetype



Table 8.1: PAIA Development Program

South of 6th Street					
Placetypes	Acres ⁽¹⁾	Non-Residential Max SF	Residential		
			Permitted Density Range ⁽²⁾	Minimum Permitted Units ⁽²⁾	Maximum Permitted Units ⁽²⁾
Mixed Use (MU)	2.9	35,000	14-40	0	115
Core Living (CL)	14.1	-	18-35	254	493
Village Neighborhood (VN)	50.0	-	16-28	800	1,400
Potential Subtotal	67.0	35,000	15.7 - 30.0	1,053	2,008
Net Developable Minimum Required ⁽¹⁾ / Maximum Permitted	67.0	35,000	15.8 - 21.7	1,056	1,450
Non-Developable					
Recreation (REC)	4.3	(4)	-	-	-
Roads/Misc. OS	7.1	-	-	-	-
Non-Developable Subtotal	11.4	(4)	-	-	-
Gross Developable Minimum Required ⁽¹⁾ / Maximum Permitted	78.4	35,000	13.5 - 18.5	1,056	1,450
PAIA Total Mixed-Use Overlay					
Placetypes	Acres ⁽¹⁾	Non-Residential Max SF	Residential		
			Permitted Density Range ⁽²⁾	Minimum Permitted Units ⁽²⁾	Maximum Permitted Units ⁽²⁾
Minimum Required SF South of 6th Street	-	20,000 ⁽⁵⁾	Consistent with underlying Placetype		

Table notes:

(1) Exact acreage, configuration, and boundary lines subject to final design. Minimum required units regulated by target units on a per parcel basis. See 8.7 Implementation for parcel target units, tracking, and density transfers.

(2) Development of each parcel may occur at any density within the established range; however, in no case shall the total number of dwelling units developed exceed the Gross PAIA and PA1B Total of 3,450 dwelling units.

(3) Development SF in the T Placetype was not included in the EIR analysis because it is adjacent to a Transit Station and provides Transit supportive uses. Therefore the 220,000 SF maximum for Section and 9 (PA1A and PA1B) is equivalent to the 195,000 SF in the EIR.

(4) Development square footage within the REC Placetype is for private use by residents of PAIA and PA1B, not contributing to trip generation of the site, and is therefore not subject to the square footage maximum established by this table or the applicable EIR traffic study. Any non-residential use developed for public access within the REC Placetype shall be subject to the 220,000 SF maximum. The City of Rancho Cucamonga may include up to 25,000 SF and up to 1.75 acres of Planning Area N-13 for Municipal Joint Use Facilities.

(5) A minimum of 50,000 SF of non-residential development in the Overlay is required; if only 20,000 SF is developed south of 6th Street, 30,000 SF of non-residential use is required north of 6th.

General Note: Aggregate of all PAI non-residential development, (excluding recreation area development within the REC Placetype), shall not exceed the 220,000 SF maximum.

8.3.2 Placetype Descriptions

Six Placetype designations have been established to create a vibrant built environment that integrates residential and services in a mixed use community. The Placetype designations are:

- Transit.
- Mixed Use.
- Urban Neighborhood.
- Core Living.
- Village Neighborhood.
- Recreation.

All Placetypes may be developed as for-sale or for-rent neighborhoods. Within each Placetype, Grand Paseos and/or connecting pathway 3rd Place spaces promote pedestrian circulation.

A Mixed Use Overlay designation, see Figure 8.6: Conceptual Development Plan by Placetype, allows for flexible development at key locations. The Mixed Use Overlay represents possible locations for commercial or horizontal/vertical mixed use developments based on market conditions. Mixed use development can include combination of residential and non-residential uses, as well as the combination of different residential densities within a single development. In no case shall the development of non-residential square footage exceed the maximum established by Table 8.1: PAIA Development Program.

To maintain flexibility for responding to changing community needs and market conditions over the build-out, intensity may be transferred between parcels consistent with the Placetype intensity, provided the minimum required units are achieved. Where density transfers between parcels, in no case shall development exceed the net development total (residential and non-residential) established by Table 8.1: PAIA Development Program. See Table 17.38.070-1: Allowed Land Uses and Permit Requirements by Placetype for permitted land uses by placetype.





Source: Designlens.com



A. Transit (T) Placetype

Density: Residential not permitted

Permitted Square Footage: 25,000 SF

Primary Land Use: Transit-oriented services





PAGE INTENTIONALLY LEFT BLANK

B. Mixed Use (MU) Placetype

Density: 14-55 DU/acre (based on specific parcel density)

Permitted Square Footage: 110,000 SF (PA1A & 1B)

(S-19: 35,000 SF)

Primary Land Use: Mixed Medium-High Density Residential and Non-Residential Uses

The MU Placetype is intended to contribute to the employment/housing balance and reduce the carbon footprint of the community by allowing the location of jobs and services in close proximity to transit and high-density residential. This Placetype promotes horizontal and vertical mixed use configurations that form an active setting along the Vine and the pedestrian access to the Metrolink station. A range of blended land uses may provide community-oriented retail, business services, child care, and housing. Buildings are encouraged to provide active, articulated facades close to the minimum setback line along the Vine.



Live/work, retail, and horizontal mixed use setting inspirational images



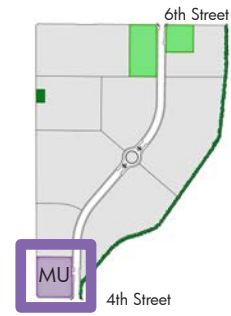

Note: Plotting may vary; figure not to scale.

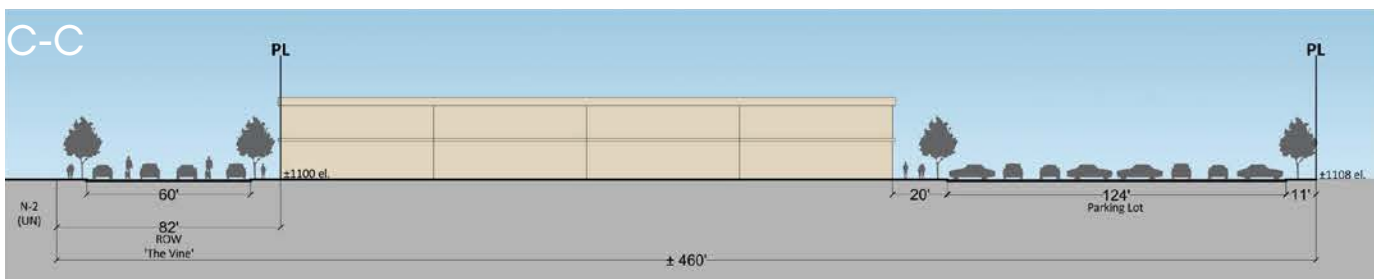

Note: Figure not to scale.

Figure 8.8: Conceptual Mixed Use Placetype Plan & Section

C. Urban Neighborhood (UN) Placetype

Density: 24-80 DU/acre

Primary Land Use: High-Density Residential

The UN Placetype does not occur in PA1A





PAGE INTENTIONALLY LEFT BLANK

D. Core Living (CL) Placetype

Density: 18-35 DU/acre

Primary Land Use: Medium-High Density Residential

The CL Placetype is a residential designation that may include a broad range of attached and/or small lot detached neighborhoods. Parcels designated as CL should have pedestrian pathways within neighborhoods, and connections to community destinations. Building forms should include architecturally appropriate massing with elevations facing the street, 3rd Place spaces, and the Vine as applicable.

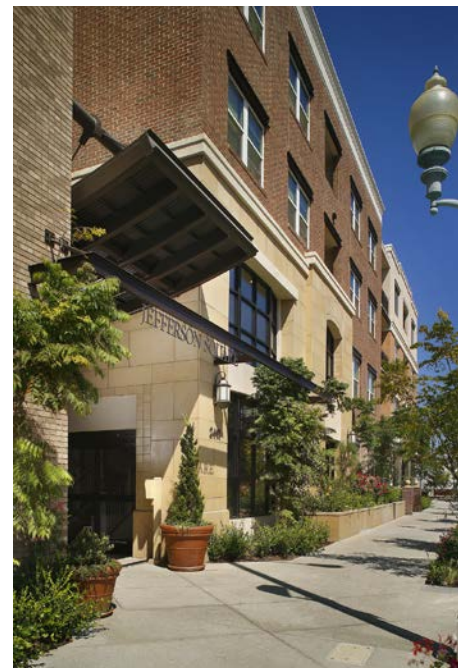

High-density inspirational images



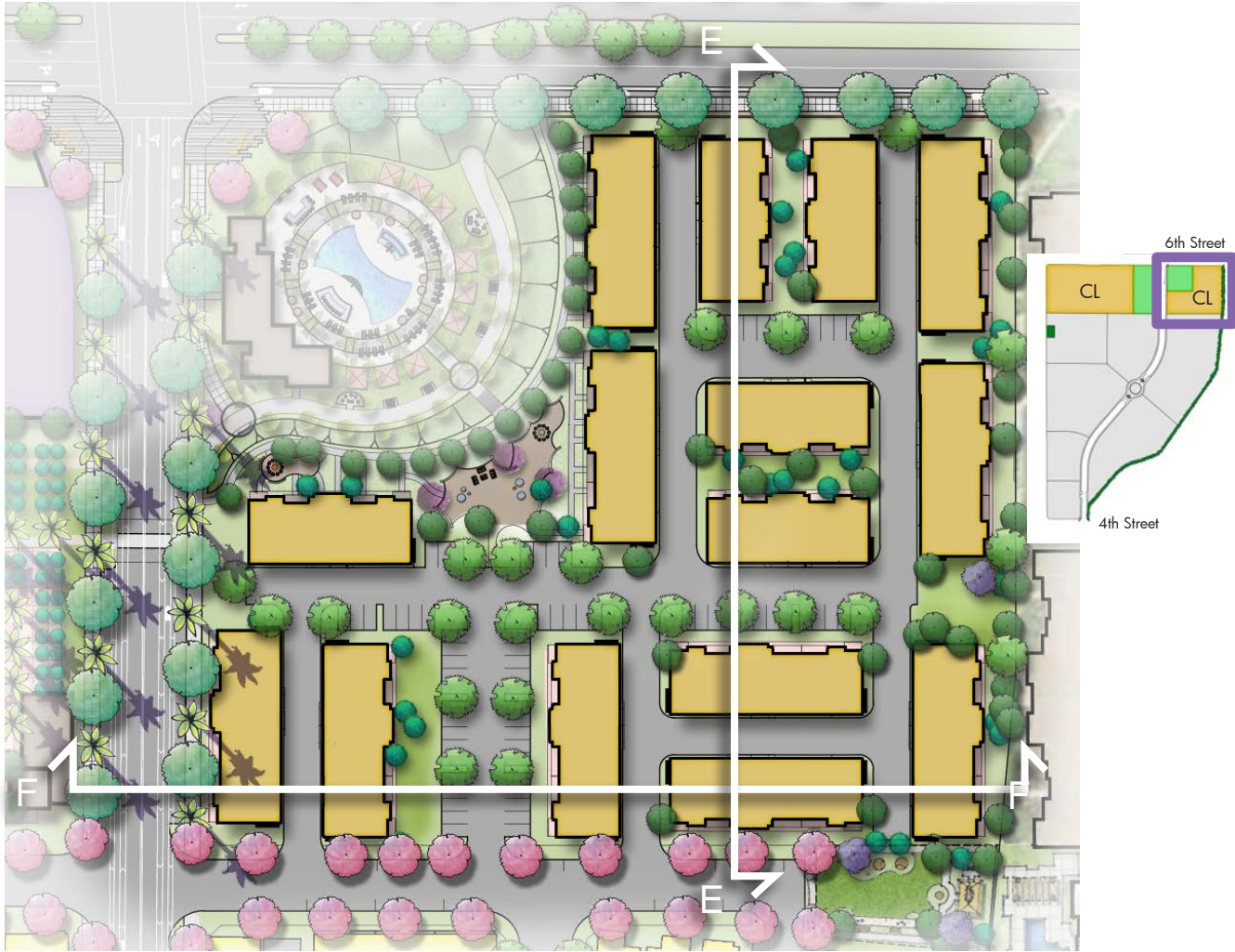

Note: Plotting may vary; figure not to scale.

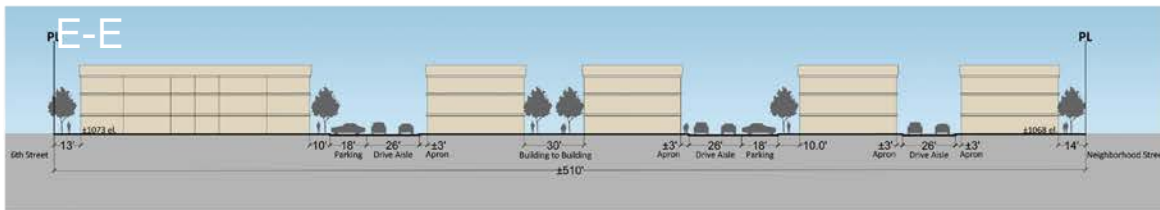

Note: Figure not to scale.



Note: Figure not to scale.

Figure 8.10: Conceptual Core Living Placetype Plan & Sections

E. Village Neighborhood (VN) Placetype

Density: 16-28 DU/acre

Primary Land Use: Medium Density Residential

The VN Placetype is residentially focused and intended for various forms of detached and attached configurations. Housing types could range from small lot detached single-family to attached configurations. Layout, design, block length, and parking should be suitable for this setting with elevations facing the street, 3rd Place spaces, and the Vine as applicable. Homes should be designed with private open space, and neighborhoods planned with 3rd Place transitional spaces connecting to adjacent neighborhoods.



Attached and detached medium density inspirational images



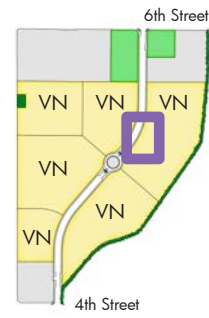

Note: Plotting may vary; figure not to scale.



Note: Figure not to scale.

Figure 8.11: Conceptual Village Neighborhood Placetype Plan & Section

F. Recreation (REC) Placetype

Density: Residential not permitted

Primary Land Use: Common Private & Public Recreation Amenities (PA1A & 1B)

The REC Placetype is featured at five central parcels to provide a variety of resident-friendly elements that will build a vibrant community dynamic. The REC areas are sited for prime exposure, access to surrounding neighborhoods, and potential for retail components under the Mixed Use Overlay. The clubhouse and recreational facilities will act as a “center” for the community and exhibit a high level of quality design and attention to detail.

The community REC areas may include the following types of amenities:

- Plaza space that ties into the Urban Plaza and on pedestrian connection.
- Fitness area.
- Pool and spa.
- Community meeting rooms.
- Management offices.
- Non-residential services and retail.
- Public and Joint Use Facilities for Public Safety, Community Services, and Library Services.



Recreation inspirational images





PAGE INTENTIONALLY LEFT BLANK

G. Mixed Use Overlay

The Mixed Use Overlay, as identified in Figure 8.6: Conceptual Development Plan by Placetype, may be applied voluntarily to a parcel, or portion of a parcel. The Mixed Use Overlay provides market flexibility and added placemaking opportunities.

The Overlay allows a combination of residential and non-residential horizontal or vertical mixed use along the prime vehicular and pedestrian connections to add commercial and service elements. Where the Mixed Use Overlay is exercised, the non-residential uses should be carefully designed to provide an engaging interface.

Development occurring under the Mixed Use Overlay is subject to the standards and guidelines of the MU Placetype; all non-residential square footage shall count toward the total gross square footage allowed in Table 8.1: PAIA Development Program.

Table 8.2: MU Overlay Standards

Standard	
Applicable Parcels	S-14, S-16, S-17, S-18, S-20, S-21, S-22, S-23, S-24
Applicable Location	Allowed within 200 feet measured from applicable ROW: the Vine, 6th Street and 7th Street
Maximum Development	Residential: Consistent with underlying Placetype; Non-Residential: Not to exceed 85,000 SF



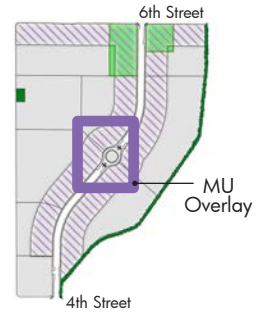
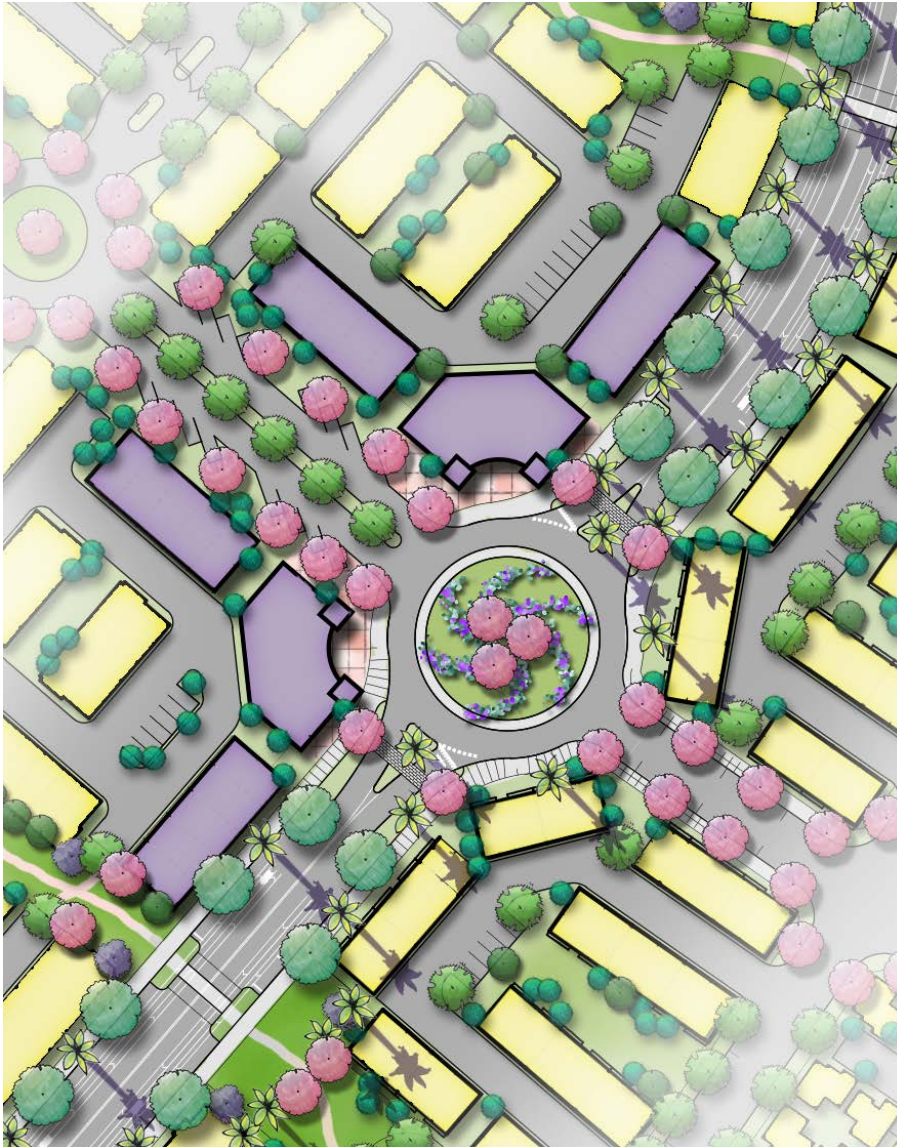

Note: Plotting may vary; figure not to scale.

Figure 8.13: Conceptual Mixed Use Overlay Placetype Plan

8.3.3 Land Use

Section 17.38.070 of the City’s Development Code regulates the land use for PAIA. Land Use “Table 17.38.070-1: Allowed Land Uses and Permit Requirements by Placetype” identifies the allowed land uses and permit requirements by Placetype. Land use permission for each Placetype have generally been aligned with the City of Rancho Cucamonga zoning districts for ease of implementation.

Land use classifications/categories, descriptions, and entitlement/permit requirements are per the City’s Development Code.

For more information please refer to Appendix E Zoning Code Amendment.

8.3.4 Development Standards

Table 8.3: Development Standards establishes the development standards by Placetype. Table 8.5: Perimeter Setbacks establishes minimum setbacks from the PAIA boundary property line and key edge conditions.

PAIA development standards are intended to facilitate creative architectural design through minimal internal regulations, thus allowing the boundaries of building configurations to be set by the adopted building code. This will allow for flexibility of building patterns, progressive development of new product types and configurations that meet the intent of the Specific Plan, and the greatest adaptability to market changes.

The correlation between parcel location, Placetype, and building configuration should consider the three dimensional nature of the entire development, including height, massing, siting, and orientation. These characteristics must relate to the surrounding built form, respecting the overall neighborhood character.

Site plans and building design are encouraged to locate buildings and entries at or close to the minimum setback line, as feasible.

All setbacks established by this section are minimum requirements subject to encroachments permitted by Table 8.4: Permitted Encroachments; see 8.4.1 Site Planning Criteria for additional information.

How to Use These Development Standards

Each development project should focus on the relationship between the built form and the public environment, with emphasis on building siting and orientation, height and massing, articulation of facades and entry ways, building fenestration, pedestrian circulation, type and placement of street trees, landscaping and transitional spaces, and location of driveways and garages.

These development standards should be used in conjunction with the architecture design guidelines in Section 8.4 Architectural Guidelines and landscape design guidelines in Section 8.5 Landscape Design.



Development standards are designed to maximize creativity and flexibility in design to create active people places.



Table 8.3: Development Standards

Standard/Zoning District	VN	CL	UN*	T*	MU	MU Overlay
Lot area (minimum/minimum net avg)				No minimum		
Lot width (minimum/corner lot)				No minimum		
Lot depth (minimum)				No minimum		
Minimum frontage (standard or flag lot)				No minimum		
Allowed Density (dwelling units per acre)						
Minimum density ⁽¹⁾	16 du/ac	18 du/ac	24 du/ac	Residential prohibited	By parcel : N-10: 14 du/ac N-13: 14 du/ac N-18: 35 du/ac S-19: 14 du/ac	Consistent with underlying Placetype. See v: Conceptual Development Plan by Placetype
Maximum density	28 du/ac	35 du/ac	80 du/ac		N-10: 40 du/ac N-13: 40 du/ac N-19: 55 du/ac S-19: 55 du/ac	
Lot Coverage (maximum lot coverage with buildings as a percentage of the Parcel or project)						
Lot Coverage				No maximum		
Allowed Floor Area Ratio (FAR)						
Maximum FAR				No maximum		
Minimum Building Setbacks from Property Lines⁽²⁾						
From PAIA Boundary PL	Based on Edge Condition; See Table 8.5: Perimeter Setbacks					
Front Yard/Rear Yard	0 ft					
From Vine ROW ⁽³⁾ - PA1A	5 ft	5 ft	5 ft	—	5 ft	5 ft
From Secondary Entry ROW ⁽³⁾	See Table 8.5: Perimeter Setbacks					
From 4th Street & 6th Street ROW ⁽³⁾	See Table 8.5: Perimeter Setbacks					
From Collector Road ROW	See Table 8.5: Perimeter Setbacks					
From Private Drive Aisle/Alley	0 ft	0 ft	0 ft	0 ft	0 ft	0 ft
Corner side yard (interior to a Parcel)	5 ft					
Interior side yard	0 ft; Consistent with adopted CRC or CBC					
At interior parcel boundary (dwelling/accessory building)	5 ft					
Walls and Fences	Consistent with Table 17.48.0505-1 Free-standing retaining walls shall be set back a minimum of 2 feet from back of sidewalk. Retaining walls shall not abut a sidewalk, but may abut utility boxes.					
Building Height						
Primary buildings (maximum height in feet)	South of 6th Street: 60 ft Occupiable roof tops, PV systems, and all other roof top features shall be consistent with adopted CRC or CBC and ALUCP requirements. Any structure developed adjacent to the existing residential uses along the eastern perimeter of PAIA shall be limited to 45' in height within 20 feet of the PAIA boundary line. See "Figure 8.18B: Residential Edge Section".					
Fences and Walls	Consistent with Table 17.48.0505-1 or as required by acoustical reports					

Table 8.3: Continued

Standard/Zoning District	VN	CL	UN*	T*	MU	MU Overlay
Open Space Requirement (minimum percentage of open space per parcel or project)						
Combination of Private and Common open space (ground floor/upper story)	150 sf per unit combined; May be provided in private, common, or a combination of these spaces.			See Section 8.3.4.C. Private/Public Open Space for additional standards.		
Minimum patio/porch depth, where provided				5 ft ⁽⁴⁾		
Recreation	Individual projects are exempt from Recreation Area/Facility requirements of 17.36.01(E) of the City's Development Code since common recreation facilities are provided within the community.					
Minimum Dwelling Unit Size ⁽⁵⁾						
Single-family (attached and detached)	450 sf; excludes required parking and open space					
Multi-family	450 sf; excludes required parking and open space					
Efficiency/studio	450 sf; excludes required parking and open space					
One bedroom	450 sf; excludes required parking and open space					
Two bedrooms	450 sf; excludes required parking and open space					
Three or more bedrooms	450 sf; excludes required parking and open space					
Distance Between Building/Structure (minimum)⁽⁶⁾						
① Between buildings with no patio or balcony	Consistent with adopted CRC or CBC by occupancy type					
② Between patio fence/wall	5 ft					
③ Between balconies	Consistent with adopted CRC or CBC by occupancy type					
④ Between a patio fence/wall and a building wall	5 ft					
With common patio fence/wall	0 ft; except at PAIA boundary, shall be consistent with edge condition. See Table 8.5: Perimeter Setbacks					
Building separation across a Private Drive Aisle	26 ft clear ⁽⁴⁾					
Other Miscellaneous Building Setback Requirements (minimum)						
Building to detached garage/ carport or other accessory structure	Consistent with adopted CRC or CBC					
Building to wall or curb at project entry	5 ft					

Notes:

- (1) Excluding land necessary for collector streets and arterials.
- (2) Setbacks applies to any "front" or "side" elevation as measured from the face of structure to back of right-of-way (ROW) or specified property line unless modified by Table 8.4: Permitted Encroachments. See Figure 8.15 Minimum Building Setbacks and Table 8.5: Perimeter Setbacks for additional definition of building setbacks. See Table 8.6: Parking Standards for parking setbacks.
- (3) See Figure 8.17: Setback Locations for a graphic location of this setback condition.
- (4) Free and clear of vertical and horizontal obstructions.
- (5) Senior/Age-Qualified projects are exempt from this requirement.
- (6) See Figure 8.14 Distance Between Building/Structure below.

* Does not apply to PAIA



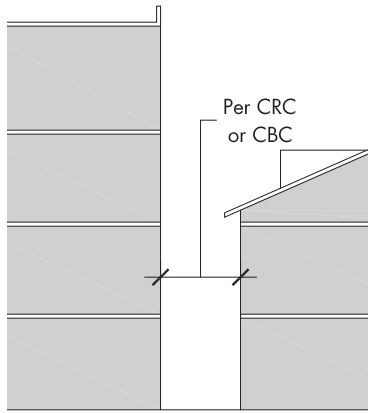

1 Between Buildings
No Patio or Balcony

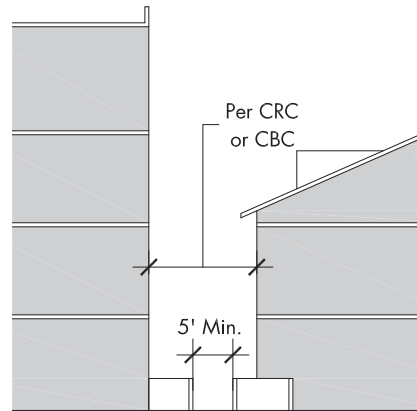

2 Between Patio Fence/Wall

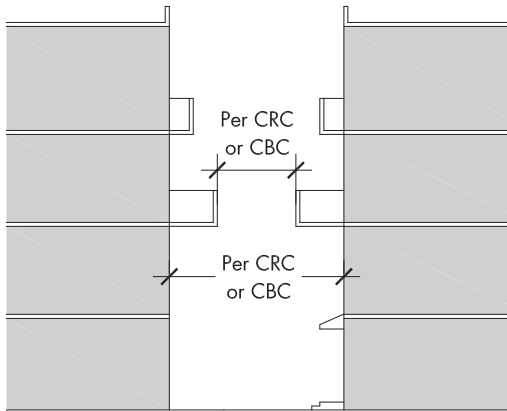

3 Between Balconies

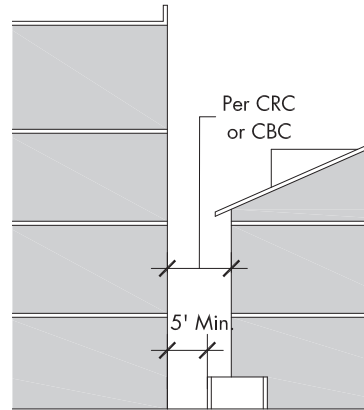

4 Between Patio Fence/Wall
and Building Wall

Note: Figures not to scale.

Figure 8.14 Distance Between Building/Structure

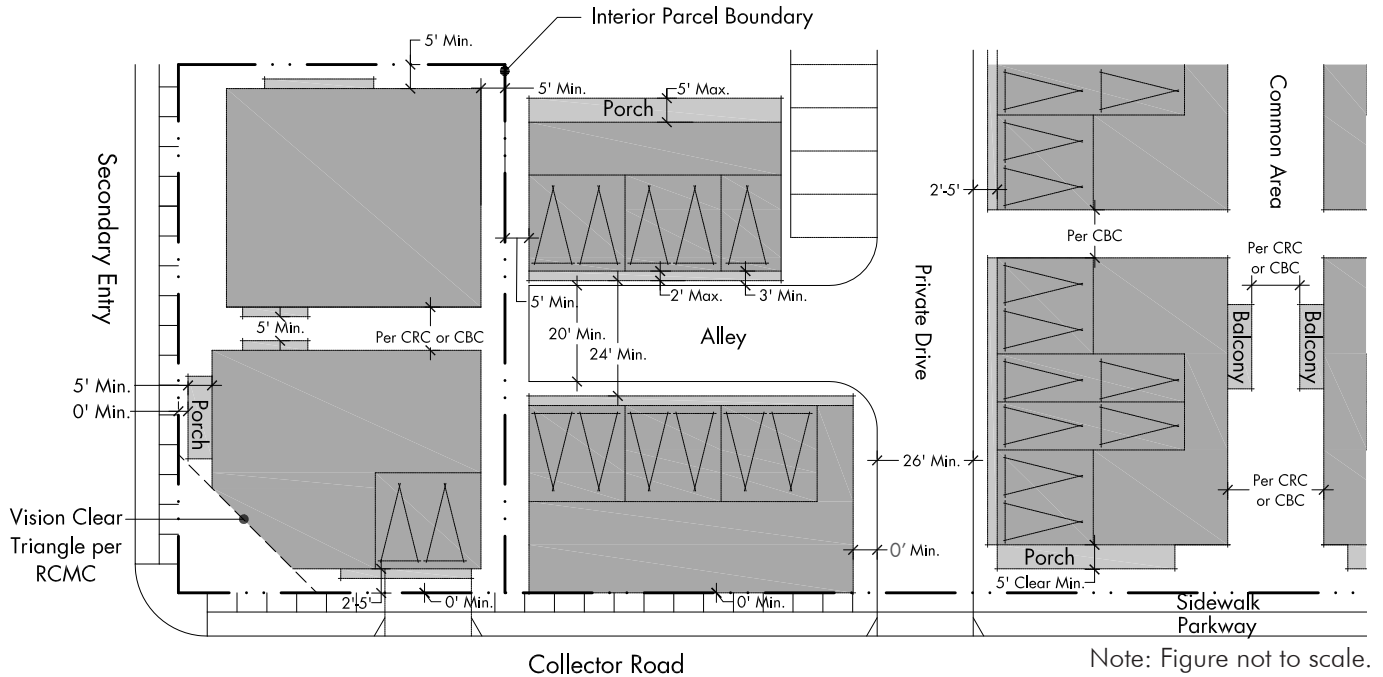

Figure 8.15 Minimum Building Setbacks

A. Setback Encroachments

An encroachment is a permitted projection into a setback. These encroachments permit architectural variation on facades, provide for private and common open space, accommodate parking, and further activate the pedestrian realm.

All permitted encroachments are described on Table 8.4: Permitted Encroachments and depicted in Figure 8.16: Encroachment Diagrams. In all cases, encroachments shall comply with the current editions of the California building codes.

Table 8.4: Permitted Encroachments

Standard	Permitted Encroachments into Required Setback	
	Adjacent to ROW	Adjacent to PAIA Boundary Line
1 Ground floor private or common open space	3 feet	3 feet
2 Fireplaces, bay windows, cornice, eaves, sills, & similar architectural features	3 feet or per the California Building Code, whichever is less stringent	
3 Upper floor private or common open spaces & balconies (8-foot minimum vertical clearance required, measured from the floor below)	5 feet	5 feet
4 Awnings, lighting fixtures, and canopies (8-foot minimum vertical clearance required measured from the floor below)	4 feet	3 feet
5 Subterranean garages; 2-foot buffer required above for proper landscape growth	5 feet	5 feet
Porte cochere, transformers, similar features	5 feet	6 feet
ADA accessible ramps (including architectural features) and unenclosed stairwells	Full encroachment permitted; 0 feet to setback or boundary	
6 0 foot setback permitted at interior PLs		

Permitted encroachments shall not extend into the horizontal or vertical clear space required for fire access lanes.



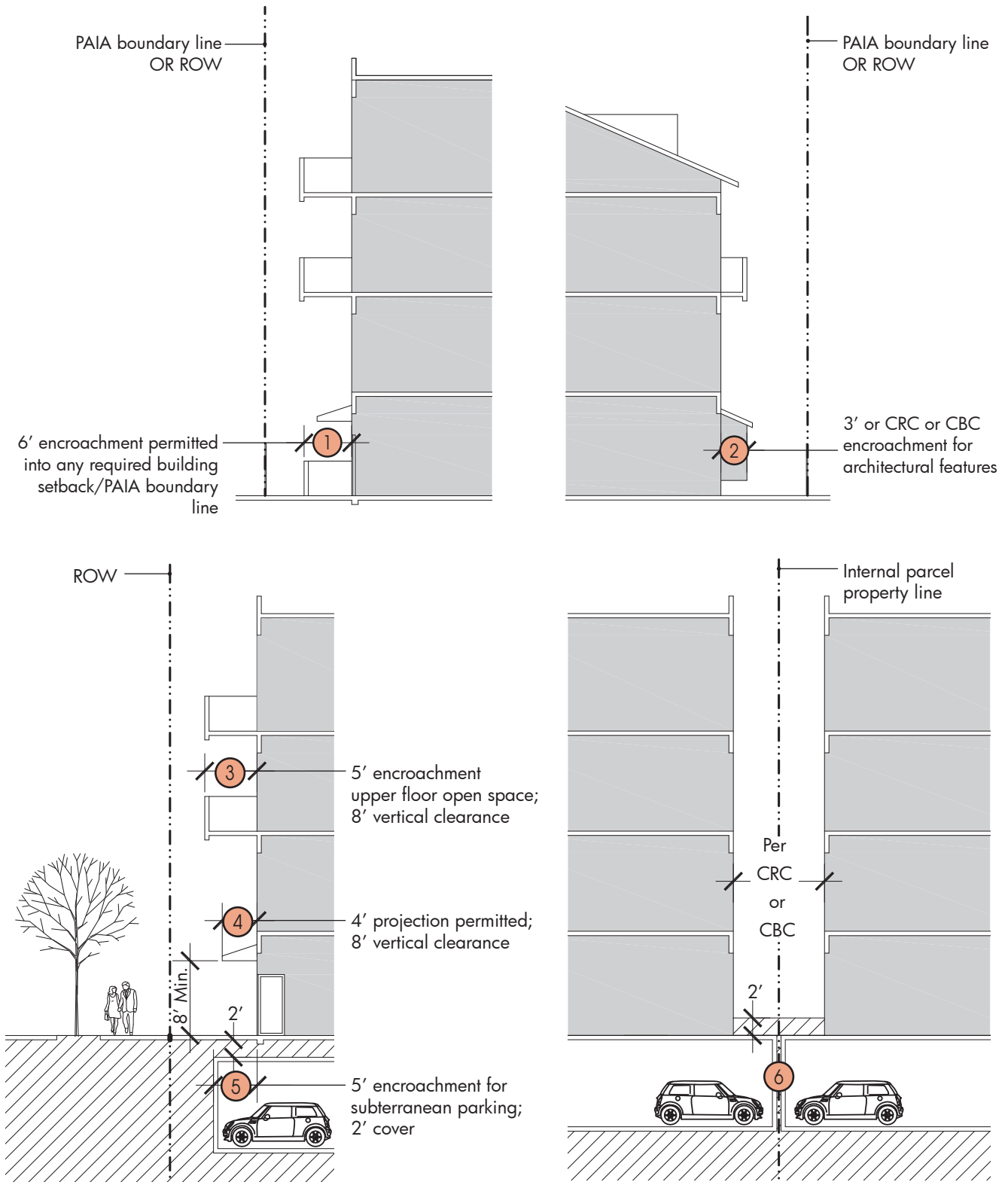
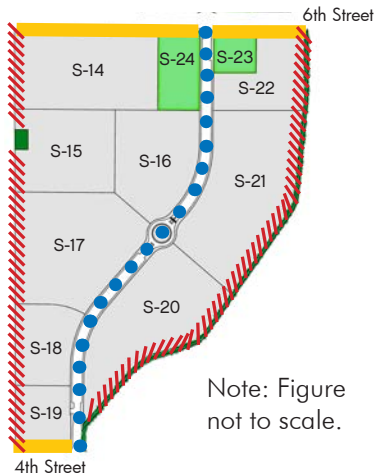

Figure 8.16: Encroachment Diagrams

B. Edge Conditions

Edge conditions of PAIA shall be treated consistent with Table 8.5: Perimeter Setbacks standards to maintain a sensitive and consistent treatment for adjoining properties. All internal parcel setbacks are established by Table 8.3: Development Standards.

All setbacks established by this section are minimum requirements and subject to encroachments permitted by Table 8.4: Permitted Encroachments.



Legend

PAIA Boundary Setbacks

① 10 feet minimum

② 2 feet minimum

PAIA Right-of-Way Setbacks

③ 10 feet minimum

④ 5 feet minimum

Figure 8.17: Setback Locations

Table 8.5: Perimeter Setbacks

PAIA Boundary Setbacks¹

Condition	Boundary	Minimum Setback	Maximum Setback	Applicable Parcels	Applicable Figures
①	Primary Edge	10 ft	None	S-14 S-15 S-17 S-18 S-19	Figure 8.18A: Primary Edge Section Figure 8.18B: Residential Edge Section
PAIA Right-of-Way Setbacks¹					
③	4th & 6th Streets Adjacency	10 ft	20 feet based on grading solutions	S-14 S-19 S-22 S-23 S-24	Figure 8.33: 6th Street Figure 8.35: 4th Street
④	The Vine	5 ft	10 feet	S-17 S-18 S-19 S-20 S-21 S-22 S-23 S-24	Figure 8.31: The Vine

1. All setbacks are measured from the primary wall plane of the building to the property line.



Primary Edge

Primary edge conditions shown on this page provide for pedestrian access and appropriate buffering from adjacent existing development. "Figure 8.18A: Primary Edge Section" applies to edge conditions adjacent to existing non-residential development. "Figure 8.18B: Residential Edge Section" applies to edge conditions along the eastern PAIA boundary line adjacent to existing residential development. Vehicular circulation in the form of a Collector Road or Private Drive Aisle at PAIA Boundary (Figure 8.35: Private Drive Aisle at PAIA Boundary) are also permitted adjacent to the PAIA boundary line.

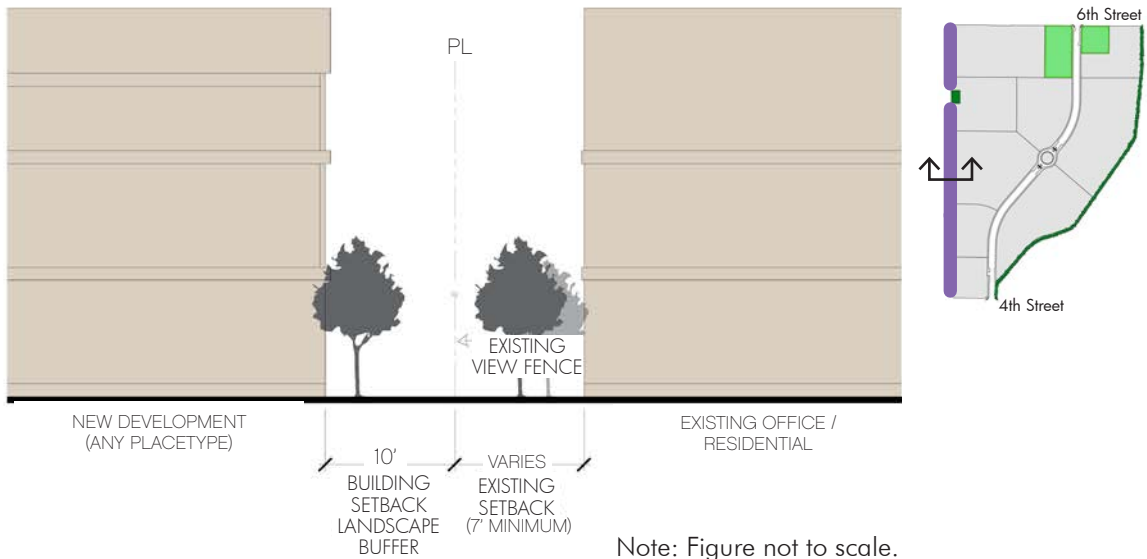

Note: Figure not to scale.
PL represents PAIA Boundary Line.

Figure 8.18A: Primary Edge Section

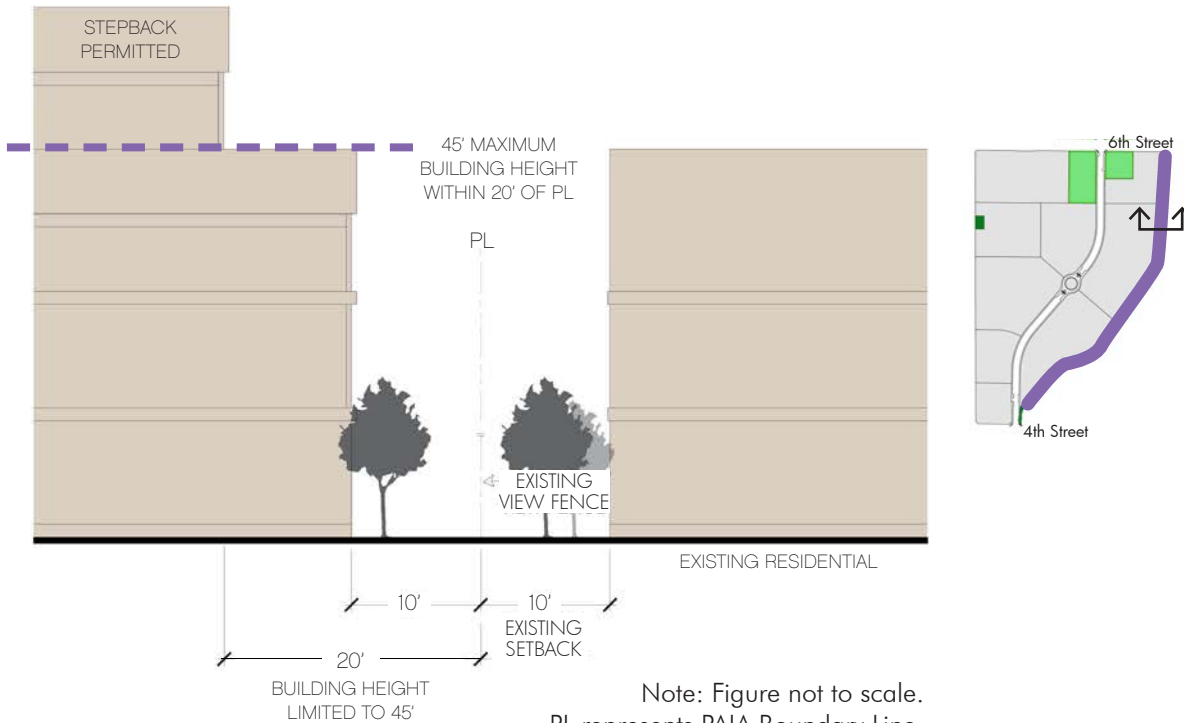

Note: Figure not to scale.
PL represents PAIA Boundary Line.

Figure 8.18B: Residential Edge Section

Rail Road Edge

Does not occur in PA1A **Gross Acres** Except as otherwise indicated, gross acres for all development areas are measured to the center line of streets.



C. Private/Public Open Space

Private and public open space are critical to the livability of a community. Minimum requirements are established in Table 8.3: Development Standards. These spaces may be provided in a range of configurations; from private ground floor porches, to recessed balconies, common courtyards, programmed outdoor spaces, or roof top decks.

- Private, ground level open space on the street side of a structure is to be suitably screened from streets based on condition and streetscape intent by a wall, fence, densely planted shrubs, or combination of these features.
- Common open space may be visible from the street without screening.
- Recreation amenities provided within the REC Placetype and along the Vine shall be counted toward the minimum requirement for any parcel.
- Common open space may be provided with the associated parcel or on an adjacent parcel as approved on an individual parcel basis during the site plan approval process.

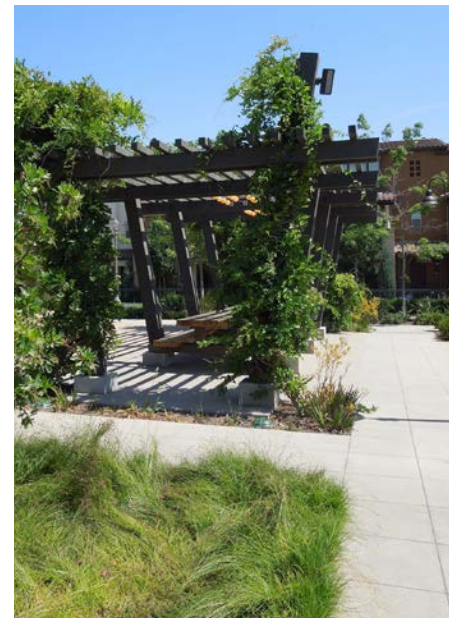
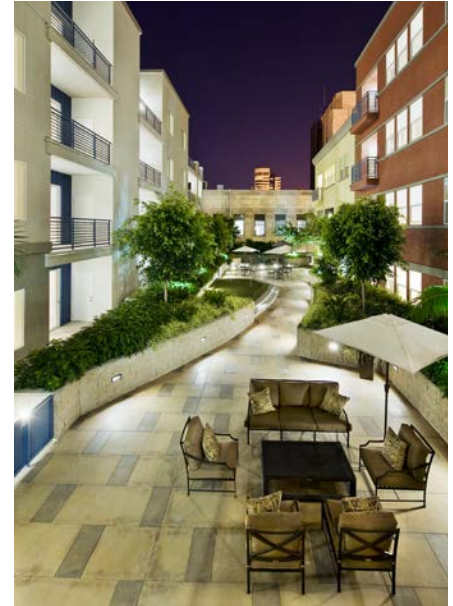

Examples of common and private open space

D. General Provisions

The following provisions shall apply to all proposed land development:

Private Open Space

May include but is not limited to: covered porches, patios, stoops, courtyards, balconies, yards, roof top decks, and similar spaces reserved for private use by a single unit.

Common Open Space

May include but is not limited to: verandas, plazas, courtyards, roof top decks, programmed or natural outdoor space, tot lots, dog parks, paseos and pathways, sitting areas, 3rd Place spaces, and similar spaces open for use by a group of homes, all homes, or the public.

Gross Acres Except as otherwise indicated, gross acres for all development areas are measured to the center line of streets.

Grading Development shall utilize grading techniques as approved by Rancho Cucamonga. Grading concepts shall respond to the Design Guidelines.

Building Modification Additions and alterations are permitted and shall match the architectural style of the primary unit and shall be constructed of the same materials, details, and colors as the primary unit.

Utilities All new and existing public utility distribution lines shall be placed underground, as feasible, to the extent allowed by the utility company(ies), and required by City Code.

Technology All homes and businesses shall accommodate modern telecommunications technology.

Best Management Practices Development of storm water runoff improvements shall adhere to currently adopted Best Management Practices (BMP's). The BMP's may include, but are not limited to, creating landscape strips and landscaped setback areas that can be swaled and depressed to retain and infiltrate irrigation water and runoff from smaller storm events, drain rooftops into rain gutters which would drain into an area of porous subgrade underground chambers, pervious storm drain pipes, and depressing the park areas to provide storm water infiltration and water quality treatment. Common area landscaping and parks may be designed to function as a series of shallow storm water treatment basins and infiltration zones for storm water runoff from surrounding areas wherever moderately well draining soils exist.

Solid Waste/Recycling Development shall comply with Residential Refuse, Recyclables and Green Waste Collection requirements of the City's Development Code. However, green waste collection may be collected by professional landscapers for the public areas of the development eliminating the requirement for individual green waste receptacles.



8.3.5 Parking Requirements

Provision of parking facilities for all land uses should be convenient and accessible, and encourage vitality associated with the development.

A. Approach to Parking

Livability of a community and neighborhood can be greatly impacted by the type and availability of parking. In urban settings, parking can be uncoupled from individual units for practical design and financial reasons, enabling an environment that promotes pedestrian access over vehicular storage. Parking should be available to meet resident and visitor needs; however, parking should not be so prevalent as to incentivize driving over other local multi-modal alternatives.

The method of parking utilized should respond to the home type, land use, and parking requirements of the parcel. Parking may be “un-coupled” from units, where a parking study validates the approach, enabling development of creative unit configurations that focus on living and mobility over parking provision. Parking may be provided in a variety of methods including, stand-alone or combinations of:

- Garages.
- Carports.
- Parking lots.
- Parking structures.
- Shared parking agreements.
- On-street spaces.

All on-site, off-site, and on-street parking will count toward a project’s required parking calculations; all on-street parking used to meet vehicle parking requirements shall be shown on plans during the development review and/or Tentative Map approval process, and may only be allocated to a single parcel or development (if comprised of multiple parcels). This approach will allow for increased flexibility and creativity in the design of home types and neighborhood configurations. In support of a robust urban parking approach, the Vine as shown on Figure 8.6: Conceptual Development Plan by Placetype, and collector roads, private drive aisle, and alleys may utilize on-street parallel parking or head-in spaces wherever feasible, and these spaces shall be counted towards the parking requirement.

All development is highly encouraged to leverage transit, multi-modal, and shared parking opportunities to reduce required parking demand. Parking reductions may be achieved through shared parking, or other strategies that reduce the amount of area devoted to parking and to increase the use of alternative forms of mobility, as validated by a Parking Demand Study.



Convenient on-street parking with landscape islands

B. Minimum Requirements

All development within PAI, regardless of land use or density, are subject to the requirements of Section A of Table 8.6: Parking Standards. Residential-only development of any density providing parking consistent with Table 17.64.050-1 of the City's Development Code is not required to prepare a parking demand study. Non-residential development is subject to Table 17.64.050-1 of the City's Development Code.

Residential development of 30 units/acre or less shall provide parking consistent with the number of parking spaces required by Table 17.64.050-1 of the City's Development Code, unless parking reductions are permitted pursuant to the provisions herein. Section B parking requirements of Table 8.6: Parking Standards are intended to serve as a baseline for parking provisions for higher density housing (residential development greater than 30 units/acre) and development in the MU and Mixed Use Overlay; a parking demand study shall be prepared to justify or modify this baseline requirement.

Table 8.6: Parking Standards

Minimum Parking Space Size and Driveway Depth for All Projects within Empire Lakes (All residential and mixed use)				
Section A Applicable to All PAIA Development	Space types qualifying as "required unit parking"	Single-car garages, tandem spaces, two-car garages, car lifts, on-street or off-street parking permitted to satisfy requirements;		
	Single-Car Garage ⁽³⁾	10 feet x 19 feet		
	Two-Car Side-by-Side Garage ⁽³⁾	19 feet x 19 feet		
	Two-Car Tandem Garage ⁽¹⁾⁽³⁾	10 feet x 39 feet (permitted if both spaces are assigned to the same unit)		
	Standard Head-In Space	9 feet x 18 feet; 16 foot depth permitted with 2-foot planting area overhang, OR 17-foot depth permitted with 1-foot planting area overhang		
	Parallel Space	8 feet x 24 feet		
	Driveway Depth/Setback to Garage Door	From Private Drive Aisle or Alley (as measured from back of ROW)		
	Residential	2-5 feet or ≥ 18 feet	2-5 feet or ≥ 18 feet	
Section B Parking Requirements	Standard	Residential Development of 30 du/acre or less		
	Required Unit Parking	Table 17.64.050-1 of the City's Development Code		
	Standard	Residential Development >30 du/acre	MU/Mixed Use Overlay	
	Required Unit Parking ⁽¹⁾			
	Studio			
	1 Bedroom	1.3 spaces/unit, (may be an enclosed space)	1 space/unit, (may be an enclosed space)	
	2 Bedrooms			
	3 Bedrooms			
	4 or More Bedrooms	2 spaces/unit (with 1 enclosed space)	1.5 spaces/unit (with 1 enclosed space)	
	Live/Work & Shopkeeper Units ⁽²⁾	As required based on bedroom count	Varies	
	Age-Qualified/Senior Units	1 space/unit		
	Required Guest Parking ⁽²⁾			
	Residential	1 space/4 units ⁽²⁾	1 space/5 units ⁽²⁾	
	Live/Work	1 space/2 units		
	Shopkeeper	1.5 spaces/unit		
Age-Qualified/Senior Units	1 space/10 units			
Bicycle - Residential	None	Per CALGreen standards where applicable		
Bicycle - Non-Residential	Per CALGreen standards			

⁽¹⁾ Tandem garage parking counts as 2 parking spaces for all residential densities and mixed use configurations.

⁽²⁾ Guest parking space location is not limited to dwelling unit proximity per City's Development Code; actual distance to be reviewed by the City.

⁽³⁾ Maximum 2 steps permitted within minimum garage dimension.

⁽⁴⁾ When the calculation of the required number of parking spaces results in a fraction of a space, the number of spaces shall be rounded up to the nearest whole number.



Residential Parking Spaces

Residential units in all Placetypes may provide required parking as attached or detached garage space(s), or assigned or unassigned parking in carport, parking lot, parking structure, on-street, including public streets, or a combination of these spaces. Where garage parking is provided, internal dimensions shall be consistent with Table 8.6: Parking Standards.

Uses Not Specified

If a land use is not specified in the City’s Development Code, the number of parking spaces required shall be determined by the Planning Director. The recommendations of a project-specific parking demand study, and review of common function, product, and compatibility characteristics of the proposed use may be used in making the determination.

C. Parking Modification/Reduction

A Parking Demand Study is required to be completed for:

- All mixed use development occurring within the MU Placetype.
- All mixed use development occurring within the Mixed Use Overlay, only to the extent it is utilized for mixed use.
- Residential development greater than 30 units/acre.

A Parking Demand Study may be utilized:

- On a project-specific basis, regardless of density or land use type, to reduce minimum parking requirements

Reductions in required parking may only be permitted where the Parking Demand Study demonstrates the actual parking demand would be less than the requirements and/or that shared parking between uses is appropriate. The Parking Demand Study may also consider progressive parking management strategies.

A progressive parking management strategy could be developed to reduce parking requirements in conjunction with a Parking Demand Study. This parking management program could consist of shared parking per Section 17.64.060(B) or other solutions such as, valet services, monitored parking, storage within the unit and not within garage (view windows on garages), HOA enforcement of number of vehicles per unit, guest parking time restriction, shuttles, car-/bicycle-share program, or some other parking management system or progressive parking strategy if approved by the Planning Director.



Covered guest and resident parking



Covered parking in-lieu of garage parking; parking “un-coupled” from units



Bicycle and car share programs could be used to reduce the amount of land devoted to parking



Recessed garage conditions with upper story projections



Garage parking accessed from a Private Drive/Alley

Shared parking shall be managed by a property owners' association and shared between uses, subject to Reductions in Parking Requirements per the City's Development Code.

D. Private Garages

Private garage configurations that satisfy "enclosed space" requirement, may be front-, side-, or rear-loaded, and may exhibit a variety of siting conditions suitable to the building type. Driveway depth/setbacks to private garages shall be consistent with Table 8.6: Parking Standards. Refer to "Figure 8.20: Driveway/Garage Door Setbacks" for more detail.

- ① For residential units taking garage access from a Private Drive Aisle or Alley, driveway depth shall be two to five feet or 18 feet or greater.
- ② Split-car garages (single- or two-car configurations) are not required to have matching driveways depths (i.e. one garage can have a two-foot drive apron and the other garage can have an 18-foot driveway).
- ③ Upper stories are permitted to maintain the minimum building setback by sheltering or cantilevering over recessed garages.
- ④ Individual or common car lifts are permitted and shall count as enclosed spaces for as many cars as they are designed to handle.

E. General Standards

- Parking areas and structures may be gated and managed by the property owner to ensure there is adequate resident and guest parking.
- The vehicular and pedestrian access points shall be designed for high visibility.
- Appropriate throat length shall be provided between parking and the right-of-way for all mixed use and non-residential development to enable queuing, turning radii, and internal circulation.
- Developments utilizing off-site parking facilities shall have clearly visible signage indicating where that parking is located.
- Parking in driveways shall be prohibited, except where driveways of 18 feet or greater are provided.
- Driveways for private garage access are not permitted along the Vine, 6th and 7th Streets. Deviations from these requirements that are necessary due to unusual site characteristics/circumstances are subject to the review and approval of the Planning Director/Planning Commission.



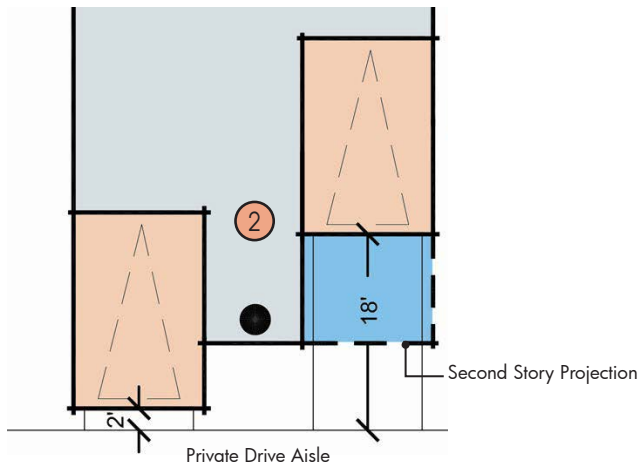

Split-car garages with driveways of different lengths

Legend

- Garage
- Second story overhang/projection
- Living area

Note: Figure not to scale.

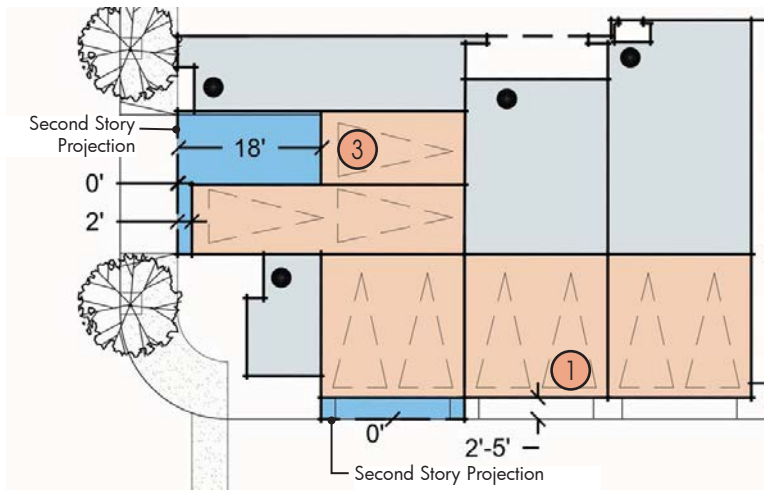

Driveway depth/garage door setbacks for attached homes as accessed from Private Drive Aisle and Alleys



Car lift example, can be used in private garage or shared parking structures

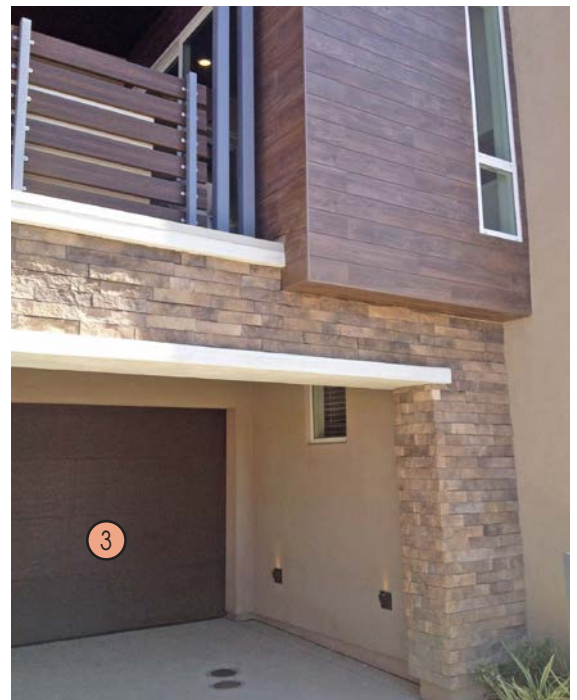

Recessed garage with driveway sheltered by upper stories (building wall plane and upper stories meet minimum setbacks)

Figure 8.20: Driveway/Garage Door Setbacks



Landscaped parking area within a multi-story motorcourt product



Landscaping and striping have a positive impact on lot design



Trees located in planters

- Driveways to access parking lots or garages for more than ten units (such as ground floor parking in a wrap product configuration) are permitted subject to traffic considerations.

F. Parking Lot Design

Large parking fields shall be broken into smaller connected lots that utilize shared driveways and incorporate pedestrian connections and landscape buffers. Pedestrian walkways connecting parking with building entrances are encouraged.

The following standards shall apply to all parking lots:

- Parking areas should be designed to allow for pedestrian connectivity through the use of walkways, enhanced pavement striping, trellis structures, and/or landscape treatments.
- Trees located within parking lots shall be located within planters.
- Planters shall be bounded by a concrete curb or mow strip, unless intended to be used as landscaped swales for water quality purposes.
- Tree canopies in planters shall maintain vertical clearance of seven feet above the ground and not encroach into required horizontal or vertical clear space of fire access lanes.

Landscaping in parking lot planters shall not obstruct the ability for police or security to properly view the area.

G. Parking Structure(s)

Parking structures include any multi-level garage or structure designed to serve non-residential uses and/or multiple residential units. Parking structures shall:

- Clearly delineate vehicular and pedestrian entries and separate them where feasible.
- Combine tenant, resident, and guest parking in the same entry, where feasible and applicable.
- Clearly mark reserved and guest parking, where applicable, on the stall by paint or placard.
- Control vehicle headlight and rooftop lighting spill-over.
- Be equipped with the required fire suppression systems and provide appropriate fire access in accordance with the current adopted editions of the California Building Code, fire code, and local ordinances.





Parking structures, single- or multi-level, may be utilized at or below grade as a method of taking up grade. At-grade parking structures shall be sensitively designed and planned to balance grade change with pedestrian circulation.

Parking structures adjacent to public streets shall be enhanced or screened from public street view. One or more of the following design techniques shall be used to enhance or screen parking structures:

- Wrap exposed garage elevations with enhanced architecture, retail, or residential units.
- Design to complement the design vocabulary of the attached or adjacent buildings (including roof/parapet/fascia treatment).
- Use sufficient landscaping or active architecture to provide adequate screening at the pedestrian level to decrease the feeling of uninhabited space along the street.
- Incorporate decorative screening, greenscape screen, artistic murals, or application of stylized façades.
- Incorporate form, materials, color, and details that are utilized on the attached and/or adjacent building.
- Incorporate openings to permit natural light and ventilation into the structure.
- Promote defensible space safety with warm lighting, ample heights, and clearly-defined pedestrian corridors.

Parking structures internal to a building, surrounded by units or development features, and not visible from an off-parcel public street shall be exempt from the design techniques listed above.

Parking structures within 5-minute walk of the Metrolink station are not required to screen the parking structures from view.



Garage signage assists visitors



Garage design has minimal impact on streetscape



Architectural garage screening



Mural garage screening



Window openings allow natural light & ventilation

8.3.6 Circulation

The circulation plan addresses both regional and local circulation requirements and reinforces the goal of creating a pedestrian-friendly environment. The overall circulation concept places an emphasis on pedestrian, bicycle, and vehicular connectivity emanating from the Metrolink station and major circulation corridors. Figure 8.21: Transit Circulation shows connections to the local transit system; Figure 8.22: Overall Circulation Diagram identifies the major internal circulation of PAIA.

A. Transit

The Metrolink Rancho Cucamonga Station is located northeast of PAIA and west of Milliken Avenue on the San Bernardino Line. Passenger trains run daily from downtown Los Angeles to downtown San Bernardino. This same rail line is occasionally used by freight trains when the Union Pacific Railroad line (running east-west south of I-10) is closed or restricted for limited periods.

Omnitrans Transit Agency provides local transit service throughout San Bernardino County, including the City of Rancho Cucamonga. Bus transit services are available in the City through fixed-route and demand-response services. The bus routes serve major destinations in the region and run on major roadways, including Haven Avenue, Milliken Avenue, and on segments of 4th Street.

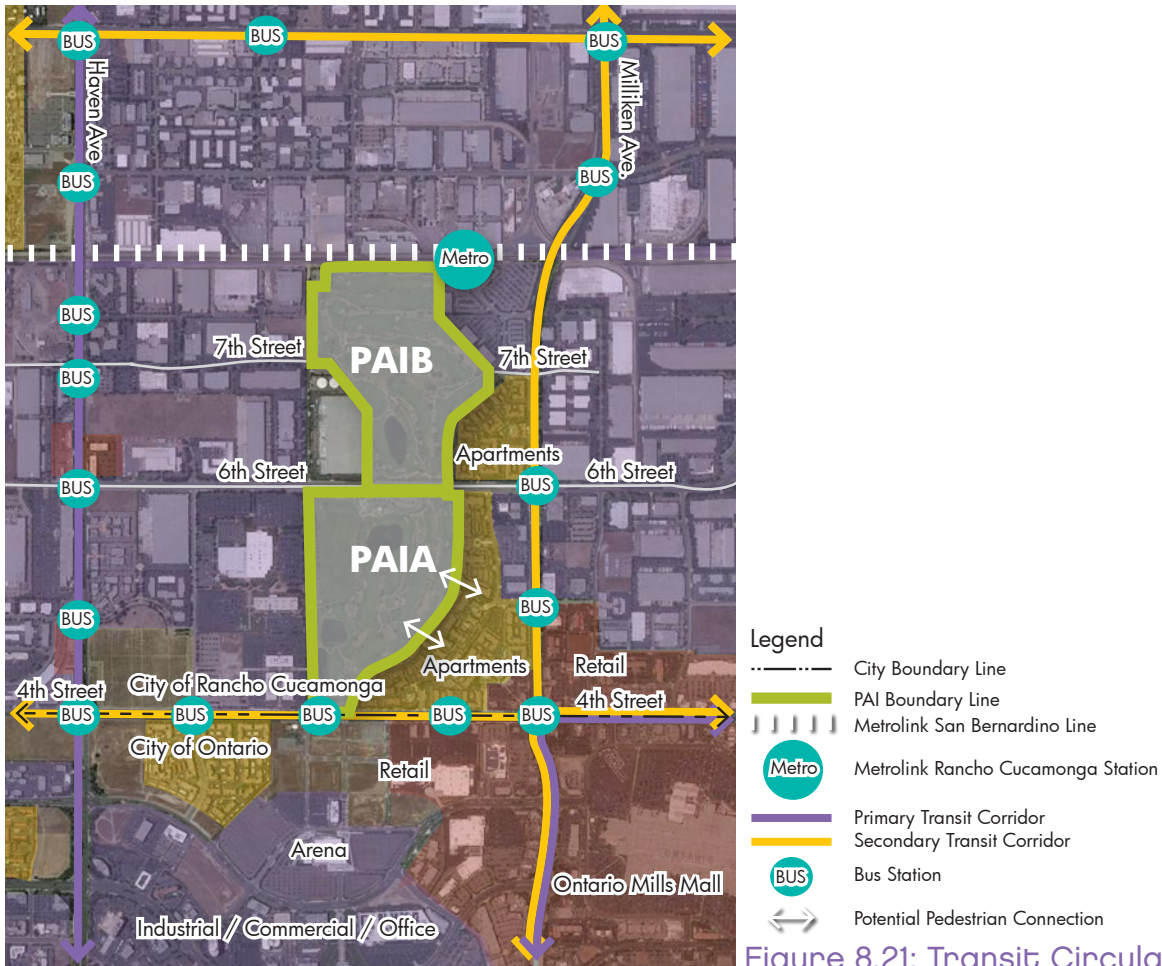

- Legend**
- City Boundary Line
 - PAI Boundary Line
 - Metrolink San Bernardino Line
 - Metrolink Rancho Cucamonga Station
 - Primary Transit Corridor
 - Secondary Transit Corridor
 - Bus Station
 - Potential Pedestrian Connection

Figure 8.21: Transit Circulation

Note: Figure not to scale.



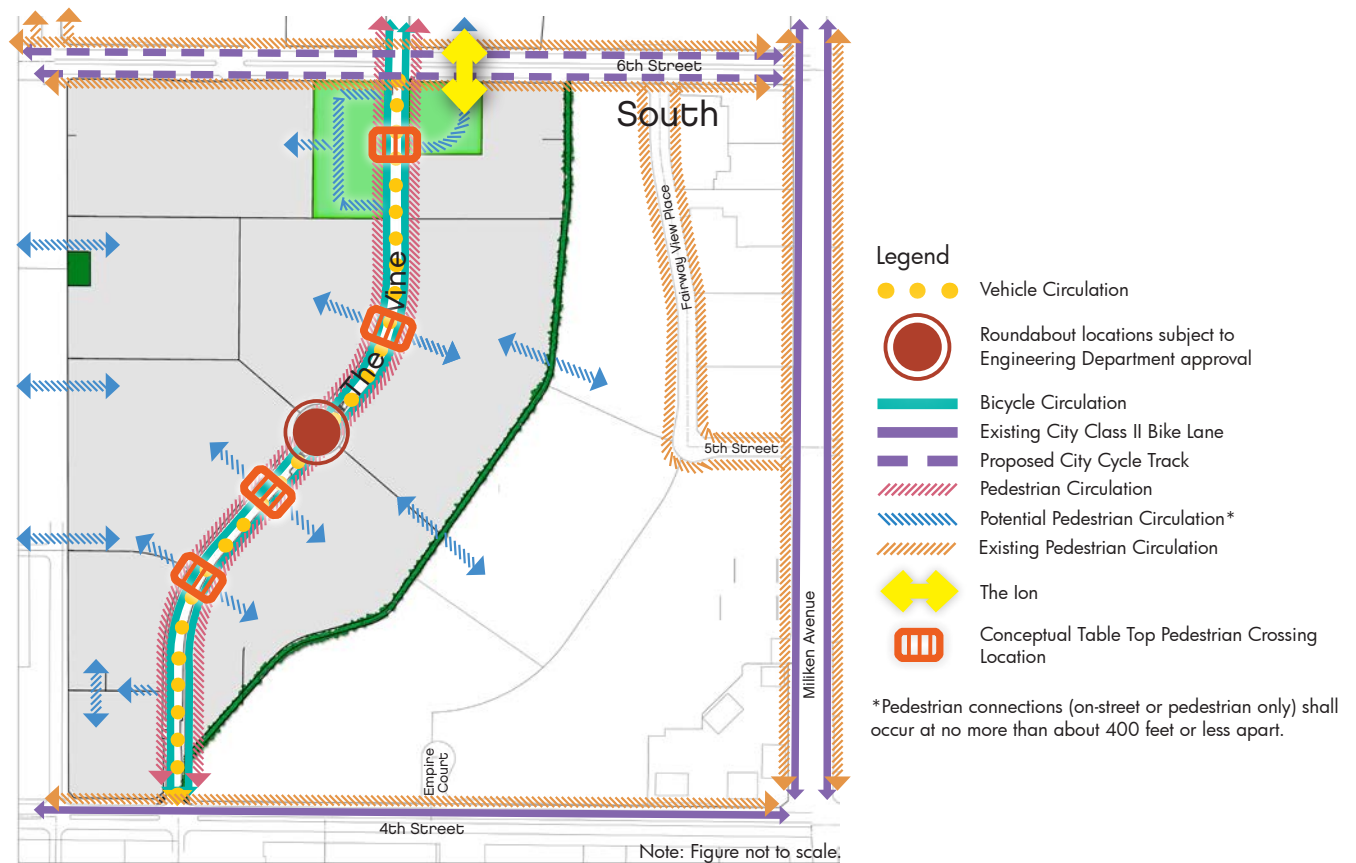

Figure 8.22: Overall Circulation Diagram



The circulation network includes on-street parking and sustainable features

B. Vehicle Network

From a transportation point of view, the main objective of PAIA is to establish an in-fill mixed use community that will improve transportation efficiencies and ultimately reduce the number of vehicle trips.

The street network is designed to provide low speed circulation and efficient movement throughout the community. Traffic calming measures such as roundabouts, traffic circles, bulb-outs, chicanes, mid-block pedestrian crossings and Table Top pedestrian crossing may be used.

The main vehicular access to the site is from 4th and 6th streets. The Vine provides the main north/south circulation within PAIA.

PAIA is served internally by a bent grid network of residential collector roadways and private drive aisles designed with on-street parking, urban street frontages, shaded pedestrian links, and open spaces.

All streets shown on Figure 8.6: Conceptual Development Plan by Placetype shall be public streets.

Site planning of parcels should create a high level of pedestrian access throughout and maintain efficient vehicular circulation.

- All roadways within parcels shall be designed as a "grid" or "bent-grid," to the greatest extent feasible.
- At least two points of vehicular access will be provided for each development. Interconnections with adjoining planning areas/developments may be provided where necessary to achieve the required access.
- Use of cul-de-sacs shall be limited to necessary site plan/parcel conditions where fire access or street maintenance turn around is required, subject to the review and approval of the Planning Director.



The dimensions and details of each street type, and major intersection or circulation features, are identified in Figure 8.25: Conceptual Ion Sections through Figure 8.36: Alley Section.

C. Bicycle Circulation

Bike Lane Standards

There is an existing City Class II Bike Lane located on 4th Street. There is a proposed City cycle track on 6th Street; the portion along the Empire Lakes frontage will be installed at the time of development. The Vine will provide buffered bicycle lanes allowing connection between 6th Street and 4th Street. Refer to Figure 8.33: 6th Street and Figure 8.35: 4th Street.

D. Pedestrian Circulation

Walkability and pedestrian access are prioritized by the PAIA development pattern. Design of streets, the pedestrian realm, and the built environment will provide an engaging and direct means of walking through the community. Each parcel will provide for pedestrian pathways and connections to adjacent parcels and the Vine to facilitate effective multi-modal connectivity to Mixed Use and transit services. See Figure 8.24: Pedestrian Circulation Diagram.

Currently there are sidewalks on 4th and 6th Streets with a parkway on 6th Street. Crosswalks are provided where pedestrian crossings are allowed.

The PAIA primary pedestrian circulation feature is the 16-foot pedestrian realm provided on each side of the Vine that links with 4th Street and the Metrolink Station. This space will provide strong north/south connectivity throughout. The pedestrian realm will be designed with vegetation and hardscape elements to promote visual interest and active use across the Vine. See figures in Section 8.5.1.C. 3rd Place Spaces for detailed plans of pedestrian circulation features such as Grand Paseos, pedestrian connectors, gathering spaces, bark parks and pathways).



Note: Figure not to scale.

Legend





-  Roundabout locations subject to Engineering Department approval
-  Bicycle Circulation
-  Existing City Class II Bike Lane
-  Proposed City Cycle Track

Figure 8.23: Bicycle Circulation Diagram



Legend

Note: Figure not to scale.

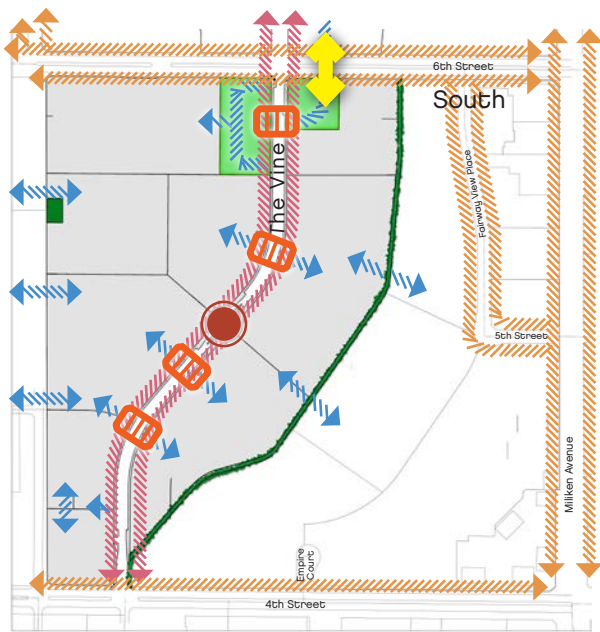





-  Roundabout locations subject to Engineering Department approval
-  Pedestrian Circulation
-  Potential Pedestrian Circulation
-  Existing Pedestrian Circulation
-  The Ion
-  Conceptual Table Top Pedestrian Crossing Location

Figure 8.24: Pedestrian Circulation Diagram

Interior circulation corridors are a major setting for daily living within the community. These spaces provide a comfortable pedestrian atmosphere and activate pedestrian and urban spaces. Pedestrian and circulation routes shall be:

- Intuitive.
- Well-defined.
- Easily discernible for appropriate and functional maneuverability and activity levels.
- Facilitate convenient pedestrian access, with building breaks and pathways, to all primary and secondary elevations.
- At no more than about 400 feet or less intervals (except for 500 feet north of 4th Street and north of the north roundabout) subject to Planning and Engineering Department approval. This may be accomplished by providing street connections, building breaks, or pathways through the building to provide pedestrian connectivity to the Vine.
- Direct pathways to transit facilities for all transit-adjacent parcels.
- Clear pathways between 3rd place spaces, the Vine, or public sidewalks.
- Identified with route signage (for basic navigation and public safety) and contain pedestrian-level lighting, trash receptacles, and bicycle storage racks where appropriate.

Connections may be formal pathways or paseos, a street connection with sidewalks, or may be informal spaces such as building breaks, 3rd Place spaces, walkways, or similar design features. They should:

- Provide pedestrian connections from the public sidewalk to key areas within or adjacent to the site.
- Encourage interconnecting walkways between buildings.

Mid-block street crossings shall be provided for every block along the Vine subject to Engineering Department approval. Pedestrian crossings include crosswalks at intersections, crosswalks with center islands, and Table Top crossings. Pedestrian crossing intervals are affected by site configurations, visibility and safety concerns.



Grand Paseos

Grand Paseos provide east/west open space corridors connecting neighborhoods to the Vine. These should be active spaces designed for pedestrian connectivity, dog walking, and exercise. A minimum of four grand paseos shall be provided; two occurring south of 6th Street and two occurring north of 6th Street. See Section 8.5.1.C. 3rd Place Spaces for additional landscape and amenity requirements.



The circulation network includes pedestrian paths.



The Ion

The Ion is an improved pedestrian pathway providing direct connection from the Vine and Urban Plazas under 6th Street. Appropriate signage and lighting will be installed. Light-based design features will enhance the experience of the pathway. Refer to Figure 8.25: Conceptual Ion Sections and Figure 8.26: Conceptual Ion Plan. Storm water runoff within the below surface Ion will be collected and conveyed by privately maintained catch basins and storm drain pipe to a public storm drain system within the Vine. Site design to be coordinated with the City to control access.

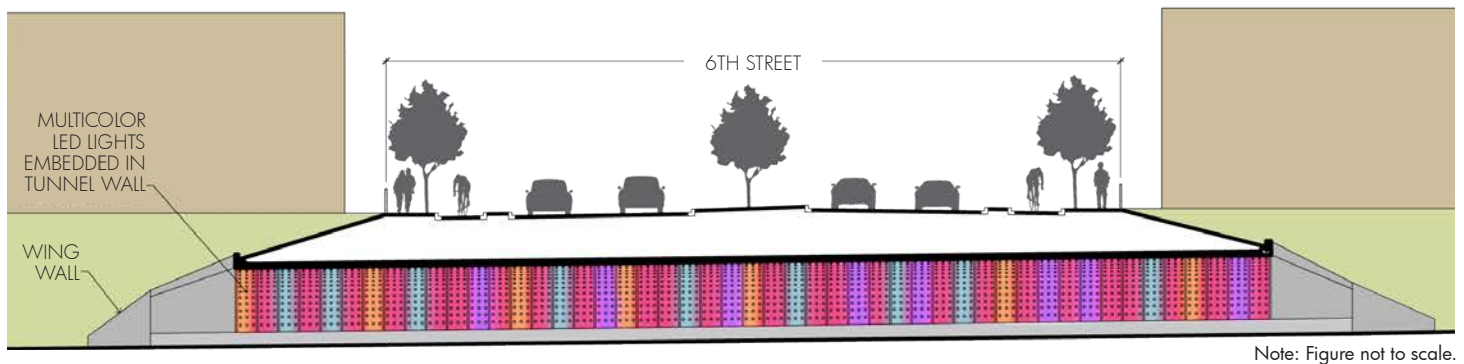
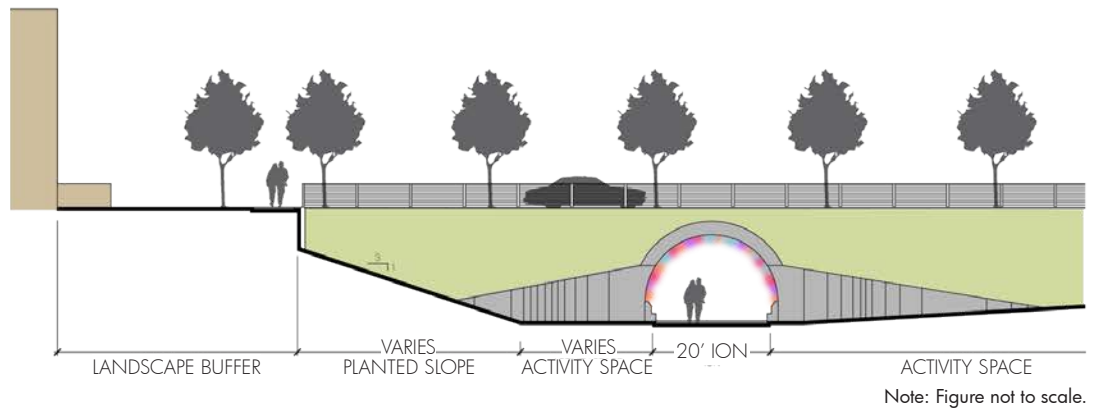
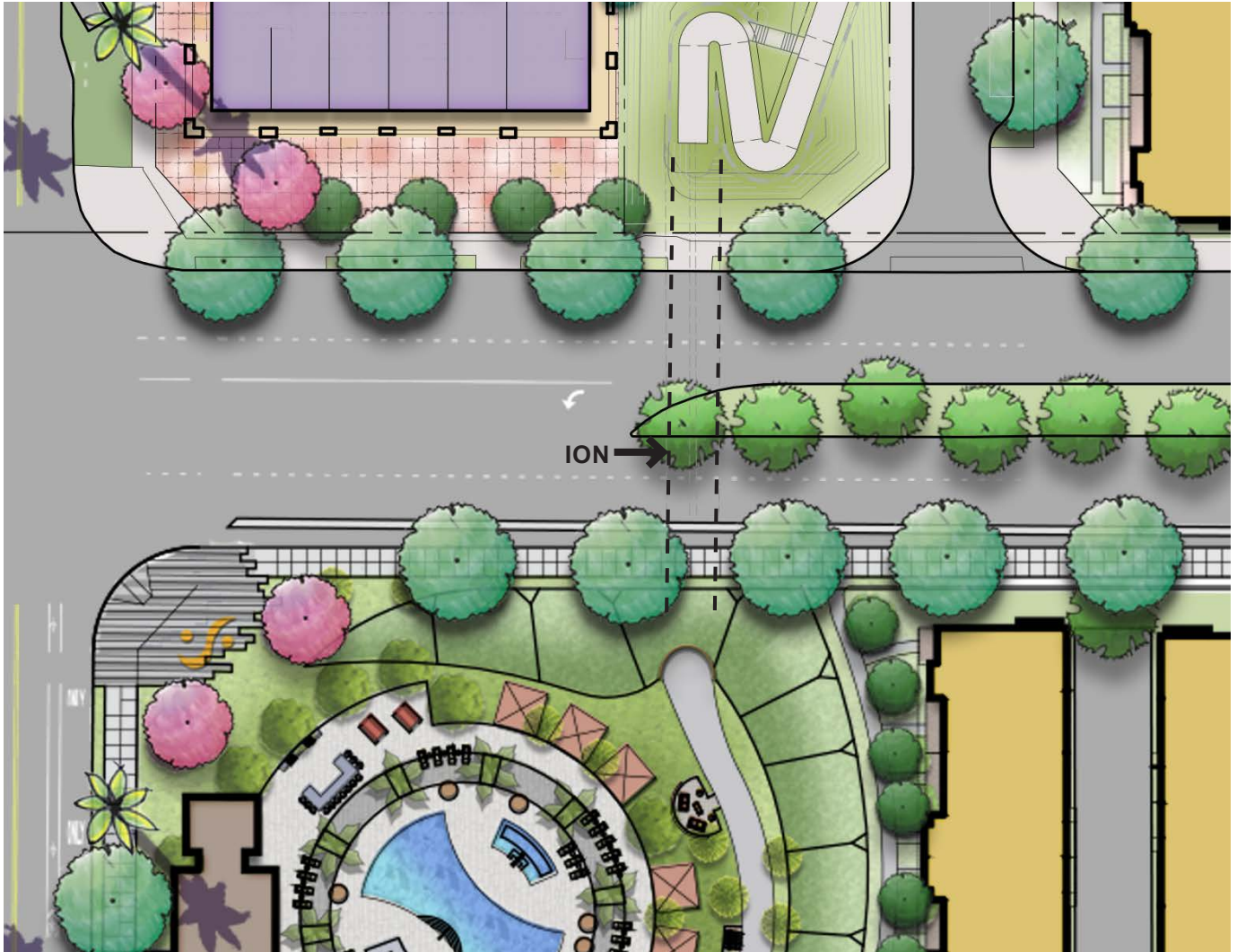

Figure 8.25: Conceptual Ion Sections





Note: Figure not to scale.

Figure 8.26: Conceptual Ion Plan



Table Top Pedestrian Crossing Example

Table Top Pedestrian Crossings/Tapered Street Access across the Vine, enhancing east/west connection within the community, may be provided by Table Top pedestrian crossings. These crossing amenities are longer than speed humps and flat-topped, with a height of three to three and a half inches and a length of 22 feet. They are often designed using textured materials, such as unit pavers, or colored designs on the flat-topped section. These distinctive materials help to highlight and define the Table Top pedestrian crossing for drivers, bicyclists, and pedestrians. Bulb-outs of the pedestrian realm are encouraged at Table Top Crossings to create tapered streets; this provides an additional visual element that slows traffic and makes the pedestrian crossing distance shorter.

Table Top pedestrian crossings can be used on the Vine and other required Fire Apparatus Access Roads, subject to the approval of RCFPD and City Engineering Department. These Table Top pedestrian crossings will be designed as mid-block crossings, often in conjunction with curb extensions.



Figure 8.27: Conceptual Table Top Pedestrian Crossing Rendering



Figure 8.3: Design Concept, Figure 8.22: Overall Circulation Diagram, Figure 8.24: Pedestrian Circulation Diagram and Figure 8.29: Vehicular Circulation Diagram locate opportunities to provide a mid-block Table Top Crossings. Final locations of mid-block table crossings are subject to traffic engineering requirements and review and approval by the City.

Use of Table Top crossing is appropriate only in urbanized settings that are specifically designed to encourage low vehicular speeds and promote increased use of pedestrian bicycle modes. Table Top pedestrian crossings shall be designed to the following criteria:

- Cross two-lane roadways with 11-foot or narrower vehicle lanes, bicycle facilities (i.e. Class I, Class II [buffered] or Class IV [cycle track]), sidewalks with widths greater than six feet, and other features to ensure lower vehicle speeds of less than 35 MPH.
- Located mid-block and incorporate other warning or control devices such as Rapid Rectangular Flashing Beacons (RRFB) to enhance the visibility of the crossing.

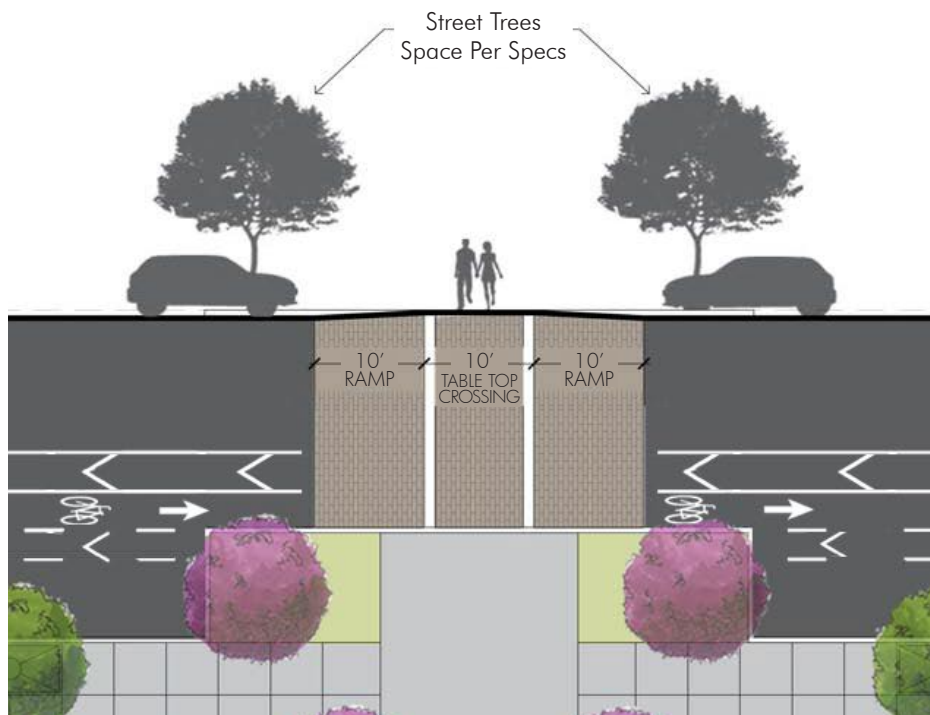

Figure 8.28: Table Top Pedestrian Crossing/Tapered Street



Legend



- ● ● Vehicle Circulation
-  Roundabout locations subject to Engineering Department approval
-  Conceptual Table Top Pedestrian Crossing Location

Figure 8.29: Vehicular Circulation Diagram

- Slopes should not exceed 1:10 or be less steep than 1:25.
- Side slopes on tapers should be no greater than 1:6.
- Any vertical lip should be no more than a quarter-inch high.

Bulb-outs to taper streets for pedestrian realm enhancement or to provide shorter standard crosswalks are also permitted.

E. Vehicular Circulation

The street and circulation feature sections in Figures 8.21 through 8.36 establish standards for vehicular circulation throughout PAI. All streets and features shall promote efficient circulation of vehicles, bicycles, and pedestrians. Incorporation of traffic calming features is highly encouraged as feasible based on traffic analysis.

The location and alignment of residential streets for interior circulation (Collector Streets, Private Drive Aisles, and Alleys) will be established at the time of tentative map submittal.

Where parallel or perpendicular street parking is shown on the following figures, diagonal parking may be substituted as an appropriate parking option subject to RCFPD and City Engineering Department approval.

The Vine and the Secondary Access Roads are the only Aerial Fire Apparatus Access Roads for PAI.



The Vine

The Vine is a public street serving as the spine of the community designed to facilitate multi-modal circulation options within the community and provide a visually engaging center to the community. The Vine design concept spans from building face to building face and incorporates the entire pedestrian realm as a space for movement and gathering. See Figure 8.31: The Vine.

The design of the Vine shall:

- Use vertical elements (such as tree massing, cadence of palms, or monuments, overhead string lighting, and tree rows spanning the space) as unifying features.
- Contains one travel lane each way; center turn lanes to be provided only at intersections where high left turn volumes are anticipated, as required by a traffic study.



Figure 8.30: Conceptual Vine Rendering

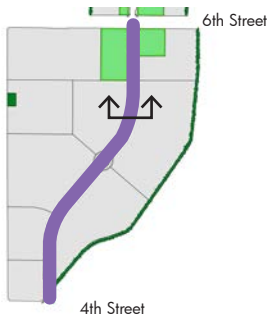

- Contains a bike lane in each direction with a 4-foot travel lane buffer and 3-foot parking buffer.
- Include a parking zone where feasible.
- Use vegetation and hardscape elements on both edges to promote visual interest and active use across the space.
- Include Table Top and mid-block pedestrian crossings at logical locations connecting 3rd Place spaces and open space activity areas for effective pedestrian access and traffic calming.
- Conform to the City's Street Design, Line of Sight, and Driveway policies.

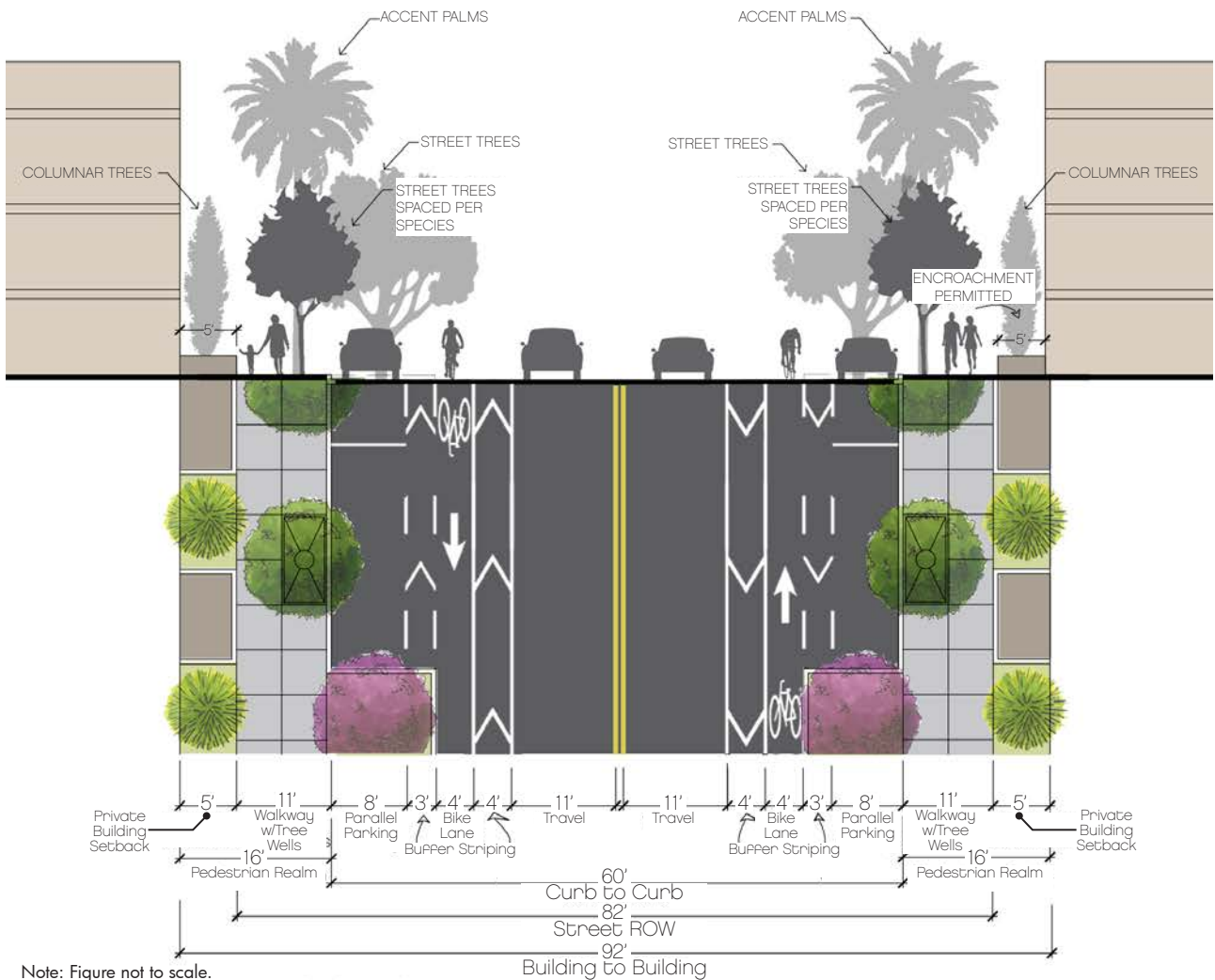

Note: Figure not to scale.

Figure 8.31: The Vine



Roundabouts

Roundabouts conceptually illustrated in Figure 8.32: Typical Roundabout Plan, will be located as a traffic calming and entry features. As part of the central circulation corridor, roundabouts will be public street improvements. Designs will be consistent with City standards. Additional roundabout locations and detailed design are subject to Engineering Department approval.

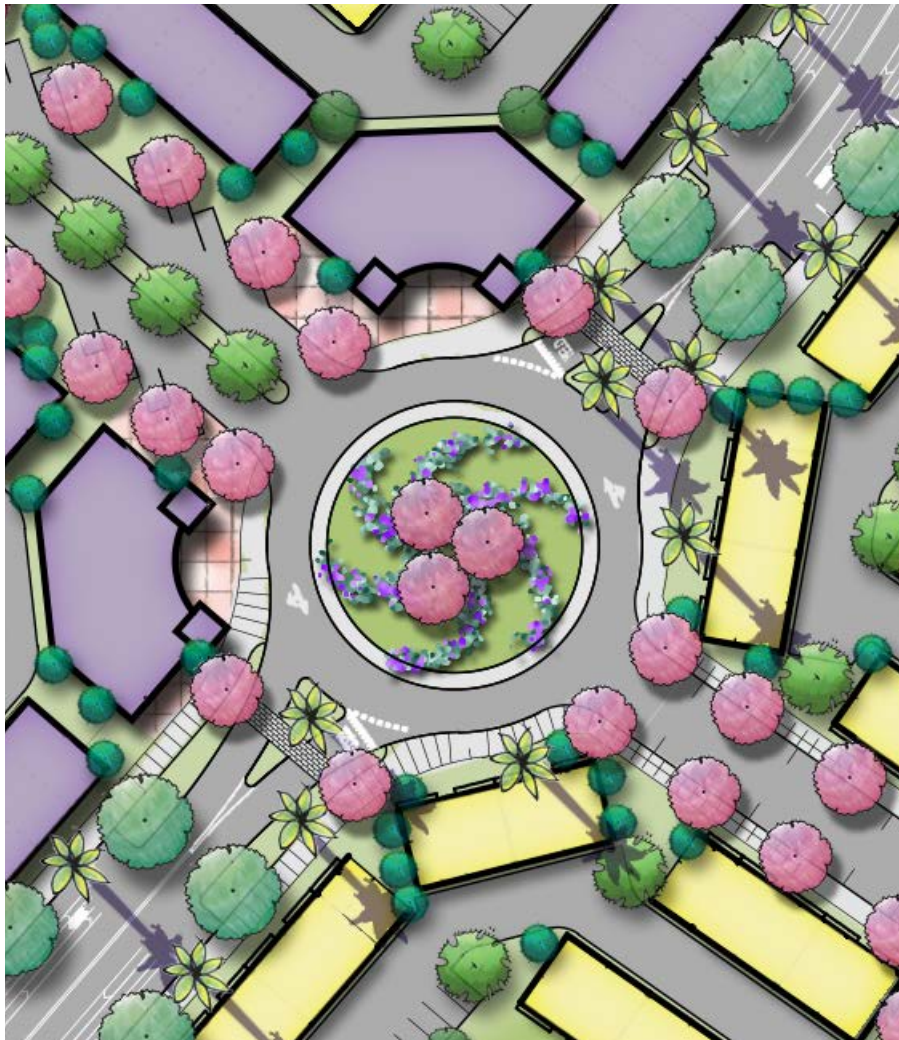

Note: Final configuration subject to Engineering Department approval; figure not to scale.

Figure 8.32: Typical Roundabout Plan

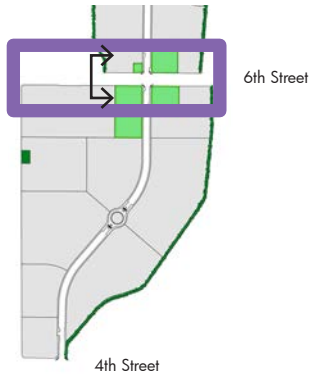

6th Street

6th Street is a public street maintained by the City of Rancho Cucamonga. The City has established a plan for installing a cycle track on 6th Street with raised medians provided to protect the bike lanes. This feature will tie in with the on-street bike lanes of the Vine and provide heightened bicycle circulation to City and regional destinations.

6th Street serves as a primary east/west arterial. 6th Street consists of a planted median with Cape Myrtle trees and large screen massing trees on both north and south edges. The 6th Street geometry shall be modified to include a landscaped parkway with a row of street trees along both sides of the street that will serve as a buffer between pedestrians and vehicles.

All buildings located adjacent to 6th Street shall have a landscape buffer. Monumentation at community entries will be provided.

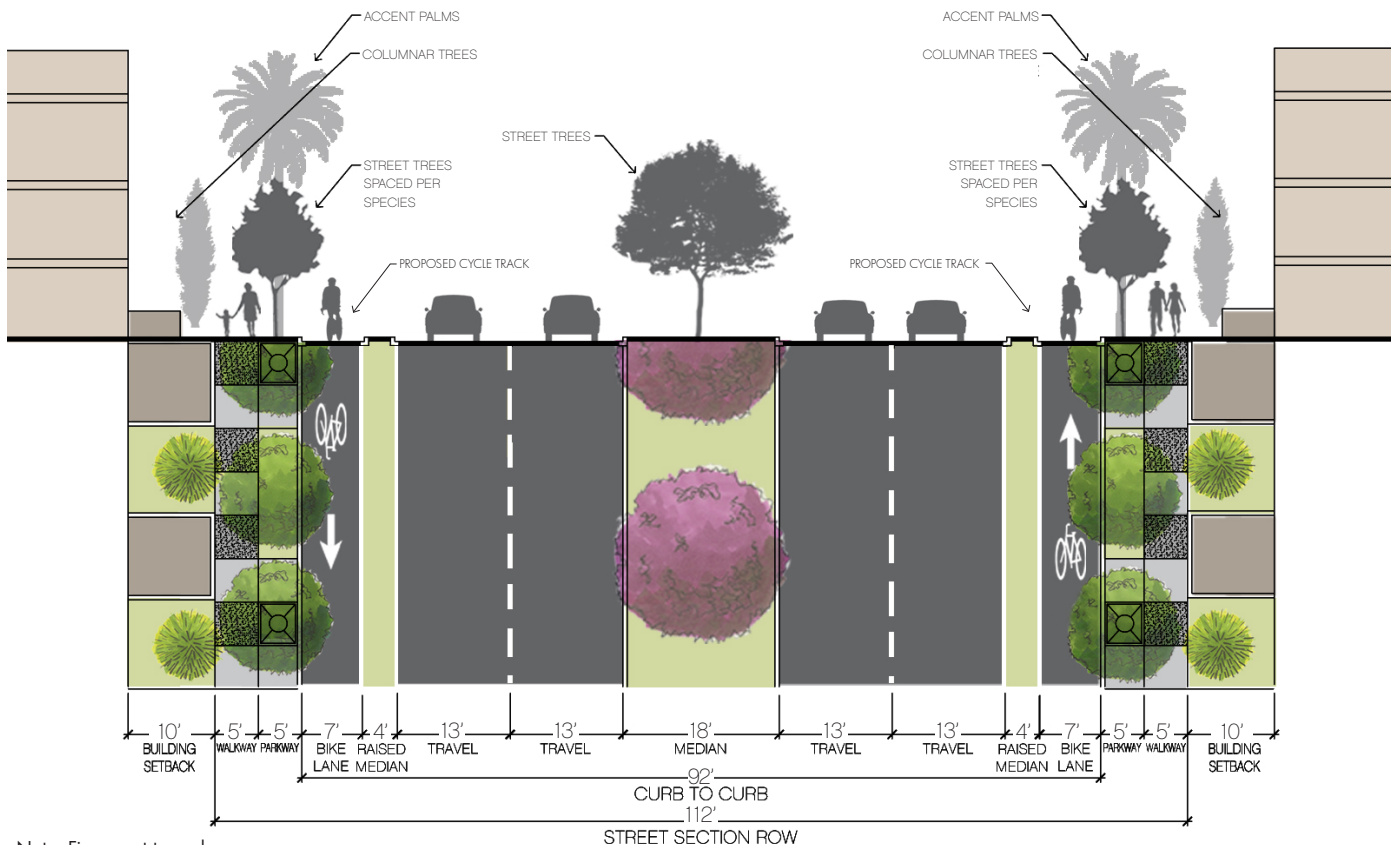

Note: Figure not to scale.

Figure 8.33: 6th Street



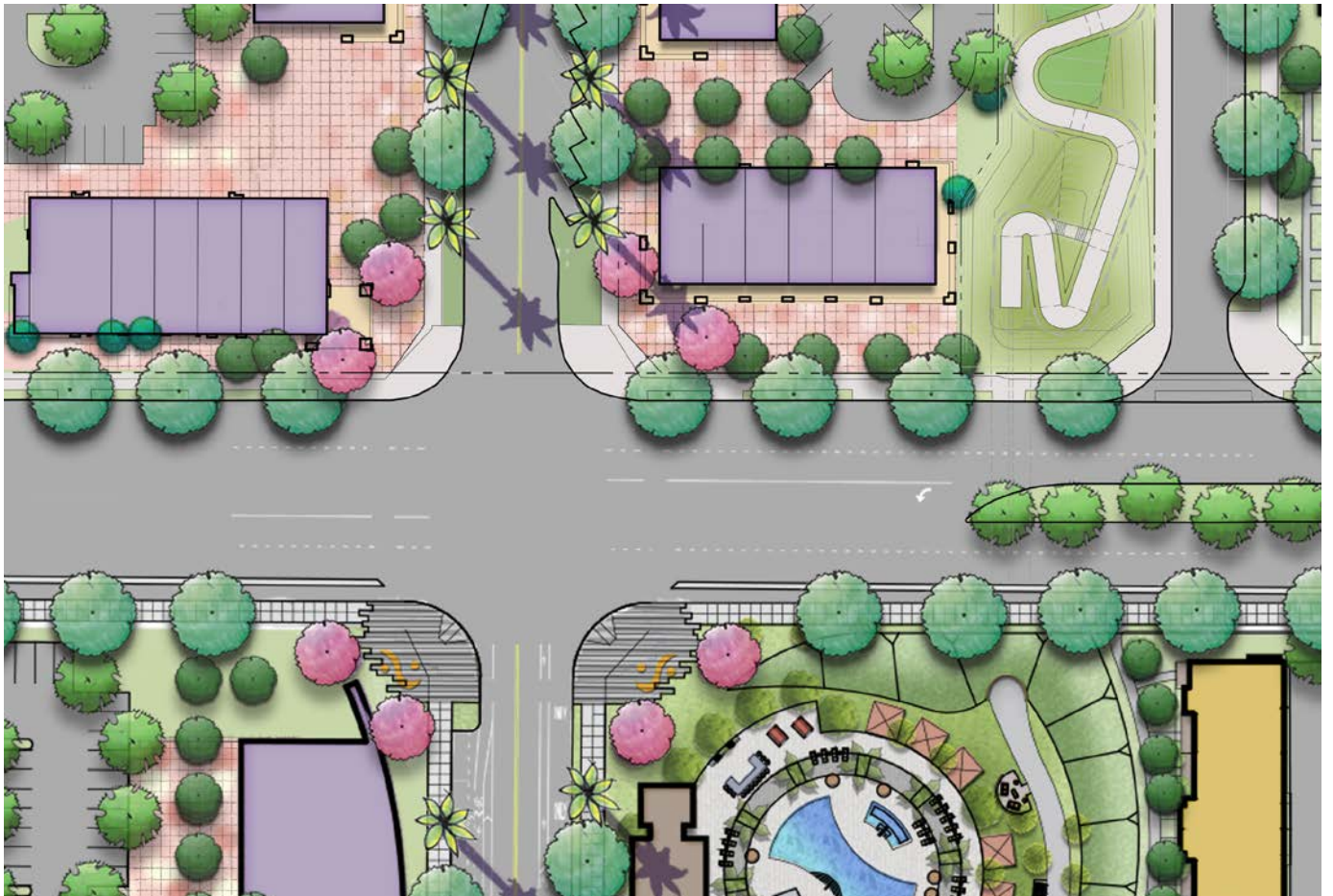

Note: Final design and location of public art at intersections will be subject to approval of the City Traffic Engineer to ensure compliance with sight distance requirements; figure not to scale.

Figure 8.34: 6th Street Intersection



4th Street

4th Street is a public street jointly maintained by the City of Rancho Cucamonga (north half of the street) and the City of Ontario (south half of the street) and includes an on-street bike lane.

4th Street serves as a primary east/west arterial. It defines the southern border of the community and is the main access point to the south end of the community. The streetscape will remain largely consistent with adjacent properties by using existing plant material in the median, if possible, and existing street trees on the south side of the street. The north side of 4th Street will introduce the Vine streetscape concept and theme of the PAIA community. A row of street trees and planter pockets will serve as a buffer between pedestrians and vehicles.

All buildings located adjacent to 4th Street shall have a landscape buffer. Monumentation at the community entry will be provided.

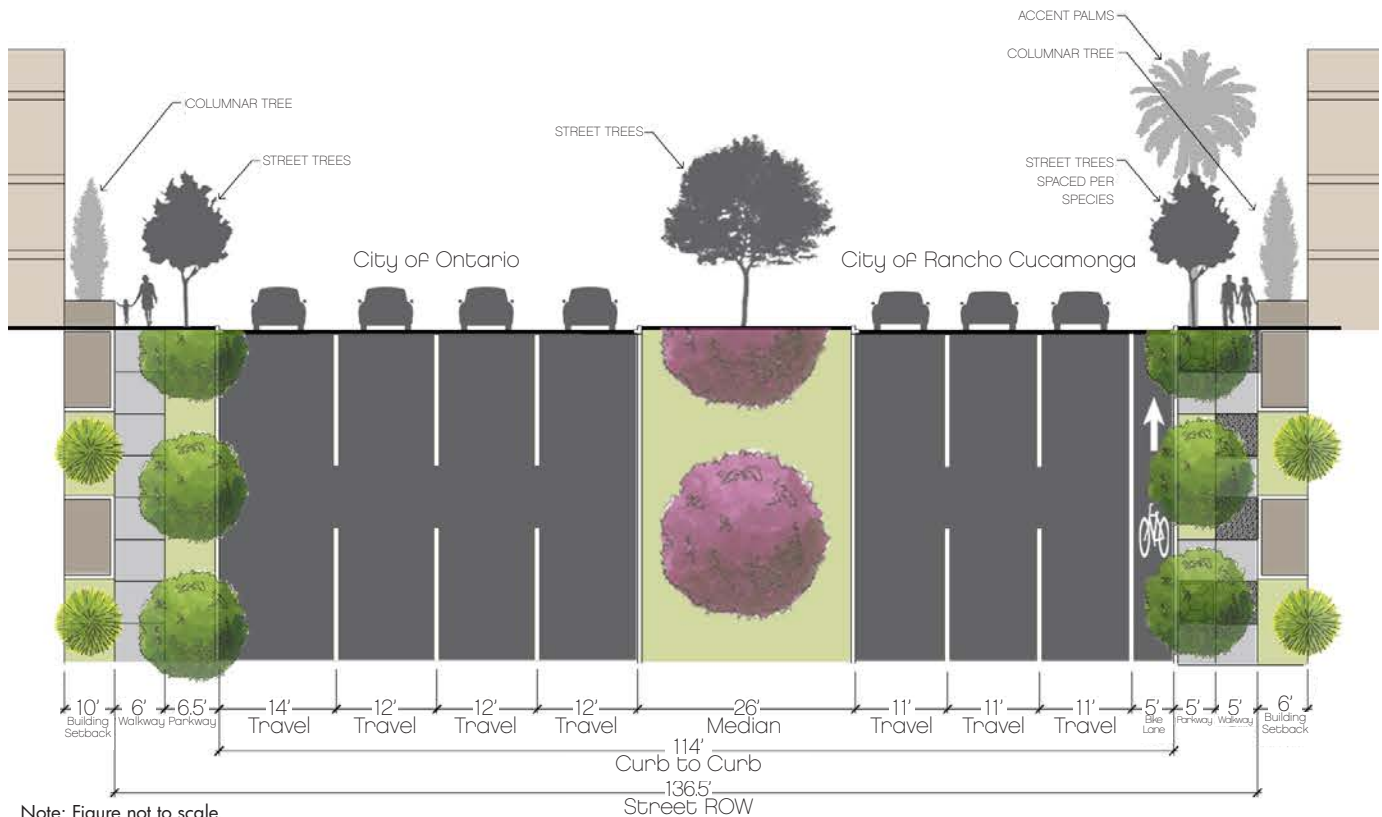

Note: Figure not to scale.

Figure 8.35: 4th Street



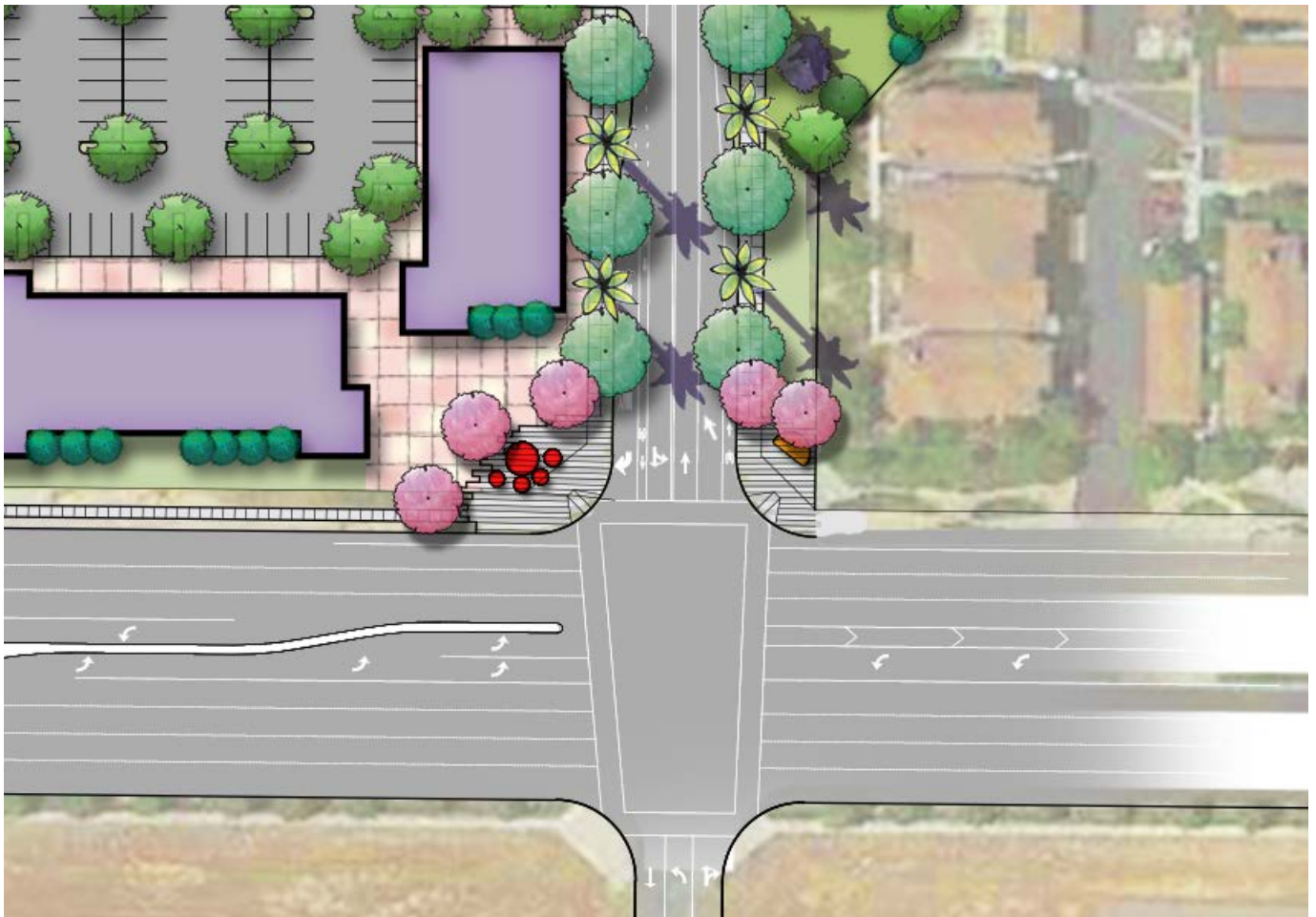

Note: Final design and location of public art at intersections will be subject to approval of the City Traffic Engineer to ensure compliance with sight distance requirements; figure not to scale.

Figure 8.36: 4th Street Intersection

PAGE INTENTIONALLY LEFT BLANK





PAGE INTENTIONALLY LEFT BLANK

PAGE INTENTIONALLY LEFT BLANK



Collector Road

Private residential streets interior to parcels should be narrow and intimate providing on-street parking wherever feasible. The location and alignment of residential streets for interior circulation will be established at the time of development. Parking may be provided, as feasible on one or both sides of the street.

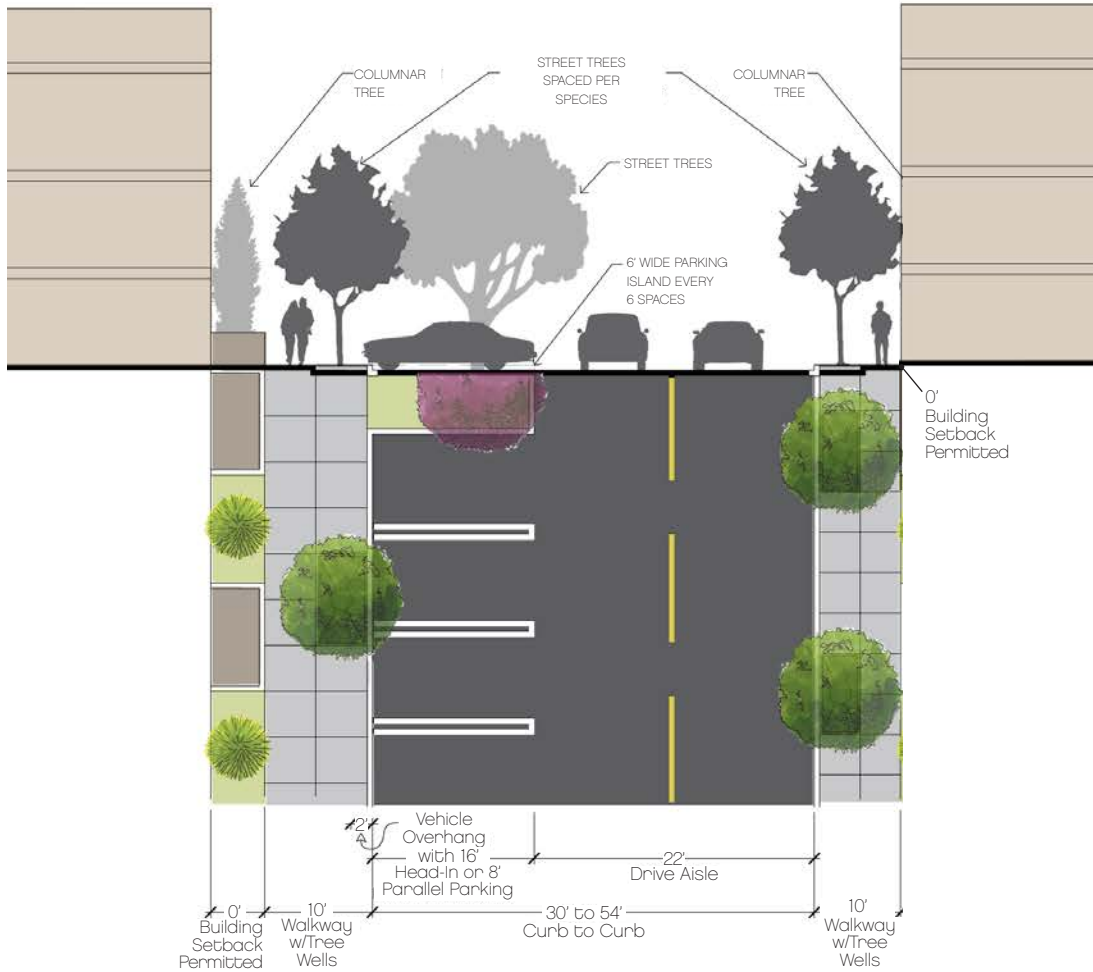

Note: Figure not to scale.

Figure 8.40: Collector Road

Private Drive Aisle

The location and alignment of private residential streets interior to parcels will be established at the time of development. Depending on site planning, location, and intended purpose of the Private Drive Aisle, the eight-foot walkway with tree wells is optional on one or both sides, or may be reduced to less than eight feet. Buildings may front, side, or rear onto a Private Drive Aisle; garages may face the aisle. On-street parking may be provided in parallel or head-in configurations.



Note: Figure not to scale.

Figure 8.41: Private Drive Aisle



Private Drive Aisle at PAI Boundary

Figure 8.35: Private Drive Aisle at PAIA Boundary may be used along the Primary Edge Condition in lieu of Figure 8.15-A: Primary Edge Section and Figure 8.15-B: Residential Edge Section where a pedestrian access edge condition is more appropriate or preferred. Use of this section or a drive aisle along the boundary is not required.

Appropriate for rear or garage conditions; on-street parking is required. A landscape buffer shall be provided between drive aisle/parking and the PAI boundary line.

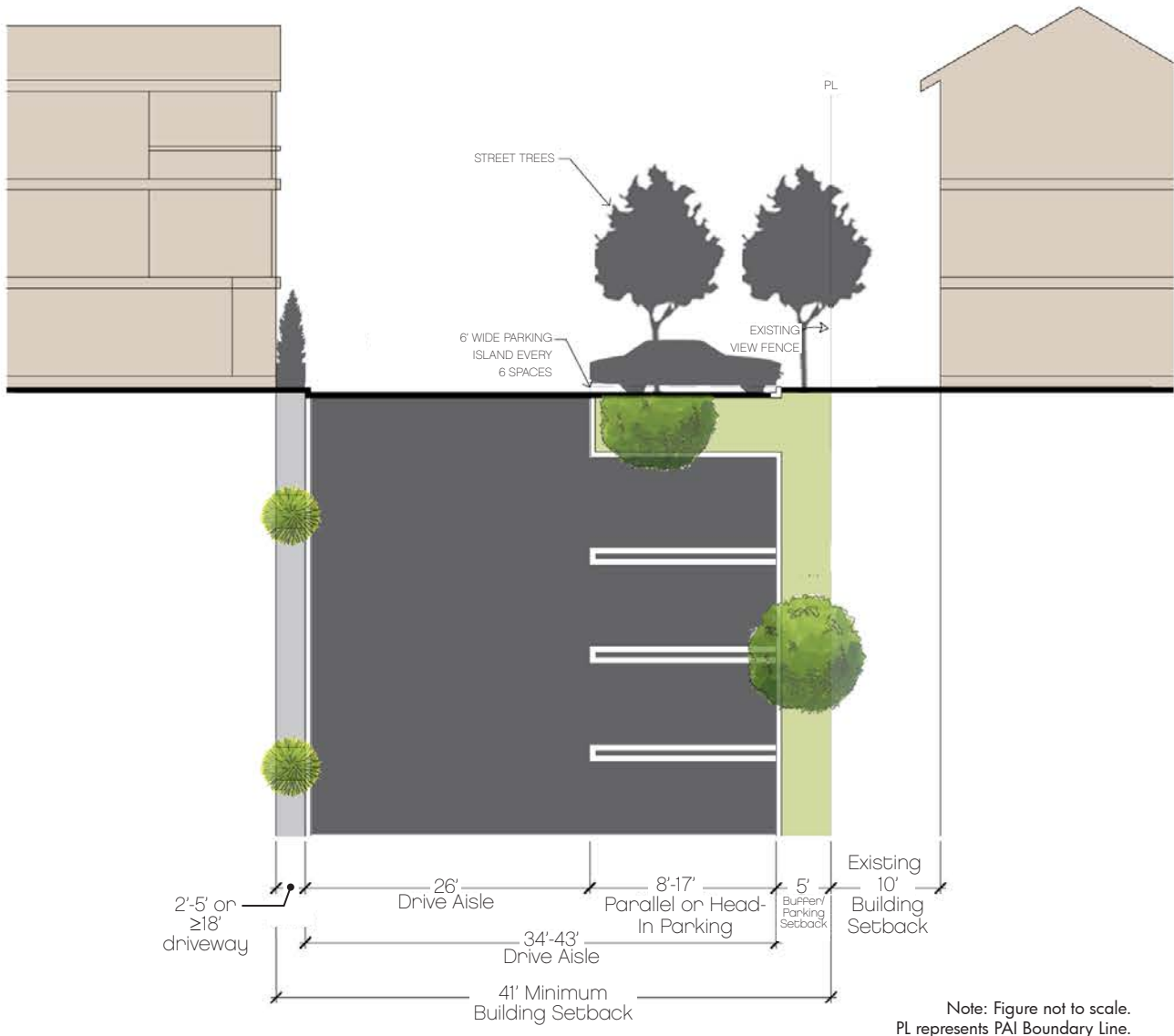
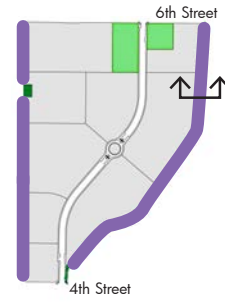
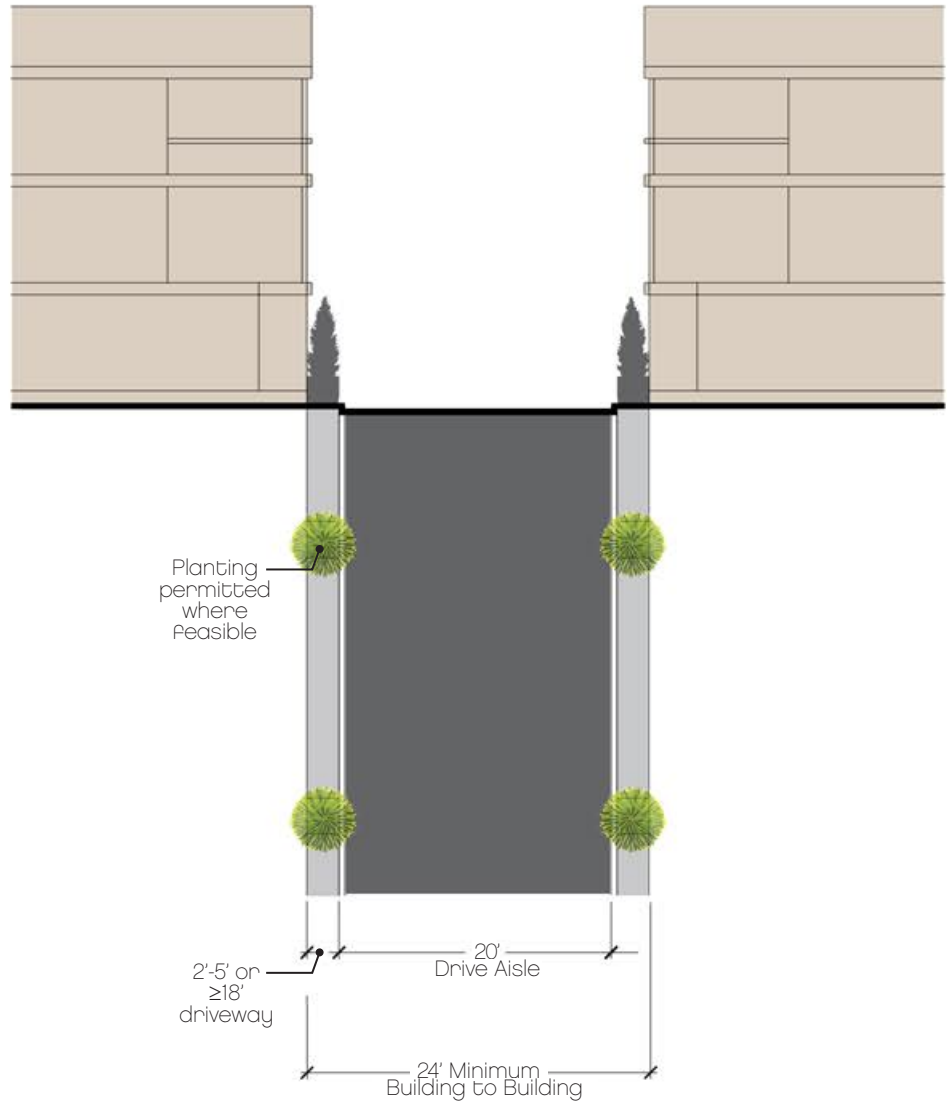

Figure 8.42: Private Drive Aisle at PAI Boundary

Alley

Alleys, as shown on Figure 8.36: Alley Section are private drives used primarily for garage access. Access to front doors, garages, private open space, and pedestrian circulation may all be provided for within Alleys. A minimum 20-foot two-way drive shall be provided for garage/front door access. If Fire Department access is required the Alley will be 26 feet clear.



Note: Figure not to scale.

Figure 8.43: Alley Section



8.4 Architectural Guidelines

These guidelines provide a design framework for parcels and buildings to convey an aesthetically interesting community identity within an urban living environment. The guidelines are intended to be flexible, promoting engaging streetscapes without limiting the product type or configuration of the built environment to allow for the greatest adaptability to market changes.

The built environment shall exhibit design quality, including consideration of articulated entries and facades, proportionate windows, and quality building materials. Additionally, connections to 3rd Place spaces and pedestrian amenities, adequate parking, and context-sensitive elements are encouraged.

The following guidelines have been written to guide builders and architects in creating architecture which is consistent with the envisioned community. While many examples are provided, they do not serve as an exhaustive list of design solutions.



Architectural design may include contemporary, traditional, and interpretive vernaculars



Site planning can create 3rd place spaces

Sketches and graphic representations contained herein are for conceptual purposes only and are to be used as general visual aids in understanding the basic intent of the guidelines. They are not meant to depict any actual lot or building design. In an effort to encourage creativity and innovation, the guidelines express “intent” rather than “absolute,” thereby allowing certain flexibility in fulfilling the intended design goals and objectives.



Building design and location create a strong urban presence with clear pedestrian access points



Interior pedestrian circulation created with plazas and paseos, connecting units to broader multi-modal opportunities

Active Architecture

The variation of building form, wall movement, detailing, entry location or window placement provide human scale and interest along an elevation.

8.4.1 Site Planning Criteria

The following site planning criteria should be treated as design guidelines for parcel site planning and community placemaking.

A. Planning For Active Spaces

- Building massing, design, and setbacks shall reinforce a pedestrian-scale for the street scene without generating unusable pockets or dead spaces.
- Buildings are encouraged to be built to the minimum setback line to create a continuous street edge.
- Buildings should be oriented toward streets, pedestrian pathways and/or active spaces; rear elevations shall not face the Vine, 4th, 6th or 7th Streets. See Figure 8.44: Urban Framework Diagram for example building orientations.
- Where building design undulates, spaces along the pedestrian realm should be large enough to foster visual interest, but not too deep to disrupt the continuity of the street.
- Effectively address neighborhood corners to enhance accessibility to the Vine.
- Buildings should be arranged to create a variety of outdoor spaces including intimate courtyards, urban plazas, community squares, 3rd Place gathering spaces, pedestrian arcades, and/or private and common open spaces.
- Connected pedestrian circulation systems and accompanying plaza and patios, should be an integral part of a unified site design.
- Provide connections at no more than about 400 feet or less intervals or at least one pedestrian connection per block.
 - Front entries should face or be accessible from these spaces, where feasible.
- If non-residential uses are developed under Mixed Use Overlay, enhance the retail experience by introducing architectural elements that create an inviting pedestrian experience such as outdoor dining, public art and/or outdoor retail display.
- Coordination between parcels is encouraged for building scale, massing, architecture, and pedestrian amenities.
- Incorporation of appropriate Crime Prevention Through Environmental Design (CPTED) features in the design of spaces such as territorial reinforcement, strategic natural surveillance, well-lit spaces, and appropriate maintenance.

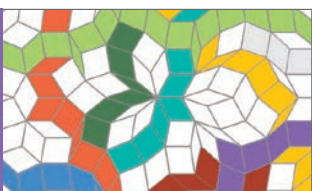

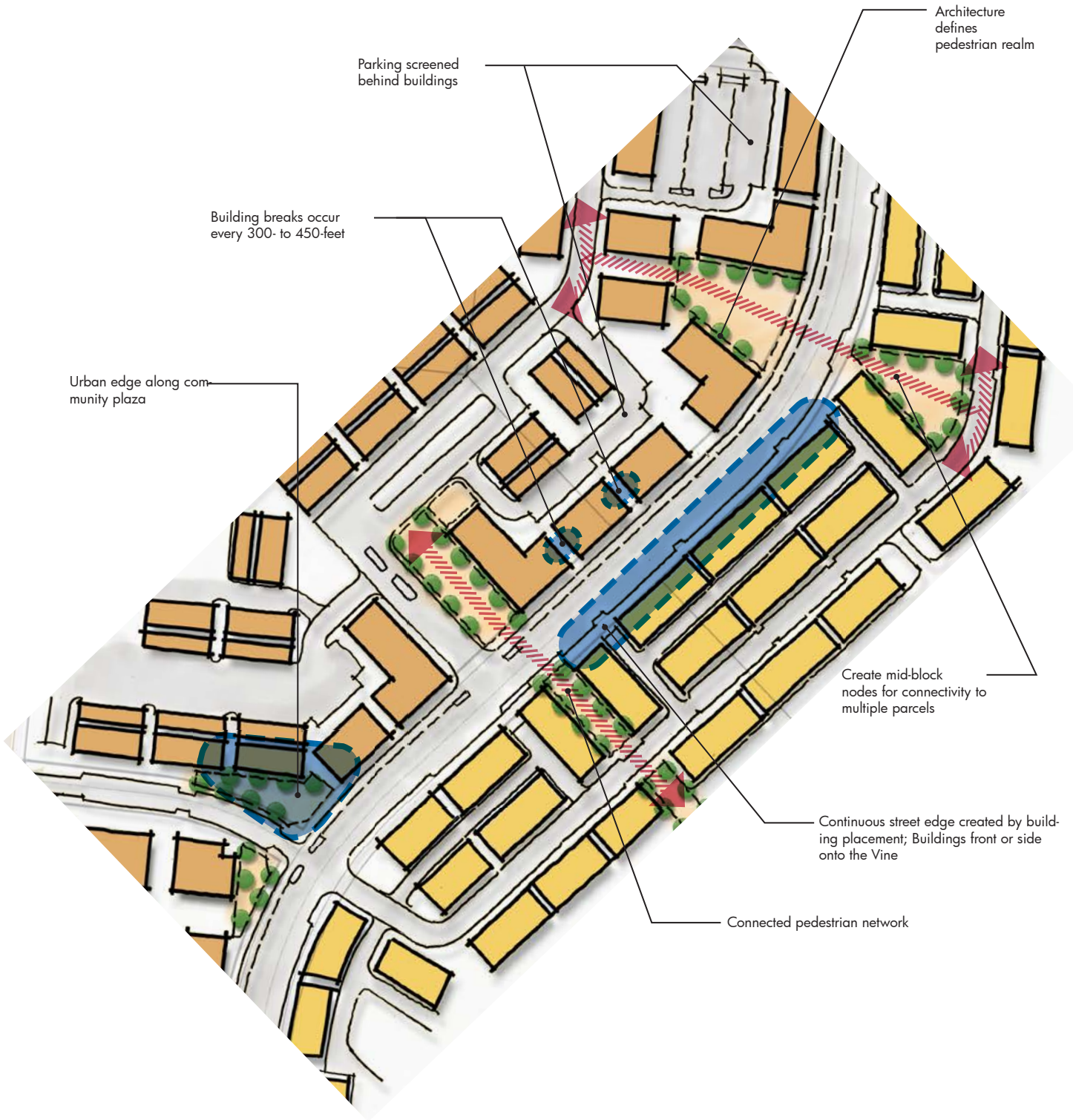

Figure 8.44: Urban Framework Diagram

Note: Figure not to scale.



Tight massing addresses the street



Setback massing, simple wall plane offsets, and height accents create variation consistent with a simple home approach

8.4.2 Scale, Massing, and Articulation

Higher-density, urban-styled communities are primarily defined by the streetscape experience; how the building massing frames the street creates an engaging built form and sense of place. Buildings that create active and inviting urban streets are typically large volume buildings of three or more stories. The scale of higher-density buildings shall be designed for visual interest, creating rhythm and scale to the street. Composition of massing, interlocking volumes, and addition of stylized details will achieve engaged streetscapes. This may mean subtle massing offsets with a higher-level of detail, or bolder forms with more pronounced massing variation and simple to sparse detail. The design approach shall be tailored to the architectural style and context of the primary pedestrian street.

Each neighborhood shall include a collection of varied but complementary forms that create a streetscene that is clear to navigate physically and visually.

In an effort to meet the rising housing demand, affordability by design is an important consideration. Homes that feature simple structural (massing and roof) forms will provide an aesthetically pleasing neighborhood and be economically feasible for the builder and buyer alike.

Smaller homes especially stand to benefit from a simpler, streamlined architectural treatment characterized by stacked massing, simple rooflines, and an acute attention to detail to maximize buildable square footage. Architecture that results in a simplified massing also has positive impacts on the reduction of the building's carbon footprint through resource-efficient design.

A. Vine

Along the Vine, buildings and entries are encouraged to be located as close to the minimum setback line, as feasible. The Vine is intended to be characterized by a pedestrian-friendly experience with buildings creating a strong built environment to frame the street. Along the Vine, the massing shall provide a predominately three-story residential streetscene of different heights creating articulation and points of visual interest. Single-story elements shall be limited to pedestrian-interface spaces and accessory uses; limited use of single-story porches and massing elements are permitted. Non-residential uses are permitted to be single-story.

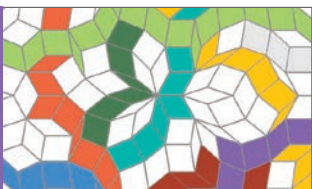

B. Human Scale Design

Buildings should incorporate design and construction methods that add human-scale to the building massing and three dimensional detailing that casts shadows and creates visual interest on the facade.

- Building forms shall be designed and well-proportioned resulting in a balanced composition of elements along public streets.
- The overall design aesthetic (composition of massing, scale, material, color, and detail) is more important than the level of articulation.
- The highest level of design shall occur on the Primary Elevation or Secondary Elevation.
- Selected details cohesive with the Primary Elevation design shall be incorporated into all other building facades appropriately based on the prominence of the elevation.
- All Primary and Secondary Elevations shall have building facades articulated through the use of offset massing elements or volumes, complementary colors and materials, variations in building setbacks, or attractive window fenestrations.

Primary Elevations

Primary Elevations are all elevations directly facing the Vine, 4th, 6th Streets and 7th Streets, and the street connecting the Vine to the Metrolink property. These elevations have the greatest impact on the quality and character of the community. The Primary Elevation may be a front or side facade. Garage doors should not face the Primary Elevation.

Secondary Elevations

Secondary Elevations include all non-Primary Elevations where front entries are located, or the elevations that face a Grand Paseo, 3rd Place space, private ROW, shared amenity, or other key neighborhood feature. The Secondary Elevation may be a front, side, or rear facade; garage doors are permitted along the Secondary Elevation.

Shape and design of balconies slightly modified for each building mass

Different but complementary cornice treatments vary building height and differentiate perceived building massing

Accent entry detail harmonizes elevation

Belt course location and design modified for each building mass



Unified elevation created by utilizing single architectural vernacular with varying detail and window design for each building mass.

- **Height Variation** When a building exceeds 240 feet in length, the elevation height shall visually step in at least one location by a minimum of two feet.
- **Wall Plane Variation** A single wall plane shall not exceed 80 feet in length without a horizontal or vertical wall plane offset of at least one-foot in depth applying to one or more stories.
- Provide pedestrian-scaled massing element such as private courtyards, patios, and entry elements.
- Prominent vertical or horizontal building features may be used to accentuate key elements and provide variation in wall planes.



Use of interlocking volumes with massing changes & use of window design & balcony details creates variation along the streetscape.

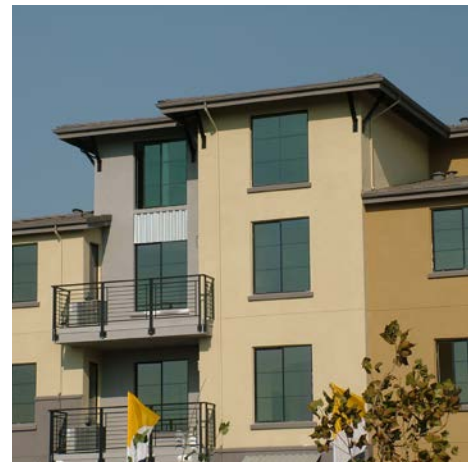

Incorporate window design, roof treatments, details, color & material to enhance simple massing.

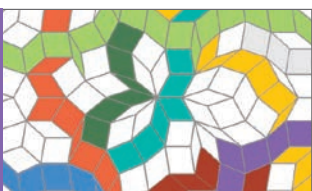

- Projections, overhangs, and recesses should be used to enhance shadow, articulation, and scale of primary edges.
- Massing offsets may consist of one or more of the following:
 - Building pop-outs and recesses (wall planes, massing features, or balconies).
 - Bay window or corner-wrapping window.
 - Prominent entry (encouraged on corner-side elevations).
 - Accent roof.
 - Volume space creating height variation.
 - Single-story element, such as a wrap-around porch, balcony, or courtyard.
 - Other similar features which enhance and provide massing articulation.



Composition of roof forms, projections, and awnings



Figure 8.45: Massing and Articulation Diagram

Horizontal or vertical wall plane break required for wall planes greater than 80 feet in length.



Massing offsets and architectural detailing wrapped to corner and private drive aisle elevation

- Massing offsets shall not encroach into the required horizontal or clear space of a fire access lane and turning radii.
- Entry vestibules or stoops, and architectural design features that provide articulation shall qualify as offsets.
- Blank wall areas visible to the public (without windows, architectural detail, or entrances) are prohibited.
- Architectural elements that create shadow, relief, and sheltered pedestrian areas, such as balconies, trellises, recesses, overhangs, awnings, stoops, and porches are encouraged.
- The main building entry, if applicable, shall be clearly identifiable and distinguished from the rest of the building, preferably a focal point along the elevation in a manner that is consistent with the style of building.



Massing, materials, and glazing activate non-residential corner

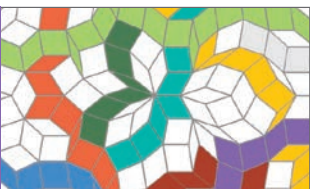

C. Privacy

Privacy is an important consideration in residential and mixed use site planning. Innovative site planning and design techniques should be used to preserve privacy while promoting social opportunities. In particular, windows of units should be located to minimize visual intrusion on neighbors' bedroom windows. Thoughtful and innovative techniques, including landscaping, should be incorporated where appropriate to provide privacy to residents.

8.4.3 Roofs

Roof forms contribute to the overall building design and have a large impact on the mass, scale, and design of the community as viewed from pedestrian spaces.

- Roof design shall incorporate variation in roof forms such as an aesthetic combination of changes in plane, form, ridgelines, and/or heights appropriate to the architectural style.



Examples of private spaces in a variety of configurations.



Variation in parapet height, design, and materials with central common open space



Window design, color scheme and projecting roof element detail this simply-massed building



Varied ridge heights and forms reduce overall scale of building

- Roof forms, material, and fascia elements shall be consistent with the overall design vocabulary of the building and should appear authentic.
- If parapets are used, one or more of the following detail treatments should be included:
 - Pre-cast or simulated pre-cast elements.
 - Contiguous banding or projecting cornice.
 - Dentils.
 - Caps.
 - Corner details.
 - Variety in pitch (sculpted).
- Roof vents should be painted to match or contrast the color of the roof material.
- Fascia design should be complementary to the architectural vernacular.
- Skylights, if used, shall be designed as an integral part of the roof; “bubble” skylights are not permitted. Skylight framing materials should be bronze, anodized or colored to match the adjacent roof materials.

Refer to Section 8.6 Public Safety for additional requirements.

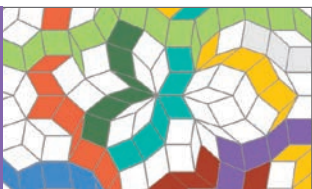

8.4.4 Private Drive Aisle & Alley Treatments

The use of private drive aisles and alleys has evolved from purely functional to a space that residents experience daily, and may include front doors and garage access. Design of these spaces shall address the functional and aesthetic features to create a pleasant experience for residents. At least three of the following shall be implemented along the private drive aisle or alley:

- Massing offsets (layered wall planes, recesses or cantilevers) of at least one-foot.
- Window trim, colors, and selected details from the front elevation.
- Rear privacy walls and pedestrian gates.
- Enhanced garage door patterns or finishes.
- Planting areas between garage doors.
- Variety of garage doors using color or design elements.



Projections, wall plane offsets and recessed garage conditions in alley treatments



Upgraded garage doors, projecting private open space, and color blocking enhance the private drive aisle experience



Architectural detail, including prominent entry statement, contributes to quality design

8.4.5 Architectural Detailing

Architectural detailing of building facades is a key feature of quality design. Special attention is required in the treatment of entries (doors, vestibules, porches or courtyards) using enhanced trim or details to emphasize these as primary focal points. Articulated or unique window treatments can further enhance wall surfaces, provide shade and wind protection, and contribute to the character of the neighborhood.

- Secondary Elevations of attached product that have no rear elevation (such as wrap or podium buildings) should be designed in a way that complements the architectural vernacular of its surroundings.
- All building elements, such as materials and color, detail elements (porches, balconies, courtyards, awnings, surface treatments, and materials), and functional elements (garage door lights, exterior stairs, guardrails, gutters, downspouts, screen walls, electrical enclosures, or similar features) should be integral to the buildings design, consistent with the architectural vernacular of the building, and complement the surrounding neighborhood.
- All accessory structures (including detached garages and carports) should be compatible in design, materials, and color with the primary building(s), and be visually related to the development.

A. Entries

Front entry doors and entryways should:

- Be oriented toward a street, pathway, auto court or 3rd Place gathering space.
- Provide a focal point for each residential unit or the building as a whole.
- Be protected with overhangs, recesses, porches, awnings, trellises or other appropriate architectural element.

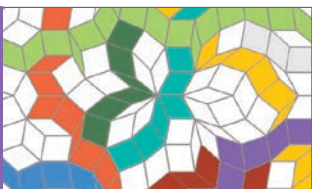

B. Windows

Windows play an important role in the exterior architectural character of the building. Special emphasis should be given to the way windows are used for design effect consistent with the architectural vernacular. See Section 8.4.9 Architectural Styles.

C. Materials

Construct buildings using quality materials to create a community of character and long-term value.

- A variety of materials and textures shall be incorporated within the design theme of the community.
- Heavier building materials, such as brick, stone, tile, and pre-cast concrete, shall be limited to ground level to form the building base and convey a sense of durable, and balanced construction.
- Durable, quality materials designed to appear as an integral part of the design shall be used.
- Material changes should occur at intersecting planes preferably at inside corners of walls or other meaningful locations where architecture elements intersect.
- All ground level materials shall wrap columns and posts in their entirety.



Genuine materials give an appearance of authenticity

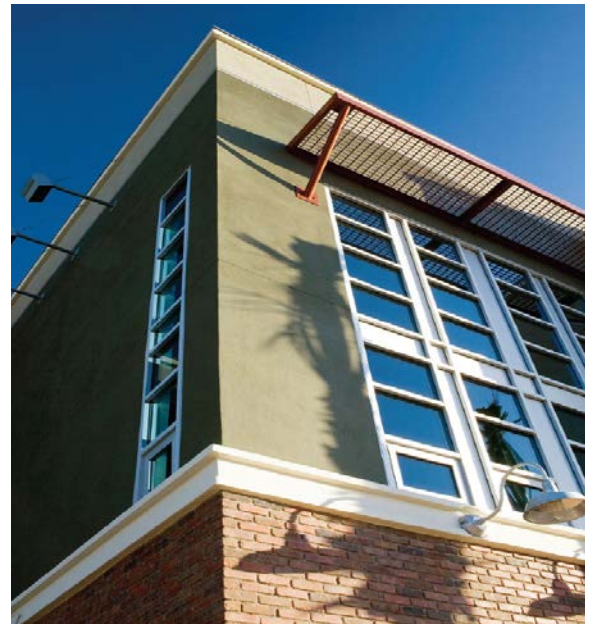

Style-appropriate windows; heavier base material

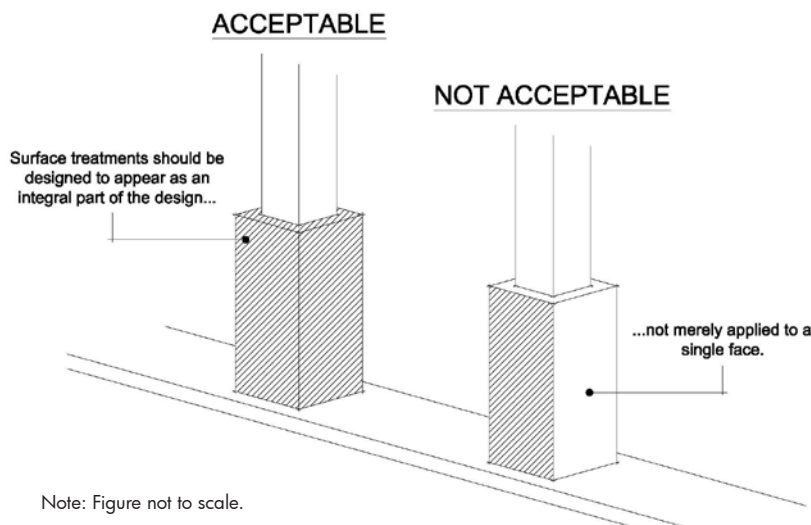

Note: Figure not to scale.

Figure 8.46: Material Wrapping Diagram



Appropriate use of materials reinforces contemporary design theme



Utility cabinets integrated in architecture



Example of functional element treatments

D. Functional Elements

- All roof-mounted equipment should be screened from ground level view through the use of parapets or other effective architectural elements.
- Ground mounted equipment and meters should be visually concealed and designed to not detract from the architecture of a building.
 - Air conditioning units shall be screened by walls or landscaping a minimum of six inches taller than the equipment and located away from project amenities, except when located in courts and lanes with limited or no screening.
 - Where possible, group equipment.
 - Electrical meters should be ganged and located behind doors.
 - Natural gas meters should be grouped.
- Mechanical devices such as exhaust fans, vents, pipes, gutters, and downspouts should be painted to match adjacent surface, or colored to match accent colors.
- Fire Department connections (FDC), sprinkler post indicator valves (PIV), fire hydrants, and standpipes will be installed and screened as required by NFPA 13, 24, and RCFCF Standard 5-10.

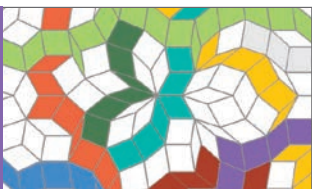

8.4.6 Trash Enclosures

- Refuse and recyclable materials storage areas shall be enclosed consistent with the City’s Development Code.
 - Storage areas that can be overlooked from above should incorporate roof structures to screen the contents of the enclosure from view. Such roof structures should be designed to allow the doors of the refuse container to fully open.
- All refuse/recyclable materials areas, mechanical devices, and utility area screening shall be finished using materials, vocabulary, and details compatible with the surrounding architecture.
- Gates shall be solid metal painted to match adjacent buildings.



Refuse enclosures should reflect the project design

8.4.7 Service and Loading

- Loading and service areas should be located to the side or rear of the building. Screening of these areas shall be provided by the use of walls, decorative fencing, or landscaping limiting views from public streets.
- Incorporate shared loading docks, driveways, and common waste collection areas between adjoining non-residential or mixed use sites to the extent practical.



A bold color palette can create visual interest



A subtle color palette can have lasting appeal

8.4.8 Elevations and Color Application

The plotting of elevations, color, and material palettes should be selected with the design objectives of avoiding monotony, providing depth and interest with a variety of colorful design schemes, and promoting visual diversity along public streets.

- Where one building type is used along a Primary Elevation parcel frontage, the following shall be required:
 - A minimum of two architectural styles.
 - A minimum of two color schemes.
 - Each elevation style shall have a different roof design, unless a flat roof is utilized.
- Each parcel shall have a minimum of two color schemes.
- Colors should complement the architectural style and overall color scheme of the building.
 - Selected finish materials should be appropriate in their use and application, be durable, and of high quality.
- Changes should occur at logical termination points, generally at inside corners. See Figure 8.46: Material Wrapping Diagram.

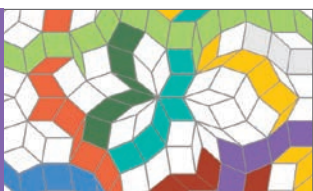

8.4.9 Architectural Styles

The massing, character and detailing of an architectural style should be expressive of and authentic to that style. However, the style guidelines should be applied with flexibility to allow contemporary adaptations of traditional vernaculars.

Architectural styles within the community may include:

Modern Styles:

- Art Deco.
- Contemporary.
- Industrial.

Adaptive Styles:

- Craftsman.
- European Heritage.
- Italian.
- Main Street.
- Monterey.
- Prairie.
- Spanish.

Additional styles may be proposed; however, they must follow the same principles and attention to detail as the specific vernaculars listed here.



Adaptive Prairie elevation



Industrial elevation



Contemporary elevation



Examples of urban elevations

A. Modern Styles

The Modern styles accommodate the more urban setting. These styles are well-suited for high-density residential buildings in mixed use neighborhoods that blend business, industry, and housing.

The Modern styles include simple, unadorned geometric forms detailed with materials, projections, and windows. The styles emphasize interlocking volumes with a collage of materials and colors. Architectural elements such as awnings, balconies and trellises can be appended to the volumes, allowing indoor/outdoor spaces to be created. Vertical and horizontal elements can provide interest to the residential structures. The roofs may be flat with parapets, sloped, or a combination of both.

Urban Elements:

- Plan form is more cubic expressed in bold, simplified forms.
- Roofs are typically shielded by parapets and may have accent roof features such as curves, gables, hips or sheds.
- Wall materials typically consist of stucco, metal, brick, stone and/or siding; it is recommended that design be comprised of two different wall materials.
- Projections to articulate facades are typical and may include building wall planes, awnings, overhangs, canopies, window trim or accent roof forms.
- Braces in conjunction with projections are typical.
- Windows are typically a primary feature of the elevation; design sometimes includes groupings, unique size or shape or oversized and symmetrical mullions.
- Handrails and guardrails enhance the elevations.
- Color blocking is typical.

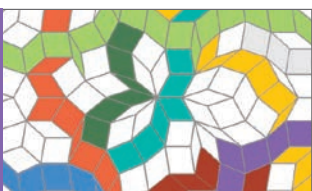

B. Adaptive Styles

Traditional architecture is based on recognizable, authentic and historically derived forms, materials and details that reasonably express a particular style. Adapted or historically derived elevations focus on character-defining elements but allow for the integration of modern materials, colors and artistic interpretation to generate a more contemporary, yet recognizable, expression of a traditional architectural style.

Adapted elevations can incorporate new, modern or progressive forms, details and materials in the modern context of architecture. Architectural liberties are taken in interpretation and design to create an identifiable style that is not strictly historical.

Adaptation Elements:

- Plan form is generally bold and simplified.
- Elevation is generally identifiable as derived from the traditional form, detail, or signature feature reflective of the style from which it is derived (i.e. balcony, brackets under eaves, entry surrounds, bay windows, porches, corbels, columns, and railing).
- Roof pitches may be exaggerated (shallower or steeper).
- Roof overhangs may be exaggerated.
- Wall materials typically consist of stucco, metal, brick, and/or siding; it is recommended that designs be comprised of two different wall materials.
- Wall materials may be modern.
- Windows match the theme of the elevation in detail, size, orientation or trim.
- Details are simpler and highlighted or exaggerated to define style.



Bold, simple form with traditional elements



Modern expression mixing traditional materials with bold contemporary details



Prairie adaptation

Art Deco



The Art Deco style (including Streamline or Art Moderne subsets) was prevalent in America from the mid 1920s to mid 1940s. This style combined elements of Modern Architecture with an integration of decorative arts. There was less emphasis on asymmetrical compositions and on structural purity in favor of pattern of mass and rhythm of openings. Art Deco buildings can feature bold colors, bold geometric and rectilinear shapes, often emphasizing the vertical.

Later in this period came Streamline or Art Moderne influenced by aerodynamic principles of cars, trains, ships and even household appliances. This style has an emphasis on smooth, horizontal lines often accented by curved corner elements whether in solid walls (decorated with tiles or screed lines), windows, or glass block. Thin horizontal canopies, rounded forms, and even porthole windows are typical character-defining elements. The simple massing typology of this style is well-suited for multi-family attached and high-density homes.

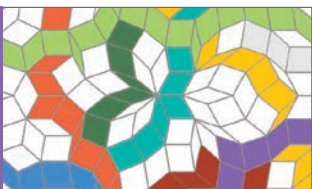



Credit: Designlens.com

Art Deco Style Elements

Elements	Standards*	Enhancements
Roof Components	<ul style="list-style-type: none"> • Flat roof with parapet walls • Roof pitches not applicable • Small ledge coping along top of parapet walls 	<ul style="list-style-type: none"> • Tile or decorative accents along parapet
Roof Materials	<ul style="list-style-type: none"> • Consistent with overall design, as applicable 	
Roof Colors	<ul style="list-style-type: none"> • Consistent with overall design, as applicable 	
Architectural Components	<ul style="list-style-type: none"> • Square and rectangular forms highlighting vertical forms 	<ul style="list-style-type: none"> • Narrow section rectangular steel columns OR round slender steel posts at entries, decks or at shade devices
Wall Materials	<ul style="list-style-type: none"> • Stucco 	
Wall Colors	<ul style="list-style-type: none"> • Neutral to bold colors including whites and tints 	
Trim & Details	<ul style="list-style-type: none"> • Accent colors and/or materials highlighting vertical forms 	<ul style="list-style-type: none"> • Decorative horizontal or vertical grooves, geometric patterns • Stylized motifs as an accent just below the top of the parapet • Belt line running along the wall at a height even with the top of a second story window header
Trim Colors	<ul style="list-style-type: none"> • Contrasting neutral hues 	
Windows	<ul style="list-style-type: none"> • Large single-pane feature windows and corner windows • Secondary vertical windows 	<ul style="list-style-type: none"> • Transom window accents • Horizontal window mullion patterns
Doors	<ul style="list-style-type: none"> • Simple doors 	
Accent Colors	<ul style="list-style-type: none"> • Bold, contemporary accents strategically applied 	

* All of the standard characteristics shall be incorporated into the design of any building using this architectural style. Variations shall be subject to review and approval by the Design Review Committee and the Planning Commission.

Contemporary



The Contemporary style represents the current thinking in design. The style is composed of simple, rectangular geometric forms with generous window areas, accented by bold use of materials and colors and detailed by interesting balcony railings and canopies. Flat roofs are typical but shallow-pitched roofs may also be utilized. Windows and balconies can emphasize

a corner orientation to break open the mass of the building. A combination of bold background colors can distinguish architectural features as will modern exterior materials such as fiber cement siding, panels or metal siding. Windows help articulate the form to create larger organizations, whether in horizontal or vertical compositions.

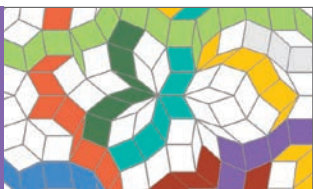

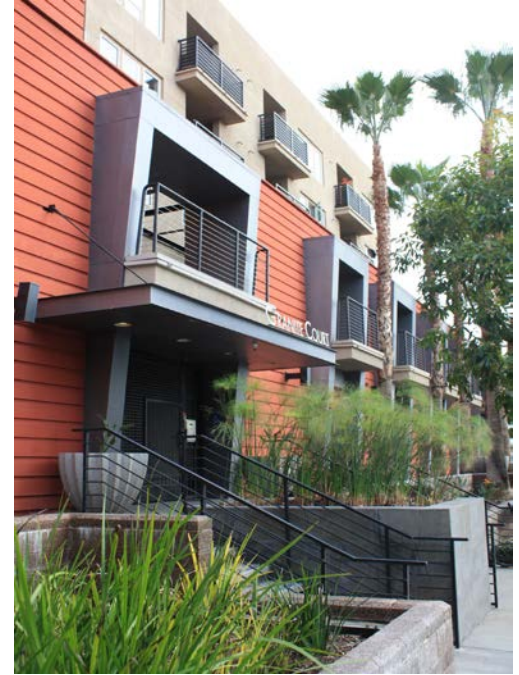

Contemporary Style Elements

Elements	Standards*	Enhancements
Roof Components	<ul style="list-style-type: none"> • Flat roof with parapet or shed roofs • Roof pitches 3:12 to 4:12 where applicable • Simple unadorned parapet walls 	<ul style="list-style-type: none"> • Accent roof element (sloping, hip OR gable, broad extended eaves, etc.) • Gable, hip OR shed forms • Exaggerated accent roof forms
Roof Materials	<ul style="list-style-type: none"> • Consistent with overall design, as applicable 	
Roof Colors	<ul style="list-style-type: none"> • Consistent with overall design, as applicable 	
Architectural Components	<ul style="list-style-type: none"> • Signature form, detail or feature 	<ul style="list-style-type: none"> • Architectural liberties are taken in interpretation & design
Wall Materials	<ul style="list-style-type: none"> • Stucco 	<ul style="list-style-type: none"> • Accents of metal, brick and/OR siding
Wall Colors	<ul style="list-style-type: none"> • Contrasting form and/or material defining colors 	
Trim & Details	<ul style="list-style-type: none"> • Minimal OR exaggerated window trim 	<ul style="list-style-type: none"> • Closed OR exposed eaves
Trim Colors	<ul style="list-style-type: none"> • Contrasting traditional OR contemporary colors 	
Windows	<ul style="list-style-type: none"> • Vertically proportioned, stacked or purposely unbalanced placement 	
Doors	<ul style="list-style-type: none"> • Rectangular, highlighted as primary feature of elevation 	
Accent Colors	<ul style="list-style-type: none"> • Contrasting traditional OR contemporary colors 	

* All of the standard characteristics shall be incorporated into the design of any building using this architectural style. Variations shall be subject to review and approval by the Design Review Committee and the Planning Commission.

Industrial



The Industrial style has evolved from the rehabilitation and re-purposing of older industrial properties into dynamic mixed use buildings and residential loft spaces. The style includes simple and unadorned forms detailed with materials, projections and windows for indoor/outdoor living. The style emphasizes interlocking volumes with a collage of colors and materials. Typically the ground floor volume is larger, giving the appearance of residential built above as an addition to the building.

Architectural elements such as awnings, balconies and trellises can be appended to the volumes, allowing indoor/outdoor spaces to be created. Vertical and horizontal elements provide interest to the residential structures. The roofs may be flat with parapets, sloped or a combination of both. Windows should be placed in areas to overlook common areas and increase surveillance for these areas.

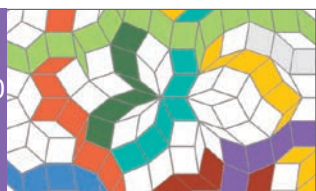



Industrial Style Elements

Elements	Standards*	Enhancements
Roof Components	<ul style="list-style-type: none"> Flat roof with parapet walls Roof pitches not applicable Simple unadorned OR detailed parapet walls 	<ul style="list-style-type: none"> Accent roof features as appropriate Signature towers OR vertical projections can extend above roof line Cantilevered projections Roof decks
Roof Materials Roof Colors	<ul style="list-style-type: none"> Consistent with overall design, as applicable 	
Architectural Components	<ul style="list-style-type: none"> Projections OR wall planes articulate facade Utilitarian and “edgy” Simple, unadorned forms 	<ul style="list-style-type: none"> Projections OR horizontal banding between floors Asymmetrical facade
Wall Materials	<ul style="list-style-type: none"> Stucco, metal OR fiber cement siding Contrasting wall materials and textures 	<ul style="list-style-type: none"> Brick OR stone veneer Metal accents Concrete OR glass
Wall Colors	<ul style="list-style-type: none"> Contrasting form and/or material defining colors 	
Trim & Details	<ul style="list-style-type: none"> Color blocking as appropriate 	<ul style="list-style-type: none"> Metal awnings OR overhangs Metal, cable, glass OR panel balcony railings Sunshades
Trim Colors	<ul style="list-style-type: none"> Contrasting neutral tones 	
Windows	<ul style="list-style-type: none"> Minimal trim Repetitive mullions 	<ul style="list-style-type: none"> Simple industrial dark window trim Larger window modules Long ribbons of windows Nontraditional window shapes and placements
Doors	<ul style="list-style-type: none"> Understated 	<ul style="list-style-type: none"> Roll-up doors Store front
Accent Colors	<ul style="list-style-type: none"> Bold, contemporary hues 	

* All of the standard characteristics shall be incorporated into the design of any building using this architectural style. Variations shall be subject to review and approval by the Design Review Committee and the Planning Commission.

Craftsman



Influenced by the English Arts and Crafts movement of the late 19th century and stylized by California architects such as Bernard Maybeck in Berkeley and the Greene brothers in Pasadena, the Craftsman style stresses the importance of insuring that all exterior and interior elements receive both tasteful and artful attention. Originating in California, Craftsman architecture relies on the simple house tradition, combining hip and gable roof forms with livable porches and broad overhanging eaves.

The wood-working craft defines this style by carefully treating details such as windows and porches. Exposed rafter tails and knee braces below overhanging eaves and rustic-textured building materials are character defining features. Substantial, tapered porch columns with stone piers lend a Greene character while simpler double posts on square brick piers and larger knee braces make a Craftsman distinctly more Maybeck. The overall effect is the creation of a natural, warm and livable home of artful and expressive character.

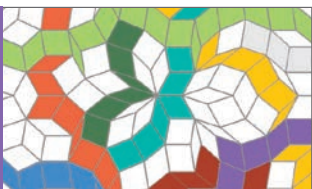



Craftsman Style Elements

Elements	Standards*	Enhancements
Roof Components	<ul style="list-style-type: none"> • Side-to-side gable with cross gables OR combination hip and gable forms OR flat roof with parapet walls • Roof pitches 3.5:12 to 8:12 where applicable • Exposed rafter tails at prominent locations • Bargeboard and rafter tails at gable ends, where used 	<ul style="list-style-type: none"> • Extended eaves at accent features • Shaped rafter tails preferred • Outlookers and brackets
Roof Materials	<ul style="list-style-type: none"> • Flat, shake concrete tile OR asphalt shingles 	
Roof Colors	<ul style="list-style-type: none"> • Medium to dark value browns, greens and earthy red hues 	
Architectural Components	<ul style="list-style-type: none"> • Porch OR covered entry OR defined entry 	<ul style="list-style-type: none"> • Heavy “timber” columns • Post & beams
Wall Materials	<ul style="list-style-type: none"> • Medium sand float stucco finish (16/20) • Horizontal siding 	<ul style="list-style-type: none"> • Shingle siding OR board & batten OR brick OR stone accents
Wall Colors	<ul style="list-style-type: none"> • Medium light to medium dark value earth-related tones of brown, rust, olive green and ochre 	
Trim & Details	<ul style="list-style-type: none"> • Appropriately sized columns (where used) 	<ul style="list-style-type: none"> • Gable end details • Tapered OR double-post porch columns on brick OR stone piers • Shutters • Pot shelves
Trim Colors	<ul style="list-style-type: none"> • Toned whites in light to medium light value range and brown shades in medium to dark value range 	
Windows	<ul style="list-style-type: none"> • Vertically proportioned windows • Window grids • Fully trimmed windows 	<ul style="list-style-type: none"> • Grouped windows with continuous head trim • Vertical windows at first floor • Horizontal windows at 2nd floor along belt course
Doors	<ul style="list-style-type: none"> • Paneled front entry doors • Paneled garage doors 	<ul style="list-style-type: none"> • Front entry wood and glass doors • Garage doors with windows
Accent Colors	<ul style="list-style-type: none"> • Earthy, warm hues, medium to dark value, including green, rust and burgundy tones 	

* All of the standard characteristics shall be incorporated into the design of any building using this architectural style. Variations shall be subject to review and approval by the Design Review Committee and the Planning Commission.

European Heritage



Many “traditional” American styles have been heavily influenced by European designs, emulated and adapted in a variety of expressive elevations. This European Heritage collection emerged from the stylization of simpler English and French building traditions that came to America in the first European colonial settlements and were revived by European architects for wealthy Americans.

In contrast to grander Tuscan and Italian styles that were adapted from the classical public building and church architecture of the time, the interpretation of traditional French or English styles has resulted in uniquely American expressions. All of these styles typically include steeper roof pitches, straightforward framing with simple forms, use of stone and brick veneers and tower elements meant to highlight the building entry.





European Heritage Style Elements

Elements	Standards*	Enhancements
Roof Components	<ul style="list-style-type: none"> Main roof hip OR gable with intersecting gable roofs OR flat roof with parapet OR mansards Roof pitches 6:12 to 12:12 where applicable Gable end OR parapet details French & English: tight rakes American: standard rakes 	<ul style="list-style-type: none"> American: Dormers French & English: Curved slope at roofline
Roof Materials	<ul style="list-style-type: none"> Flat concrete slate tile 	
Roof Colors	<ul style="list-style-type: none"> Cool tones of natural slate 	
Architectural Components	<ul style="list-style-type: none"> Porch OR covered OR defined entries 	<ul style="list-style-type: none"> Traditional pediment at entry Tower element Bay windows
Wall Materials	<ul style="list-style-type: none"> Medium sand float stucco finish (16/20) 	<ul style="list-style-type: none"> American: Siding accents (horizontal OR vertical) French & English: Stone OR brick accents
Wall Colors	<ul style="list-style-type: none"> Medium light to medium value subdued hues of taupe, warm gray, yellow and green and warm-toned whites 	
Trim & Details	<ul style="list-style-type: none"> Appropriately sized and minimally detailed columns 	<ul style="list-style-type: none"> Metal details American: Fully trimmed windows with projecting sills French & English: Plank shutters Details to create a thick wall look
Trim Colors	<ul style="list-style-type: none"> Warm tones of gray, blue-gray, brown and gray-green in medium to dark value 	
Windows	<ul style="list-style-type: none"> Window grids on all upper levels 	<ul style="list-style-type: none"> Dormer windows Window grids on all windows
Doors	<ul style="list-style-type: none"> Paneled front entry doors Paneled garage door with windows 	
Accent Colors	<ul style="list-style-type: none"> Muted shades of blue, green, gray and red in medium to medium dark value 	

* All of the standard characteristics shall be incorporated into the design of any building using this architectural style. Variations shall be subject to review and approval by the Design Review Committee and the Planning Commission.

Italian



The Italian style is a good example of a transplanted style developed in a climate zone similar to the Southern California climate. In the 1860s, the Italian Villa was one of the fashionable architectural styles in the United States based on the formal and symmetrical palaces of the Italian Renaissance. Italian homes are straightforward and boxy, with only window crowns and cornice moldings as ornamentation.

This old world prototype has been refined, adapted and embellished into a truly eclectic classic style. The shallow pitched hipped roof, often with decorative

brackets, identifies this style. As it became a popular building material, wrought iron expanded the Italian style vocabulary to include a variety of embellished designs for porches, balconies, railings and fences.

An off-shoot of this style, Italianate, emerged in the row houses of San Francisco with amplified Italian Renaissance characteristics including the emphasis on use of classic Roman orders in columns, decorative motives along the exaggerated cornice line and projecting bay windows under hip roofs.

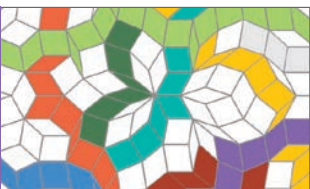

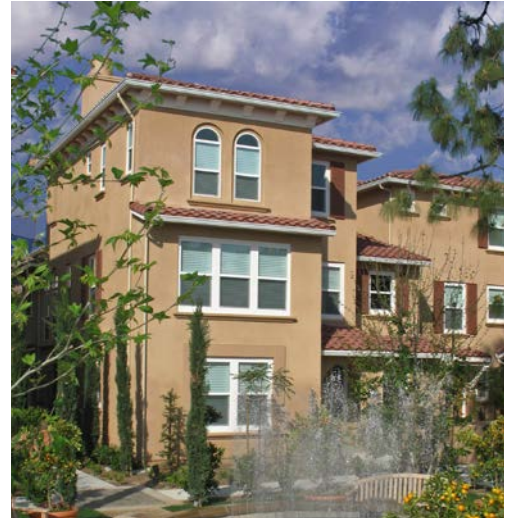

Italian Style Elements

Elements	Standards*	Enhancements
Roof Components	<ul style="list-style-type: none"> Main hip roof with hip ancillary roofs OR flat roof with parapets or mansards and cornice elements Roof pitches 3.5:12 to 5:12 where applicable 	<ul style="list-style-type: none"> Closed/shaped eave with corbels at accent elements
Roof Materials	<ul style="list-style-type: none"> "S" concrete tile 	<ul style="list-style-type: none"> Barrel tile
Roof Colors	<ul style="list-style-type: none"> Hues of terra cotta OR other natural clay roof tile colors 	
Architectural Components	<ul style="list-style-type: none"> Precast surrounds 	<ul style="list-style-type: none"> Medallions
Wall Materials	<ul style="list-style-type: none"> Medium sand float stucco finish (16/20) 	<ul style="list-style-type: none"> Brick OR stone accents
Wall Colors	<ul style="list-style-type: none"> Medium to medium dark value saturated colors in earth tones, especially yellow, orange and red 	
Trim & Details	<ul style="list-style-type: none"> Window and door trim Horizontal belt course 	<ul style="list-style-type: none"> Formal entry with smooth stucco trim Cast stone surrounds, precast trim Simulated precast columns at entry OR between windows Base trim
Trim Colors	<ul style="list-style-type: none"> Wood trim in medium dark to dark value browns; precast concrete trim in medium light value, warm toned whites 	
Windows	<ul style="list-style-type: none"> Arched, round top, OR pedimented accent windows at selected locations Symmetrically ordered and stacked windows and openings 	<ul style="list-style-type: none"> Paneled OR louvered shutters on accent window Grid patterned at front and visible windows Recessed windows
Doors	<ul style="list-style-type: none"> Entries detailed with precast surround feature Paneled front entry doors Paneled garage doors 	<ul style="list-style-type: none"> Garage doors with windows
Accent Colors	<ul style="list-style-type: none"> Vibrant shades of medium dark to dark value blues, greens, oranges and reds 	

* All of the standard characteristics shall be incorporated into the design of any building using this architectural style. Variations shall be subject to review and approval by the Design Review Committee and the Planning Commission.

Main Street



In the 19th century typical Main Street architecture was built as a single building or in groups of buildings with party walls. Brick store fronts could extend up to a block in length. These buildings varied in height from one to three or more stories. In urban settings, this style was often occupied by a business on the ground floor and offices, apartments or owner's residence above. Typically the building had a tripartite organization

of base, middle and top. Entrances were located on- or off-center. The lower level was dominated by large windows framed by the building's corners and the panel of brick between floors. The upper levels sometimes included single or double bay windows, brick friezes, panels and decorative cornices. Other options include the use of corniced parapets, continuous sills or decorative lintels and string or belt courses dividing the wall laterally. The cornice functioned as a cap under which other elements were arranged and balanced.

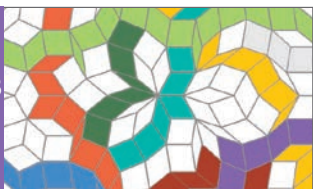



Main Street Style Elements

Elements	Standards*	Enhancements
Roof Components	<ul style="list-style-type: none"> Flat roof with parapet Roof pitches not applicable Accent roof forms OR projecting awnings encouraged 	<ul style="list-style-type: none"> Decorative cornice detail that unified the facade OR provides variety
Roof Materials	<ul style="list-style-type: none"> Consistent with overall design 	
Roof Colors	<ul style="list-style-type: none"> Consistent with or accenting overall design 	
Architectural Components	<ul style="list-style-type: none"> Simple box, multi-story 'storefront' form with accent elements at entries Recessed doorways, tower elements OR applied architectural accents at entries Tripartite organization of base middle and top through use of horizontal belt course, change in material or massing offset 	<ul style="list-style-type: none"> Multiple building heights created by varied parapets and cornice design Balconies Colonnade Raised stoop Horizontal modulation of about 25'
Wall Materials	<ul style="list-style-type: none"> Stucco with accent materials (siding, brick veneer, metal, scored stucco in accent color, etc.) 	
Wall Colors	<ul style="list-style-type: none"> Neutral and accented colors appropriate to the materials used 	
Trim & Details	<ul style="list-style-type: none"> Awning OR projecting feature accenting overall design 	<ul style="list-style-type: none"> Features borrowed from traditional American main streets, appropriate to scale and massing of building
Trim Colors	<ul style="list-style-type: none"> Neutral hues may blend or contrast per context 	
Windows	<ul style="list-style-type: none"> Vertical, may be single OR multi-paned on upper stories, often grouped Large single-paned OR vertical multi-paned on ground floor 	<ul style="list-style-type: none"> Projecting OR angled awnings at any level Pedimented windows at ground level Transoms
Doors	<ul style="list-style-type: none"> Monumented with massing, architectural, OR awnings - design consistent with overall theme 	
Accent Colors	<ul style="list-style-type: none"> Contrasting neutral or bold tones as appropriate 	

* All of the standard characteristics shall be incorporated into the design of any building using this architectural style. Variations shall be subject to review and approval by the Design Review Committee and the Planning Commission.

Monterey



Influenced by both Spanish Colonial and New England Colonial homes, historical Colonial Monterey features Spanish detailing while maintaining the Colonial style form. With its stucco or masonry walls, red barrel, "S" or flat concrete shake roofs, this style exhibits many of the same elements as an historical Spanish home: simple building form and mass, rusticated corbels, head trim, posts or balconies, and gable roof forms. Traditionally the style included horizontal siding on upper floors and the use of wood railings.

Interpretations of this style maintain a simple elegance. The early prototypes added many refinements and new details. Though usually thought to be fully adorned with porches, second floor balconies and verandas, many successful, historical adaptations of this style avoided these details and focused simply on careful massing, detail and the natural beauty inspired through its blend of rich Spanish and Colonial heritage.

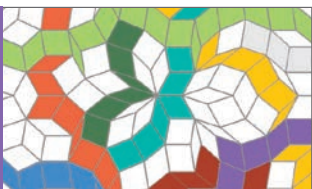



Monterey Style Elements

Elements	Standards*	Enhancements
Roof Components	<ul style="list-style-type: none"> Simple roofs of hips OR gables OR flat roof with parapet walls Roof pitches 4:12 to 5:12 where applicable 	<ul style="list-style-type: none"> Parapets with barrel tile cap Rafter tails, shaped tails preferred
Roof Materials	<ul style="list-style-type: none"> Concrete "S" tile OR flat concrete shake tile OR asphalt shingles 	
Roof Colors	<ul style="list-style-type: none"> "S" tile in hues of terra cotta OR other natural clay colors Shake tile in natural wood tones 	
Architectural Components	<ul style="list-style-type: none"> Balconies cantilevered OR supported Simple wood beams at balcony 	
Wall Materials	<ul style="list-style-type: none"> Medium sand float stucco finish (16/20) Material change at second floor, typical 	<ul style="list-style-type: none"> Brick OR slump block on first floor at main entrance Board and battens OR horizontal siding at upper level
Wall Colors	<ul style="list-style-type: none"> Light to medium value warm colors and toned whites 	
Trim & Details	<ul style="list-style-type: none"> Stucco-wrapped, high density foam trim with fine sand float stucco finish (20/30) OR smooth manufactured foam trim Closed OR exposed eaves Plank-style shutters on feature windows 	<ul style="list-style-type: none"> Well-placed and proportional entry light fixture Wood (or simulated wood products) OR metal railing
Trim Colors	<ul style="list-style-type: none"> Medium to dark value browns reminiscent of stained woods OR toned whites 	
Windows	<ul style="list-style-type: none"> Vertically proportioned windows with simple minimal trim Typically rectangular, arches discouraged 	
Doors	<ul style="list-style-type: none"> Rectangular openings, with simulated precast surrounds OR header 	
Accent Colors	<ul style="list-style-type: none"> Muted tones of medium to dark value blue, green, rust OR burgundy and dark browns 	

* All of the standard characteristics shall be incorporated into the design of any building using this architectural style. Variations shall be subject to review and approval by the Design Review Committee and the Planning Commission.

Prairie



The roots of Prairie architecture began in the late 1800s with the “Oak Park” and “River Forest” houses of Frank Lloyd Wright. The Prairie School of architecture came to California with its own unique interpretation. The style is characterized by horizontal expressions and proportions. Horizontal proportions provide an “earthy” feel while the lower pitched roof often seems to float with its deep overhangs over banded windows. Porte cocheres or raised porches extend out from the entry of the house as a typical feature of this style.

This first purely American style included new decorative motifs and details. The Prairie style in its vernacular form spread throughout the Midwest and to California and New York, along with Wright’s belief that a building should fulfill its primary function, but also exude character, life, spirit, beauty and a vibrant environment.

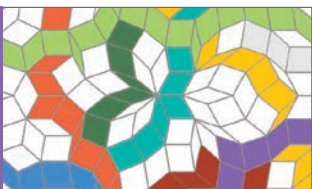



Prairie Style Elements

Elements	Standards*	Enhancements
Roof Components	<ul style="list-style-type: none"> Hip roof typical OR flat roof with parapet walls Roof pitches 3:12 to 4:12 where applicable 	<ul style="list-style-type: none"> Wider overhangs (24") at prominent locations
Roof Materials	<ul style="list-style-type: none"> Flat concrete slate tile 	
Roof Colors	<ul style="list-style-type: none"> Warm, earthy colors including reds, oranges, greens and browns 	
Architectural Components	<ul style="list-style-type: none"> Strong massing OR design features that accentuate horizontal Porches OR stoop entries 	
Wall Materials	<ul style="list-style-type: none"> Medium sand float stucco finish (16/20) Horizontal siding OR brick accents 	<ul style="list-style-type: none"> Brick base accents
Wall Colors	<ul style="list-style-type: none"> Warm colors in light to medium value range 	
Trim & Details	<ul style="list-style-type: none"> Horizontal belt course Appropriately scaled columns 	<ul style="list-style-type: none"> Gable end details Tapered OR double-post porch columns on brick piers
Trim Colors	<ul style="list-style-type: none"> Medium dark to dark value range warm colors or toned whites 	
Windows	<ul style="list-style-type: none"> Banded or grouped windows Vertically proportioned windows 	<ul style="list-style-type: none"> Strong unifying head OR sill on grouped windows
Doors	<ul style="list-style-type: none"> Paneled front entry door Paneled garage door 	<ul style="list-style-type: none"> Garage door with windows
Accent Colors	<ul style="list-style-type: none"> Earthy, medium to dark value range colors including greens, oranges, reds and browns 	

* All of the standard characteristics shall be incorporated into the design of any building using this architectural style. Variations shall be subject to review and approval by the Design Review Committee and the Planning Commission.

Spanish



The Spanish style attained wide-spread popularity after the Panama-California exposition of 1915 in San Diego. The Spanish style's most notable characteristics include the use of "S" or barrel tile roofs, stucco walls, feature entry doors and porticos, highlighted ornamental iron work and carefully proportioned recessed windows appropriate to its wall mass.

Key features of this style are adaptable to buildings both grand and humble. Plans were informally organized around a courtyard with the front elevation very simply articulated and detailed. The charm of this style lies in the directness, adaptability and contrast of materials and textures.

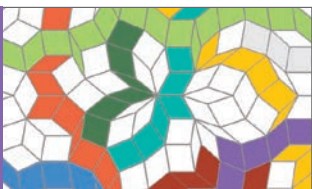



Spanish Style Elements

Elements	Standards*	Enhancements
Roof Components	<ul style="list-style-type: none"> Hip OR gable roofs OR flat roof with parapet walls Roof pitches 3.5:12 to 5:12 where applicable Tight rake, where used 	<ul style="list-style-type: none"> Parapets with barrel tile caps Rafter tails, shaped tails preferred
Roof Materials	<ul style="list-style-type: none"> Concrete "S" tile 	<ul style="list-style-type: none"> Barrel tile
Roof Colors	<ul style="list-style-type: none"> Hues of terra cotta OR other natural clay colors 	
Architectural Components	<ul style="list-style-type: none"> Round top OR arched primary window OR architectural feature Recessed openings at front entry OR porch 	<ul style="list-style-type: none"> Shed roof accent feature Porches, balconies OR verandas
Wall Materials	<ul style="list-style-type: none"> Medium sand float stucco finish (16/20) 	<ul style="list-style-type: none"> Decorative ceramic tile OR brick accents
Wall Colors	<ul style="list-style-type: none"> Toned whites and light to medium light value warm colors 	
Trim & Details	<ul style="list-style-type: none"> Stucco-wrapped, high density foam trim with fine sand float stucco finish (20/30) OR smooth manufactured foam trim Gable end tile details Decorative metal elements (pot shelf, gate, balcony, etc.) 	<ul style="list-style-type: none"> Closed OR exposed eaves Wood beam accents, especially at porch Wall mounted light fixtures at garage door Well-placed and proportional entry light fixtures
Trim Colors	<ul style="list-style-type: none"> Medium dark value browns reminiscent of stained wood 	
Windows	<ul style="list-style-type: none"> Vertically proportioned windows Recessed feature windows 	<ul style="list-style-type: none"> Divided lights Round top windows
Doors	<ul style="list-style-type: none"> Front entry doors without a porch, deeply recessed from front facade Rectangular OR arched surrounds (following door design) 	
Accent Colors	<ul style="list-style-type: none"> Clear to muted blues, greens, rust and burgundy in medium to dark value range OR dark browns 	

* All of the standard characteristics shall be incorporated into the design of any building using this architectural style. Variations shall be subject to review and approval by the Design Review Committee and the Planning Commission.



Inspirational landscape design

8.5 Landscape Design

The urban nature of this community encourages a distinct landscape character with a creative and unique landscape aesthetic. Streets will be designed to be enjoyable, walkable, and interactive to pedestrians. Interior streetscapes shall be designed to provide a cohesive and hierarchal element tying the community together as a whole. Wall treatments will be made more apparent and distinct with decorative pilasters accentuated by selected accent trees and plants for visual impact. Trees shall be strategically located so as not to interfere with driving visibility.

In urban planting schemes, it is critical to achieve contrast between plant species. The contrast can be in color (green to red), form (spiky to hedged), texture (lacy to static), or color value (dark to light). The eye must be able to easily see the difference in the shrub massing. A 'squint test' shall be utilized as a guide for the landscape design. If you can 'squint' and still definitely see the different shrub masses, then the planting scheme has enough contrast.

The landscape design goals include:

- Create a community that motivates, educates, and inspires residents and visitors and furthers their sense of community.
- Encourage residents to explore the physical nature and social fabric of the community.

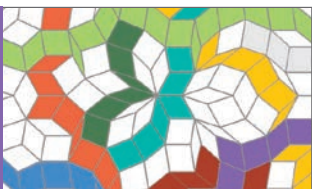

The following policies implement this goal:

- Foster a healthy outdoor lifestyle that considers both physical and spiritual health in the manner that it is designed.
- Design for the user at the smallest neighborhood level and grow in scale outward into the community.
- Promote a sense of arrival that one has just entered somewhere special.
- Bolster a sense of intrigue, surprise, and discovery in 3rd Place spaces that provide opportunities for social interaction, active play, and passive recreation.
- Announce the community’s presence and identity with unique features and landscape treatments.
- Celebrate the community’s heritage and/or historically significant features within its landscape.
- Provide well-thought-out and sensitive community edges.
- Recognize that trees are “a valuable resource” that over time will have an increasingly positive impact when planned properly.
- Design horticulturally compatible landscape in its setting while striving to be environmentally sensitive.
- Include site features, such as bicycle racks, recycling bins, planters, and benches as an integral part of the design.

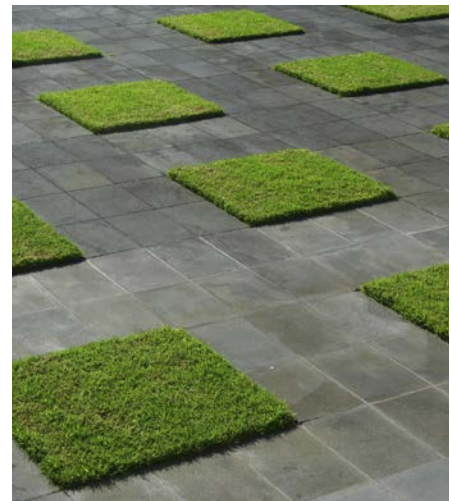
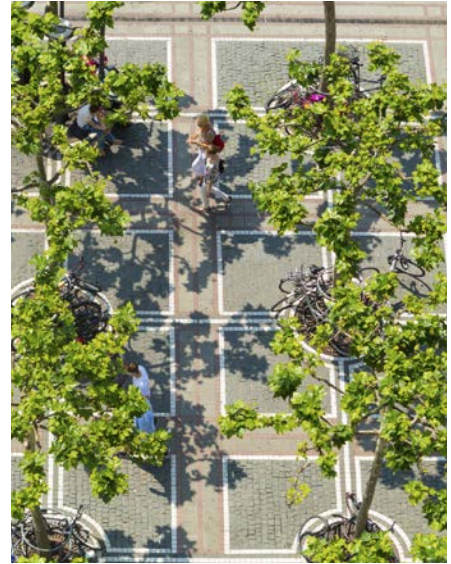

8.5.1 Landscape Placemaking

Landscape design should be used as a strong placemaking element to promote the aesthetic character value of the community by defining, unifying, and enhancing the pedestrian realm. The following features further define the elements and spaces of the pedestrian circulation network described in Section 8.3.6.D Pedestrian Circulation.

These guidelines provide design guidance relating to the overall character of the community to create a strong, cohesive identity. Use and repetition of consistent design concepts, practices, and details will reinforce the distinct character of various features with a native or regionally-adapted planting palette suitable to the climatic and soil conditions of the area. See Table B-1 : Permitted Streetscape Tree List and Table B-2: Permitted Plant List in Appendix B Plant Palette for permitted streetscape and community plant list.

Note: Where a box size is notated herein, box size shall be dependent on a maintenance agreement if required by the City prior to planting.

A. The Vine

The Vine system is a designed network of landscaped pathways connecting 3rd Place spaces, and recreation areas. The following concepts shall be included in the Vine:

- Minimum 11-foot multi-use sidewalk located alongside each side of the street providing a pleasing landscape, dotted with an assortment of trees, a variety of shrubs, and groundcovers creating a sensory, walk-through experience.
- A variety of canopy trees strategically located to provide a “shade oasis” at specific intervals and seating node locations to add comfort for pedestrians.
- Trees should be selected and placed to create a canopy effect to help calm traffic.
- Small gathering spaces to encourage opportunities for social interaction among neighbors and promote a healthy community.
- Signage easily visible and harmonious with the community theme design.



Figure 8.47: Conceptual Vine 3rd Place Space Plaza Rendering

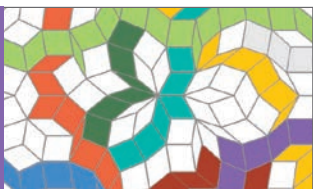

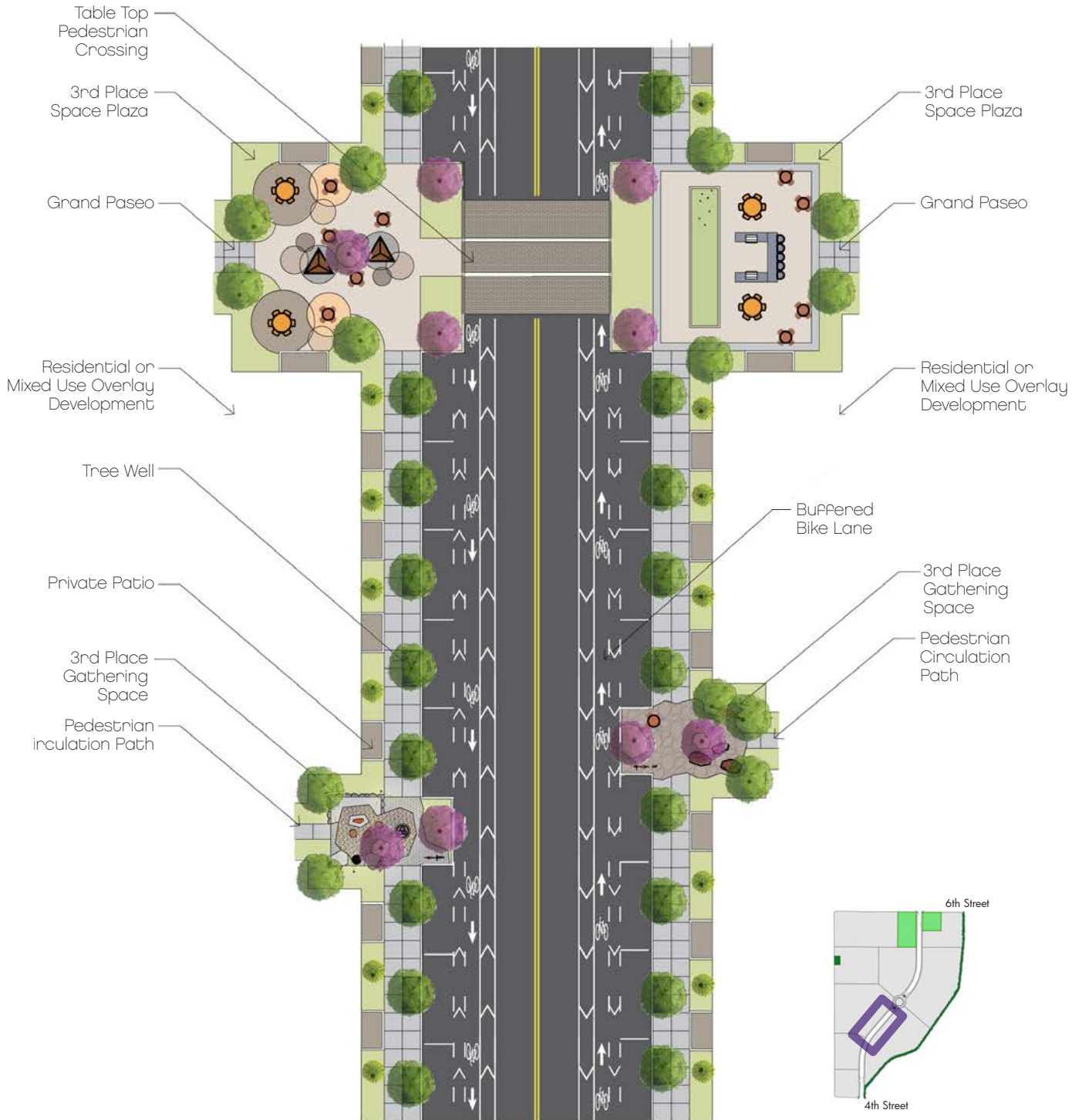

Note: Figure not to scale.

Figure 8.48: Conceptual Vine

PAGE INTENTIONALLY LEFT BLANK

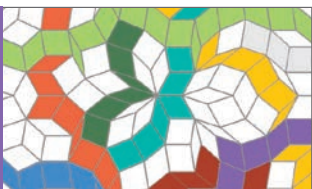



PAGE INTENTIONALLY LEFT BLANK



C. 3rd Place Spaces

3rd Place spaces form a connective network of pedestrian amenities that tie neighborhoods together by creating unique spaces throughout the community. 3rd Places include three types of unique connective spaces:

1. Grand Paseos
2. Pathways
3. Gathering spaces (such as bark parks and pocket parks)

3rd Places should encourage socialization and physical activity by providing both active and passive activities within a cohesive network of open space.



- 3rd Places shall be designed large enough to be usable, intimate, and safe, however not so large as to appear empty or barren.
- Architectural treatments and features are encouraged to connect these spaces to the built environment.
- Provide pathways that link 3rd Place spaces.
- Create event areas within some of the 3rd Place spaces that can host community activities.

Each 3rd Place space will be individually designed to suit the contextual neighborhood, market segment, and social niche; physical and technical details of each space will be addressed during final design and subject to City approval.



Grand Paseos

Grand Paseos enhance social interaction by connecting neighborhoods directly to the Vine. See Figure 8.50: Conceptual Grand Paseo.

Grand Paseo minimum design elements:

- Maintain a minimum width of 30 feet between buildings; private open space features may encroach to a maximum of five feet on one side.
- A urban walking path with a minimum width of eight feet.

3rd Place spaces provide a variety of active and passive outdoor living amenities

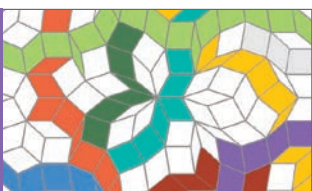

- A double row of shade canopy trees (36-inch box spaced appropriate for species) along both sides of the urban walk.
- Bike racks at logical locations, or where neighborhood pathways connect with the Grand Paseo.
- Dog bag/waste stations as appropriate.
- Landscape lighting.
- Wayfinding signage and location information at each entry/connection to the Grand Paseo.
- A focal element, such as art, fountain, signature tree with seating where the Grand Paseo is intersected by a secondary paseo.
- Decorative paving accents.



Focal art element example.

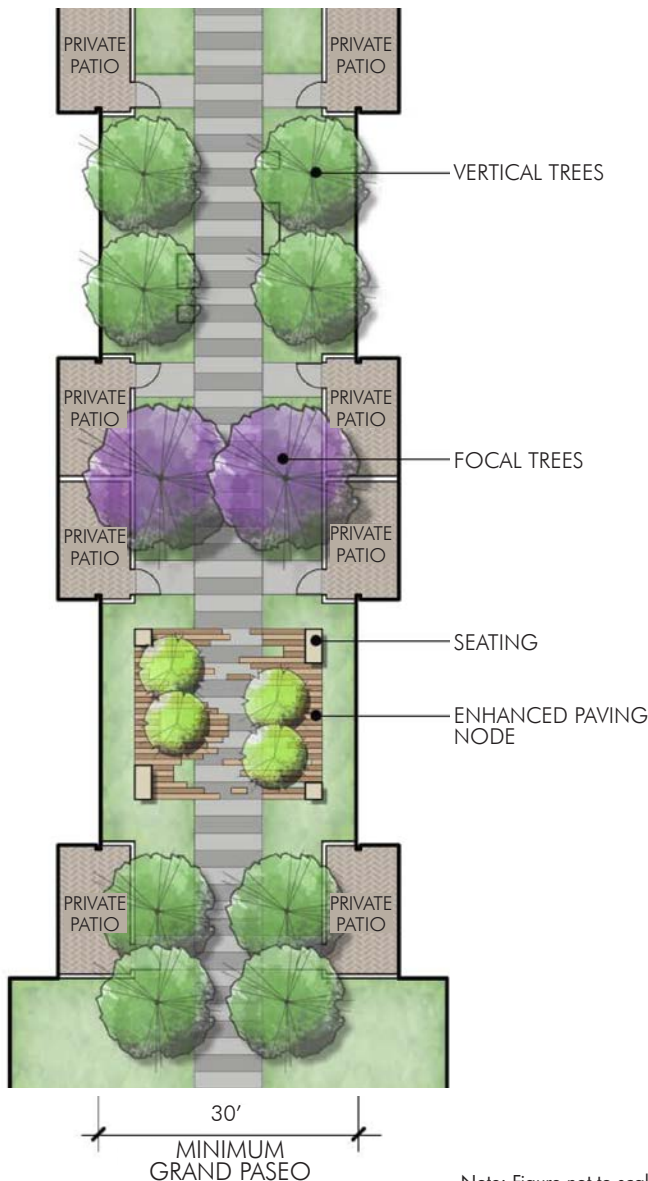

Note: Figure not to scale.

Figure 8.50: Conceptual Grand Paseo

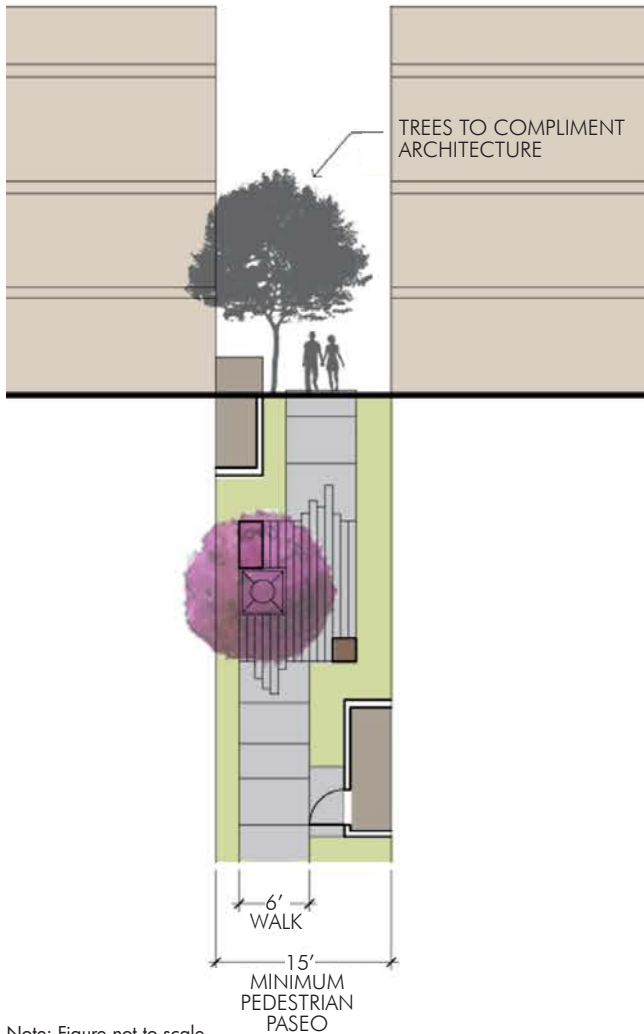

Note: Figure not to scale.

Figure 8.51: Pathway Diagram

Pathways

Pathways provide connections interior to neighborhoods supporting a robust pedestrian network. Pathways are a smaller scale version of the Grand Paseos. Pathways may link up with Grand Paseos, and shall provide connections from neighborhoods to open space, pocket parks, community recreation amenities, and the Vine. Thematic furniture, shade amenities, and planting should support the community theme. Where possible, provide spaces for resting at regular intervals to enhance the pedestrian experience for users of all ages and abilities. See Figure 8.51: Pathway Diagram for additional landscape and amenity requirements.

Minimum design elements:

- A minimum width of 15 feet between buildings; private open space features may encroach to a maximum of three feet on one side.
- A walkway with a minimum width of six feet.
- A mix of shade canopy trees (24-inch box spaced appropriate for species) undulating on each side of the walkway.
- Landscape lighting in a minimal amount; primarily the lighting will be porch or front door lights to provide soft elegance.
- Decorative paving accents.



Inspirational pathway images

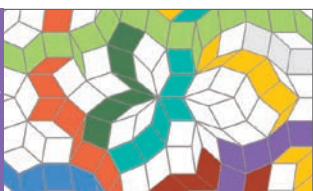

Pathways: Pedestrian Connection(s) to Adjacent Property

To enhance pedestrian circulation in the community and the area, pedestrian pathways are encouraged to connect to adjacent properties. A space and pedestrian access similar to Figure 8.52: Pedestrian Connection to Adjacent Property should be provided where pedestrian connections are arranged with adjacent property owners

Minimum design elements:

- A mix of shade canopy trees (24-inch box spaced appropriate for species) undulating on each side of the walkway.
- Landscape lighting in a minimal amount; primarily the lighting will be porch or front door lights to provide soft elegance.
- Decorative paving accents.



Note: Figure not to scale.

Figure 8.52: Pedestrian Connection to Adjacent Property

Gathering Spaces

Gathering spaces provide unexpected social opportunities within the neighborhoods, or along the Grand Paseos or pathways. These may be bark parks, urban farming areas, expanded plazas, pocket parks, or celebration spaces that dot the pedestrian network and provide comfortable places for rest, social meetups, or highlighted activities. Refer to Figure 8.53: Conceptual Gathering Space for an example of a gathering space.

Gathering spaces should be designed to provide a sense of arrival, be scaled appropriate to the environment, and have a unique character—all while being flexible enough to allow a variety of functions to occur within.

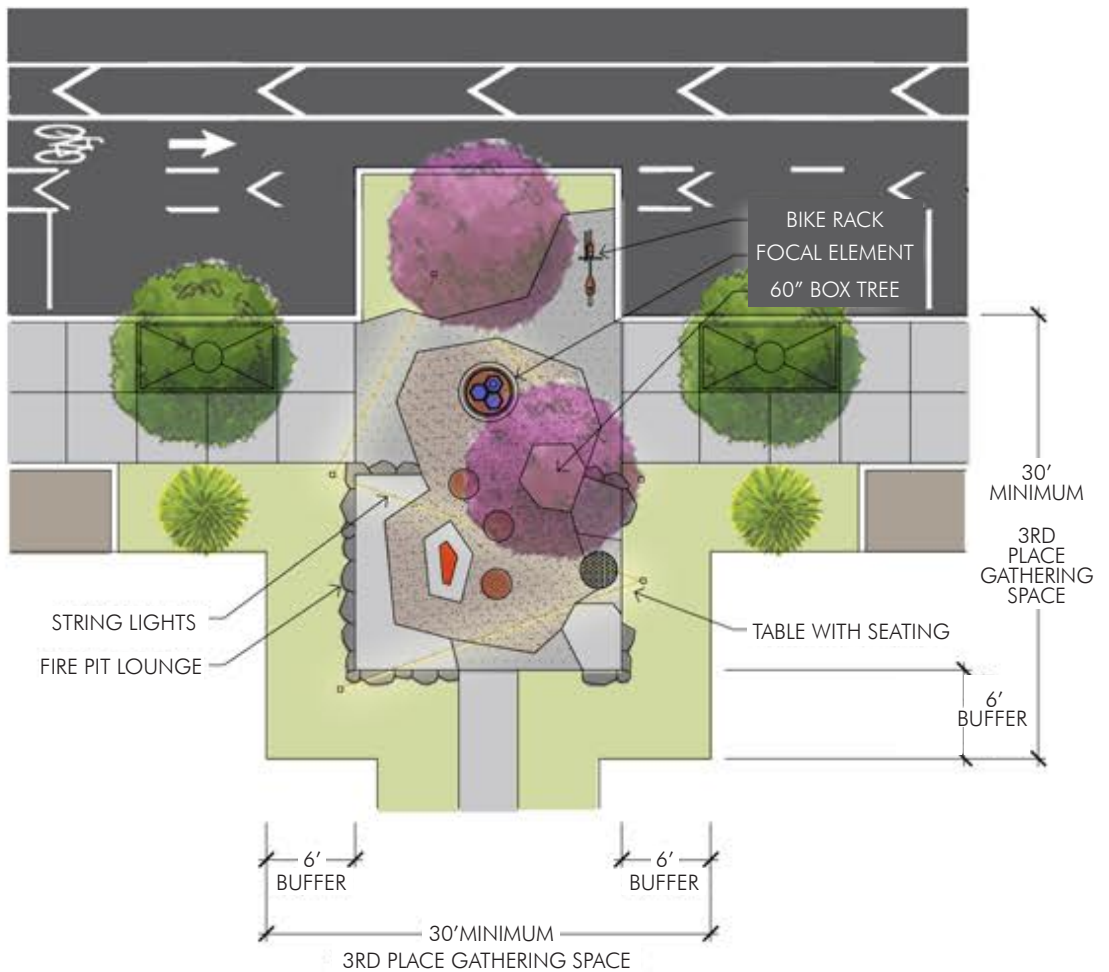

Note: Figure not to scale.

Figure 8.53: Conceptual Gathering Space

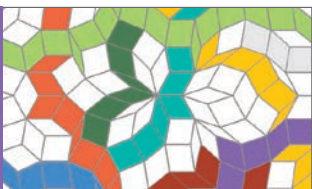

Minimum Gathering Space design elements:

- Minimum size of 900 SF measured building to building or other built feature.
- Define the space through the design and orientation of surrounding buildings.
- One focal 60-inch box tree, OR four 48-inch box trees to define the space and provide shade.
- One focal element, such as art, fountain, or signature tree with seating.
- Landscape lighting.
- Public art is encouraged in order to add a sense of culture and emotion to the surrounding environment. Ideally, art shall be 'linked' emotionally and/or physically with the space, such as a 'bone bench' art piece in the bark park.

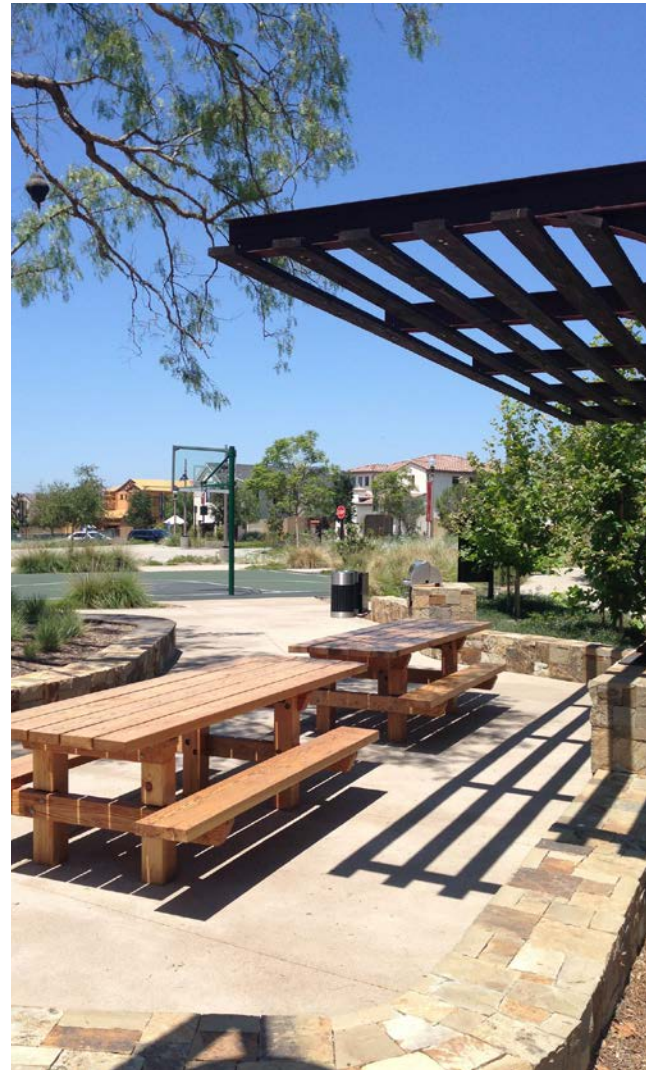

Gathering places may be designed as a range of urban, passive, and active spaces to suit the context and neighborhood



Example of a 3rd Place Space defined by building location and amenitized with walls, landscape, and seating



Gathering Space: Bark Park

Urban dog parks have become a daily gathering and social activity space for dogs and their owners. To build community interaction and spirit, dog parks shall be incorporated in the community.

Minimum design elements:

- Table or bench seating.
- Dog bag/waste stations, provided as appropriate for the size of the space.
- Shade structure or planting to cool space and provide shade.
- One art piece to promote community character.

Recommended features or design elements:

- Wash station/hose area for cleanup.
- Water fountains (for people and dogs).
- Mix of decorative paving, turf or substitute material, and other ground materials to define spaces and create an enjoyable setting.
- Dog activity structures or features.

Art pieces and dog activity structure/features can be usable art, such as bone benches, dog fire hydrants, or dog exercise equipment.

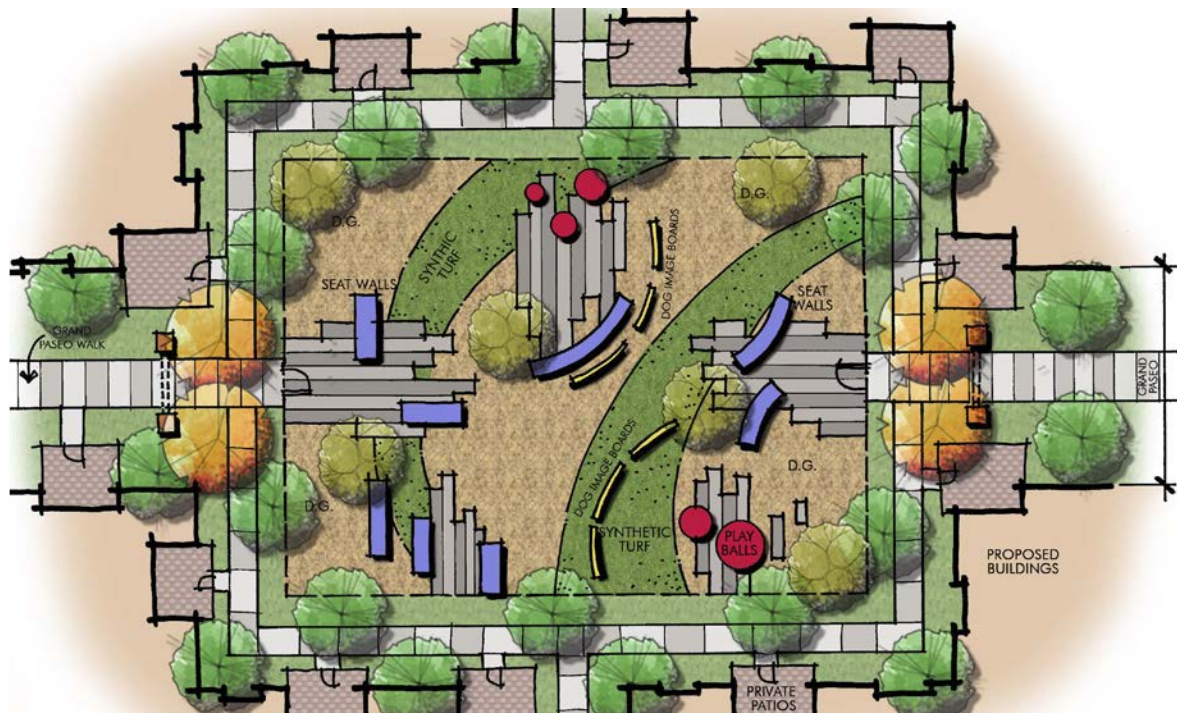

Note: Figure not to scale.

Figure 8.54: Conceptual Bark Park

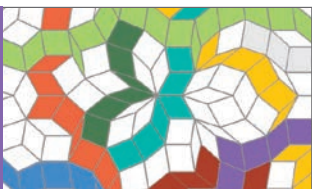

Gathering Space: Urban Farming

The community may support and encourage on-site urban farming. Urban farms may be located in areas that maximize their benefit to the community and encourage use. Urban farm sites should:

- Have adequate solar exposure.
- Be designed to strengthen the character of the community.
- Contain a storage barn, seating with shade, and water access.



Inspirational urban farming examples



8.5.2 Landscape Guidelines

A. Plant Selection

Plant selection enhances the community character and provides contrast between the planning areas. The plant selection shall:

- Emphasize the planting of shade trees in formal and informal groupings throughout the community.
- Use non-invasive drought tolerant plant materials that are climate-appropriate where applicable.
- Consider service lines, traffic safety sight line requirements, and structures on adjacent properties to avoid conflicts both at the time of planting and as trees and shrubs mature.
- Select and install street trees and trees planted near walkways or street curbs to prevent damage to sidewalks, curbs, gutters, and other improvements. Use root barriers where appropriate.
- Encourage use of decorative gravel, decomposed granite, boulders, and similar materials as a texture and design element; size material suitable to remain in place after installation.
- Separate publicly-maintained areas with a walkway, curb, or mow strip when adjacent to private property.
- Reduce water use, as feasible, through the use of drought-tolerant plants, mulch, installation of drip irrigation systems, minimization of impervious areas, and the design of landscaped areas to retain irrigation water.

See Table B-1: Permitted Streetscape Tree List and Table B-2: Permitted Plant List in Appendix B Plant Palette for permitted streetscape and community plant list.

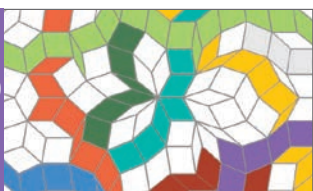

Turf Guidelines

- Restrict use of turf grass to active use areas.
- Use ground covers and drought-tolerant grasses that require less water in non-active areas.
- Size turf areas to optimize irrigation efficiency.
- Select turf type and location in the same manner as other planters.
- All turf shall be on separate irrigation zones.
- Turf is prohibited:
 - On slopes greater than 4:1.
 - Within the ROW, unless designed as an active space.

Irrigation

Irrigation for public and private landscapes should be designed to be water-efficient, water-wise, and utilize the existing reclaimed water system. All irrigation systems shall be designed to properly water plant materials given the site's climate, sun exposure, and soil conditions. The following is a list of appropriate irrigation system design features:

- Automatic irrigation infrastructure shall be permanently provided in all landscaped areas.
- Use drip irrigation where appropriate.
- A no-turf community is acceptable.
- Use automatic and private reclaimed irrigation systems for all public areas and right-of-ways that are compatible with reclaimed water systems.
- Use a weather-based master irrigation controller system that employs current satellite weather data and a rain shut-off device to ensure that the irrigation schedule is based upon actual "real time" plant needs.
- Use of point-irrigation (drip) systems where appropriate to allocate more efficient delivery of water to root systems and minimize run-off.
- Prohibit overhead spray heads in small non-turf applications.
- Use low volume (gpm) matched-precipitation spray heads only where necessary.



Use mixed materials and planting for water responsible design



- Irrigate turf areas with equipment that has a precipitation rate of one-inch or less per hour as specified by the manufacturer. Stream rotator heads are preferred; use of standard spray heads shall be avoided.
- Achieve an irrigation operational distribution uniformity of 70% or greater in all turf areas and 80% in all other landscaped areas.
- Use reclaimed water in all private and public open space areas where feasible.
- Design irrigation system based upon solar exposure where feasible.
- Provide additional support irrigation system for all major tree groupings by providing water to each individual tree utilizing a flush grade bubbler system on a separate valve in order to more efficiently manage water demand.



Acceptable Plant Materials

The planting concept for neighborhoods, urban, and commercial portion of the plan should be consistent with community concept. See Appendix B Plant Palette for an approved community plant palette.



Examples of non-turf landscape planting

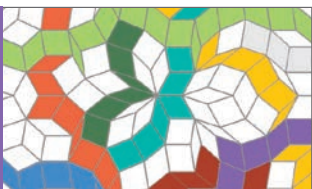

B. Streetscapes

Streetscapes shall include:

- Appropriately sized (minimum size of 24-inch box) street trees with large canopies and/or skyline presence are encouraged to promote community identity and a sense of arrival.
- Root barriers as necessary, to discourage root growth invasion on pavement.
- Understory trees and shrub masses planted in series of tiered layering (foreground, mid-ground, and background) to help define borders and plant groupings while combining interesting foliage textures and color.
- Background and screen trees strategically planted behind sidewalks to help create a green backdrop supporting the street tree canopy.



Urban gathering space example

C. Alley Conditions

Alleys should include landscaped areas on both sides of the lane adjacent to selected garages subject to the following options:

- Condition A: When a planter is less than 24 inches deep, provide a vertical vine, a vine support, and foundation planting.
- Condition B: When a planter is 24 inches deep or greater, provide a vertical shrub and foundation planting.
- Condition C: For long linear foundation planters, provide either a vertical vine with support or a vertical shrub at garages, depending on planter depth as described above. Additional plant material shall fill the remainder of the planter.



Private drive aisle with planting



D. Bus Shelters

The visual appearance and design of bus stops and the allocation of bus stop amenities that enhance pedestrian comfort and safety play a significant role in the decision to use mass transit. Amenities should be provided to improve the attractiveness of mass transit reducing parking needs. Bus stops shall be designed to provide an aesthetic accent in the community.

The design of bus stops shall be directed through coordination with Omnitrans, or their applicable design standards, if provided. Shelters shall be designed with the following factors taken into consideration:

- The durability and strength of materials.
- The resistance of chosen materials and paint treatments to weather conditions, graffiti, cutting, fire, and other forms of vandalism.
- Consideration of potential greenhouse effect during hot weather.
- The balance of external lighting within the commercial area with that within the bus shelter.
- Design which complements that of the urban character of the project.
- Wheelchair accessibility within the shelter.
- Inclusion of trash can and newspaper boxes.
- Use semi-transparent material(s) that allow bus operators to see inside the shelter.
- Wheelchair marking/placard that indicates dedicated wheelchair space within the shelter.



Inspirational decorative structures

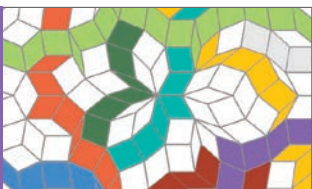

E. Neighborhood Landscape

To further the hierarchy of scale and variety, individual neighborhood character is allowed while maintaining connectivity within and between adjoining neighborhoods. Open space areas within a neighborhood should promote physical action and social interaction but at smaller, appropriately scaled spaces. The landscape at the neighborhood edges shall be designed with care.

- Landscaped areas along street frontages shall be appropriate to the scale, orientation, and purpose of the area. In addition, they should promote walkability, pedestrian comfort, and help strengthen the aesthetic character of the community.
- Perimeter landscape shall reflect the character of the community and at the same time, employ water conservation techniques to provide a sensible and complete landscape solution.
- Sufficient space must be provided between driveways and garden walls to allow for the growth of the tree trunks.
- Thorned trees must be avoided in areas where children play or ride bicycles.
- All landscape shall be maintained.

The following key design practices should be considered:

- Design planting to identify and support gathering spaces, walkway and pathway intersections.
- Frame desirable views and vistas.
- Screen and soften undesirable views.
- Size and place trees and plant material appropriate with neighborhood scale and the size of planters.
- Consider opportunities for summer shade and sunlight penetration.
- Encourage courtyard placement adjacent to sidewalk or pathways.
- Feature a cohesive and thematic mixture of trees, shrubbery, and ground covers with different shapes, textures, and colors.
- Use mass planting concepts for climate-appropriate plants, allowing growth to natural sizes and forms.
- Plant accent shrubs to highlight unit entries.



Varied examples of neighborhood landscape elements



Attached Homes

The landscape design for attached housing developments serves as a unifying element. The following concepts shall be included:

- Allow for a hierarchy of landscape open spaces from gathering areas and semi-private open spaces to smaller, more intimate spaces. The design of each of these types of spaces must be appropriate in scale and function, and reinforce the overall theme.
- The location, configuration, and quality of the private open spaces (where provided) for each unit are extremely important. It is encouraged to promote natural light penetration into these spaces to increase visibility and livability.
- Trees should be strategically located so as to help mitigate any second floor window to window incursion and screen private open space (where provided) at the ground level.
- Where applicable, tree/plant massing will be planted informally to break the monotonous pattern of equal spacing and create for a more vibrant rhythm.



Detached Homes

The landscape design for high-density detached housing creates a sense of place within each development. The following concepts shall be included:

- Front yard landscaping with a permanent automatic irrigation system shall be provided by the builder.
- Front yard landscape shall not exceed 50 percent turf and shall include appropriate size shrubs and trees.
- Feature a mixture of trees, shrubs, and ground covers with different shapes, textures, and colors.
- Size and place trees appropriate to the neighborhood scale.
- Opportunities for summer shade and sunlight penetration shall be considered.



Variety of home types

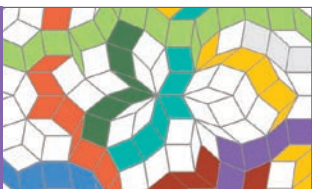

F. Tiered Landscape Program

Landscaping for PAI shall follow a tiered planting concept as outlined in Table 8.7: General Tiered Landscaping Requirements. By using different scales, forms, colors, and/or textures of plant materials, tiered (or layered) planting visually increases the depth of planters and promotes interest and diversity. The application of tiered planting is required to enhance the visual character of the project by softening the appearance of walls and fencing along major community roadways (the Vine and secondary entries). The tiered concept shall also be applied at the neighborhood level (along local streets) and in front of attached or detached high density housing. A selection of acceptable planting materials is found in the plant palette. Table 8.8A: Specific Tiered Landscaping Requirements for Yards and Table 8.8B: Specific Tiered Landscaping Requirements for Open Spaces provide details on how to approach multi-layered landscaping in yards and open spaces.

Table 8.7: General Tiered Landscaping Requirements

Layer	Description	Size
Layer A	Low spreading ground cover ⁽¹⁾ (including turf or turf substitute)	Under 12" height
Layer B	Low mounding shrub/ground cover ⁽¹⁾⁽²⁾ (informal mass planting)	12"- 30" height
Layer C	Low hedge (formal - linear)	12"- 30" height
Layer D	Medium shrub ⁽²⁾ (informal mass or hedge)	24-inch - 48" height
Layer E	Large shrub ⁽²⁾ (informal mass or hedge)	42"- 60" height
Layer F	Vertical (growth habit columns rather than horizontal)	42"- 72" height
Accent	Strategically located specimens	Varies

¹ Ground cover material shall be permeable and be able to retain moisture in the root zone, and reduce dust and weeds. Examples of appropriate ground plane materials include decomposed granite (3/8" minus with 11% fines), fractured gravel (3/4"-1"), fractured rock (2"- 6"), river rock (4"- 9"), shredded bark, and ornamental grass.

² Shrubs shall be a minimum of 5-gallons in size; in any "multi-layer" scheme. Shrubs serving as the first (shortest) layer, a 1-gallon shrub size or rooted cutting is acceptable.

Table 8.8A: Specific Tiered Landscaping Requirements for Yards

Planter Width	Number of Layers Required	
	Front Yards	Side Yards
18"- 30"	1	1
30"- 48"	2	2
48"- 60"	2 or 3	2
60" & up	3	3

Accent planting is encouraged depending on length of planter and could, depending on its use, count as a layer.

Table 8.8B: Specific Tiered Landscaping Requirements for Open Spaces

Planter Width	Number of Layers Required
	Large Open Spaces
18"- 30"	1
30"- 48"	1
48"- 60"	1
5-foot - 12-foot	2
12-foot & up	2 or 3

Accent planting is encouraged depending on length of planter and could, depending on its use, count as a layer.

8.5.3 Community Walls and Fencing

Walls and fences can be used as integral community features that enhance landscape design, privacy, and reinforce thematic design appropriate to maintain pedestrian connectivity.

Walls or fences that adjoin a PAI boundary or 4th or 6th Streets, identified in Figure 8.17: Setback Locations, shall be deemed “community walls.” Other walls and fencing are known as “product walls” and “view fences.”

- Community wall and fence designs, materials, colors, and finishes shall complement adjacent architecture while keeping the community design theme cohesive.
 - Incorporate the use of complementary pilasters or other design elements to help break up long stretches of walls and provide interest and rhythm.
- View fences or view walls along community open spaces are encouraged wherever privacy or screening is not necessary.
- Product walls and fences shall complement building design within commercial areas and be constructed of community-appropriate materials, colors, and textures.
- Openings or pedestrian connections will be provided at appropriate intervals.
- Vehicular gates and view fences should not be visible from the Vine unless allowed by the next bullet.
- Gates and view fences or walls shall be permitted where required by Building Code and/or to secure private spaces, parking, and amenities with due regard for resident safety. To facilitate and encourage walking and bicycle use through the community and adjoining properties, pathways will be established from pedestrian connections to adjacent property. Refer to Figure 8.52: Pedestrian Connection to Adjacent Property for an example of these connections.



Integrated use of architecture, decorative wall, and landscape



- Walls or fences may also be used to screen service areas, utilities, and trash areas.
- Precise locations of walls, fences, and gates will be determined on a case by case basis, at DRC, as project plans are submitted and reviewed.

A. Parcel and Retaining Walls

- Product walls include: side yard wall returns, side yard privacy walls along corner lots, and rear yard privacy walls along neighborhood streets.
- Where two product walls meet at adjoining parcels, walls shall match in color and finish, or have a unifying transitional element such as a pilaster at the connection point.
- Retaining walls may be combined with a product or community wall.
- All retaining walls must be damp-proofed. Walls must also be adequately drained, if required, on the surcharge side.

Graffiti-resistant aesthetic surface shall be applied consistent with Graffiti Resistance standard of the City's Development Code.



Inspirational lighting images

8.5.4 Urban Lighting Design

This section addresses urban area illumination for safety, security, and ambience, including lighting for parking areas, pedestrian walkways, architectural, and landscape features. Lighting on public and private streets shall meet City standards. Any deviations are subject to Engineering Services Department approval during the Site Development Review.

Lighting should provide a soft wash of light over illuminated objects, such as monumentation. Hierarchy shall be established by using a variety of lighting fixtures and illumination levels based on lighting design intent.

- Security lighting shall be sensitively designed to ensure that no off-site glare is directed to neighboring uses and that the overall intensity of the site lighting is not excessive.
- Use LED and other current lighting technology to promote sustainability.

A comprehensive lighting plan shall be prepared and approved in conjunction with the site plans submitted for approval to the City of Rancho Cucamonga.

- Exterior lighting within a parking lot, service area, or other intentionally lit area should be located and designed to minimize direct glare outside of the specific area.
- Lighting sources shall be shielded, diffused, or indirect in order to avoid glare to pedestrians and motorists.
- Lighting fixtures should be selected and located to confine the area of illumination to the boundaries of the non-residential area.
- Pedestrian paths should be lighted by pole, string lights, directed uplighting, urban art, or bollard-type fixtures; these elements should be pedestrian-scaled, typically limited to a maximum height of 15 feet for pole lights (including the base), or six feet for bollards.
- All lighting fixtures shall be designed to resist vandalism.

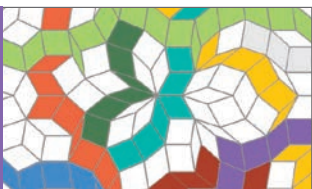

8.5.5 Signs

Signs and graphics play a large role in creating and reinforcing the desired feel of a vibrant community. Controlled wayfinding and identity signs are also a major factor in creating and preserving the design character of the overall community. Sign design should be respectful of the surrounding area, yet have a distinctive character that reflects the mixed use environment.

A Uniform Sign Program (USP) will be prepared for the entire community to allow individuality of signs while maintaining a unified and cohesive overall appearance. All signs shall be consistent with private property sign regulation standards of the City's Development Code. The USP will be processed as consistent with sign requirement review procedure standards of the City's Development Code.



Building Sign Example



Awning/Canopy Example



Monument Sign Examples

A. Community Directional Signs and Wayfinding

Community directional signs facilitate the flow of traffic and are typically horizontal signs with individual tenant or residential community names and directional arrows. Guidelines for community directional signs include:

- A detailed wayfinding program with the placement and location of directional signs shall be developed as part of the USP program.
- To avoid confusion, directional signs will typically have no more than 10 listings with arrows.
- The project name or logo map be located on the sign.
- Vehicular directional signs should be located at strategic locations to act as wayfinding and identity markers for pedestrians once they have parked their car.
- The placement of directional signs shall maintain sight lines.



Directional Sign Examples

B. Community Pageantry

Community pageantry includes flags, banners, canopies, directories, ground-mounted graphics, flower pots or other similar, temporary or permanent (but changeable) elements. The intent is to allow regular changes to the pageantry elements in terms of color, design, and other visual content so the pageantry can always look current. Pageantry may be located within the right-of-way, within the setback, or on private property.

Guidelines for pageantry include:

- Paper, cardboard, styrofoam, stickers, and decals are not acceptable forms of pageantry (directories or kiosks excepted).
- Pageantry shall not include flashing, flickering, rotating, or moving lights.

Temporary Decorations Temporary graphics and decorations for a holiday season which do not advertise merchandise or services are permitted, provided that such graphics and decorations are installed not more than 30 days before the holiday or holiday season and removed not later than 15 days after the holiday or a holiday season.

- Temporary decorations placed within the public right-of-way to be approved by the City and RCFPD.



Pageantry Flag Example

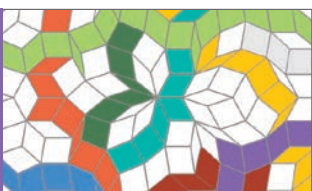

8.6 Public Safety

8.6.1 Fire Protection

Fire protection and emergency medical services are provided by the Rancho Cucamonga Fire Protection District (RCFPD) for PAI from seven fire stations. The closest fire station is Station 174, located at Milliken Avenue and Jersey Boulevard less than a third of a mile away.

RCFPD has developed policies and standards that provide interpretation and explanations of the California Fire Code. All development within the Specific Plan area will be reviewed by RCFPD for compliance with policies and regulations as applicable. Policies and regulations include but are not limited to, the provision of adequate fire access (roadway widths, turning radii, distance of hose pull to farthest portion of structure, residential gates, address signage, and knock boxes), adequate water sources (number and location of fire hydrants), and temporary access roads and fire hydrants.

As part of the site development review process, a way of addressing the buildings, open spaces (3rd Places spaces and paseos) and parking areas will be developed to the satisfaction of RCFPD to ensure that persons calling for emergency services from mobile phones can provide emergency responders with an accurate location identification.

Required Fire Apparatus Access Roads, including private drives designated as Fire Apparatus Access Roads, shall maintain the required horizontal or vertical clear space to the satisfaction of RCFPD. Mature tree canopies or shrub landscape shall not encroach into these required fire access roads. All access control gates shall be equipped with a RCFPD approved means of allowing emergency responder access.

Required building separations shall maintain the required horizontal or vertical clear space to the satisfaction of RCFPD. Where parapets or other similar architectural elements are used to screen roof-mounted equipment, or if roof deck walls are provided, RCFPD required parapet ladders may be required to the satisfaction of RCFPD. All rooftop photovoltaic (PV) systems, gardens or decks shall be reviewed for proper access for emergency responders.

Minor changes to the Specific Plan that are regulated by RCFPD adopted Fire Code can be processed similar to Minor Exceptions as defined by the City's Development Code. Responsibility for reviewing and approving minor changes, as well as interpreting the Specific Plan with regard to fire and life safety provisions is assigned to the Fire Marshal of RCFPD.

8.6.2 Law Enforcement and Crime Prevention

Law enforcement and crime prevention services are provided by the San Bernardino County Sheriff's Department (SBCSD) under contract with the City of Rancho Cucamonga. Police impact fees are imposed on new residential and commercial development.

All development within PAI will be reviewed by the Police Department for compliance with their policies and regulations as applicable. Rancho Cucamonga values effective crime prevention and strives to find creative ways to make residents and businesses safe. Crime Prevention Through Environmental Design (CPTED) is a planning tool that focuses on the property design and use of the built environment to deter and prevent crime. The intent of the PAI design is provide natural surveillance and access control, territorial reinforcement and management and maintenance. In addition, infrastructure to support the Police Department's electronic systems shall be provided. All site plans will be reviewed by the City to ensure they meet these considerations.

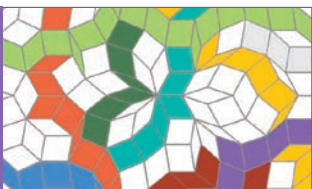

8.7 Implementation

This Section contains the regulatory procedures and development regulations to implement PAI only. The regulatory procedures contain a mix of reliance upon existing processes described in the Rancho Cucamonga Development Code with additional procedures that are unique to PAI of the IASP:

1. The land use and development procedures shall be in accordance with Article 2 of the City's Development Code.
2. Proposed subdivisions of land shall be processed, reviewed, and approved in accordance with Title 16 - Subdivisions of the Rancho Cucamonga Municipal Code.
3. No master plan(s) shall be required; however if available, site plans shall show adjacencies on the surrounding parcels.
4. The following minor, technical, and/or informational revisions to the Specific Plan shall be processed administratively as described in Sections 17.16.020 Official Code Interpretations and 17.16.030 Plan Check/Zoning:
 - The addition of new information to the Specific Plan, in the form of maps and/or text, for the purpose of clarification that does not change the effect or intent of any regulation;
 - Changes in Placetype boundaries (shown on Figure 8.6: Conceptual Development Plan by Placetype) resulting from final road alignments and/or geotechnical or engineering refinements to the tentative and/or final tract map provided that the number of dwelling units and/or dwelling units per acre within the affected Placetypes is consistent with the minimum/maximum number and/or density range that applies to the subject Placetypes;
 - Clarification, including determination of meaning and intent, of any unclear or vague section, portion of a section, phrase, or word contained within this document;
 - Typographical and grammatical errors;
 - Revisions to tree species, size, and location, and to other landscape material in the public right-of-way are subject to the review and approval of the Engineering Services Department;

- Revisions to the location of the infrastructure and/or service providers (such as drainage systems, roads, water and sewer systems, etc.) provided that the agency or jurisdiction that regulates such infrastructure and/or service has reviewed and approved the revisions;
- Revisions to the determination of public and private facilities provided that the agency or jurisdiction that regulates such facility has reviewed and approved the revisions; and
- Variations in the gross density within any parcel or Placetype shown on Figure 8.6: Conceptual Development Plan by Placetype and Table 8.1: PAIA Development Program, may occur at the time of final design of the parcel depending upon the residential product identified for development through the Intensity Monitoring Program and provided the maximum number of residential dwelling units permitted for the PAI area is not exceeded.

8.7.1 Intensity Monitoring Program

Table 8.1: PAIA Development Program provides the design intent and range of development for PAI within the Specific Plan; however it is recognized there is a need for flexibility in planning to accommodate future development constraints and market demands while maintaining a minimum intensity. Intensity may be transferred between parcels consistent with the intensity assigned to the Placetype the parcel is located in provided the minimum required units are achieved. If any transfer results in an intensity that is inconsistent with the land use Permitted Density range for any Placetype, the transfer shall require a Specific Plan amendment.

An Intensity Monitoring Program is established to ensure that both the minimum intensity is developed as well as a maximum intensity is not exceeded. Table 8.9: Intensity Monitoring Program shall be maintained and updated by the Planning Department at the time of each Site Development Review. Unless a proposed project is exactly consistent with the target intensity shown on Table 8.9: Intensity Monitoring Program, an intensity transfer is required. If the said transfer is within the intensity ranges for the land use assigned to the Placetype, then it is assumed to be consistent with this Specific Plan. Intensity transfers shall be subject to the following documentation:

- The resulting intensity of both the granting and receiving parcels shall be consistent with the density ranges specified for each parcel.
- The overall maximum Specific Plan intensities identified in Table 8.1: PAIA Development Program shall not be exceeded.
- Written agreement from each property owner has been received by the City.
- If necessary, supporting technical studies shall be provided that substantiate adequate infrastructure exists to support the intensity transfer.

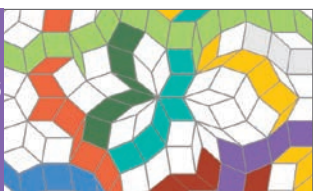

Table 8.9: Intensity Monitoring Program

Parcel	Placetypes	Acres	Permitted Density Range		Minimum Permitted Units		Maximum Permitted Units		Transferred Units			Project Name	
			Min	Max	Units	Units	Unit Target	Approved Residential Units	In	Out	Application Number		Date Approved
S-14	Core Living	9.55	18.0	35.0	172	334	172	334	172	0	0		
S-15	Village Neighborhood	6.71	16.0	28.0	107	188	107	188	114	0	0		
S-16	Village Neighborhood	6.67	16.0	28.0	107	187	107	187	113	0	0		
S-17	Village Neighborhood	10.58	16.0	28.0	169	296	169	296	180	0	0		
S-18	Village Neighborhood	3.99	16.0	28.0	64	112	64	112	68	0	0		
S-19	Mixed Use	2.87	14.0	40.0	0	115	0	115	0	0	0		
S-20	Village Neighborhood	9.85	16.0	28.0	158	276	158	276	166	0	0		
S-21	Village Neighborhood	12.19	16.0	28.0	195	341	195	341	207	0	0		
S-22	Core Living	4.54	18.0	35.0	82	159	82	159	82	0	0		
Potential Subtotal		66.95	15.7	30.0	1,053	2,008	1,053	2,008	-	-	0		
Net Developable Minimum Required/Maximum Allowed		66.95	15.7	21.7	1,053	1,450	1,053	1,450	1,102				

8.7.2 Definition of Terms

The meaning and construction of words, phrases, titles, and terms shall be the same as provided under Universal Definitions of the City's Development Code unless otherwise specifically provided herein. Where terms in this document differ from the City's definition, those terms are defined in the Glossary.

8.7.3 Financing and Maintenance of Improvements

The financing of construction, operation, and maintenance of public improvements and facilities (the "facilities"), and public services for PAI may include funding through a combination of financing mechanisms. Final determination as to the facilities to be financed and as to maintenance responsibilities, whether publicly or privately maintained, will be made prior to approval of tentative maps. The following financing options can be considered for implementation:

A. Facilities Construction Funding

- Private capital investment for the construction of facilities.
- Community Facilities District (CFD) established pursuant to the Mello-Roos Community Facilities District Act of 1982, or other special district, to provide funding for the construction of a variety of public facilities and the provision of public services.

B. Operation and Maintenance of Private Facilities

- By individual private property owner.
- By home owners' or property owners' association.

City approval is a prerequisite for the implementation of any and all establishment of financing mechanisms.

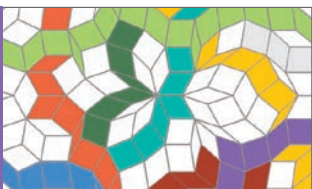

C. Operation and Maintenance of Public Facilities:

Public facilities are planned for public maintenance by either the City, CFD, or by the appropriate utility service provider. These public facilities include but are not limited to the following:

- Public streets (including the pedestrian realm walkway with tree wells).
- Public traffic signals and traffic control signs.
- Public on-site water facilities, sewer facilities, and drainage facilities within public streets.
- Street lighting within public rights-of-way.
- Water quality facilities for treatment of flows in public streets.

D. Home Owners' or Property Owners' Association / Private Property Owner Maintenance:

One or more associations may be established for the maintenance of private common area improvements. Private improvements to be maintained by the association(s) may include but are not limited to the following private facilities:

- Private streets, and drive aisles.
- Traffic control signs.
- Open space areas, the lon, and multiuse trails.
- Detention and water quality treatment facilities not located in public streets.
- Private sewer, storm drains and water systems.
- Parks and recreational facilities.
- Walkways, entries and signage, and paseos.
- Community theme walls and fencing.
- Courts, parkways, and landscaping within the residential areas.
- Common area facing wall surfaces, and internal slopes fronting streets.
- Common area landscaping and lighting.

E. Joint Use Public Facility

A “Joint Use Public Facility” (alternately referred to as a “Municipal Joint Use Facility”) of up to 25,000 square feet in floor area is required as a mitigation of impacts to public facilities. In furtherance of this mitigation, the applicant shall:

- Dedicate 1.75 acres (net) of land for the location of the “Joint Use Public Facility” to address the increase in demand for public facilities to support police, library, and community services. This land shall be generally located at the intersection of The Vine and 7th Street. The dedication shall occur after the completion by the applicant of full public improvements and include all utilities stubbed to the property line.
- Pay an initial deposit amount equal to the greater of \$11,000,000 or the alternate specific Development Impact Fees (DIF) impact fees, to the City (or fund through a similar financial mechanism acceptable to the City) upon issuance of the first building permit for the construction of this facility. Development Impact Fees (DIF) collected for police, library, and community and recreation center impact fees shall be credited to the applicant as an offset to the \$11,000,000 deposit. The final contribution shall include an annual, compounded, 3 percent cost inflation escalator up to the start of construction of the facility. Alternatively the applicant may choose, up until the time the first building permit is issued, to seek reimbursement from DIF fee’s collected for police, library, and community and recreation center impact fees collected for all construction within one (1) mile radius of the boundary of Planning Area I (PA I), for a period not to exceed 10 years from the issuance of the first building permit. Once a decision is made, it is irrevocable.

Construction of this facility shall be required to commence by the time of the issuance of the building permit for the 2,000th residential dwelling unit. The final size, site layout, operational requirements, and design features of the facility will be subject to the City’s review and approval.

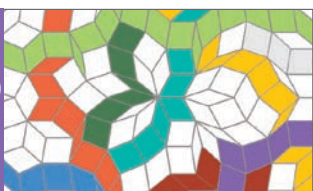

8.7.4 Phasing

PAI development is dependent upon the market and the ability to attract future end-users. Where possible, infrastructure within the project boundary may be installed in two or more overlapping or consecutive phases with Phase 1 starting south of 6th Street. These improvements include rough grading, storm drain, water, sewer, dry utilities, and street improvements.

Home construction will include many phases. Starts will be based on sales of homes in the previous phase. It is unclear at this time the final number of phases. The number of phases and number of units in phases may be altered from time to time.

8.7.5 ALUCP Compliance

PAI is within the Airport Influence Area (AIA) established by the LA/Ontario International Airport Land Use Compatibility Plan (ONT ALUCP). Construction activities and future development in PAI shall be implemented in compliance with the applicable policies and requirements as identified in the ONT ALUCP. These include, but are not limited to:

A. Compliance with Federal Aviation Regulations (FAR) Part 77, Objects Affecting Navigable Airspace, Subpart C, Obstruction Standards (Airspace Protection Policy A1)

Building height limits in Sub-Area 18 shall not exceed the height limits prescribed in the ONT ALUCP which is 60 feet south of 6th Street and 70 feet north of 6th Street. Proposed structures shall comply with Federal Aviation Administration (FAA) height restrictions. Prior to approval of each tract map and/or parcel map, whichever comes first, the Property Owner/Developer shall submit an FAA Determination of No Hazard to Air Navigation to the City of Rancho Cucamonga. The Property Owner/Developer shall notify the FAA via filing FAA Form 7460-1 to initiate the FAA review and determination process. The Property Owner/Developer shall comply with the requirements of the FAA determination, including but not limited to further aeronautical study; installation of roof-top obstruction lighting; and/or marking requirements, if necessary.

B. Avigation Easement

In compliance with ONT ALUCP Airspace Protection Policy A2b and Special Compatibility Policy SP1a, an avigation easement shall be dedicated to the owner/operator of the Ontario International Airport for any portion of PAI that is within the High Terrain Zone, which includes the areas between 4th Street and 6th Street.

C. Real Estate Transaction Disclosure

In compliance with Airport Land Use Compatibility Plan for LA/Ontario Airport's (ONT ALUCP's) Overflight Policy O2, a Real Estate Transaction Disclosure is required for all development in PAI. State Law (Business and Professions Code Section 11010) provides the following disclosure language:

NOTICE OF AIRPORT IN VICINITY: This property is presently located in the vicinity of an airport, within what is known as an airport influence area. For that reason, the property may be subject to some of the annoyances or inconveniences associated with proximity to airport operations (for example, noise, vibration, or odors). Individual sensitivities to those annoyances can vary from person to person. You may wish to consider what airport annoyances, if any, are associated with the property before you complete your purchase and determine whether they are acceptable to you.

8.7.6 Severability

If any section, subsection, sentence, clause, phrase or portion of this Specific Plan, or any future amendments or additions hereto, is for any reason found to be invalid or unconstitutional by the decision of any court of competent jurisdiction, such decision shall not affect the validity of the remainder of this Specific Plan document or any future amendments or additions hereto. The City hereby declares that it would have adopted these requirements and each sentence, subsection, clause, phrase or portion or any future amendments or additions thereto, irrespective of the fact that any one or more section, subsections, clauses, phrases, portions or any future amendments or additions thereto may be declared invalid or unconstitutional.

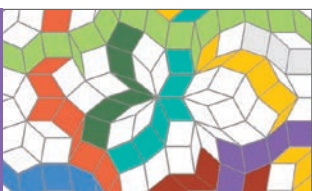

8.7.7 Interpretation

Every effort has been made to provide policies and regulations that are clear; however, interpretations will be necessary when unanticipated issues arise. If any situation arises in the implementation of this Specific Plan that is not addressed by specific development regulations, or if an issue, condition, or situation arises that is not clearly addressed, the Planning Director shall provide an interpretation based on such City codes, goals, policies, plans, and requirements as are most closely related to the subject matter of the issue or situation to be interpreted.

In all matters, if there is a conflict between the provisions of this Specific Plan and the provision of the Rancho Cucamonga Development Code (RCDC) this Specific Plan shall prevail. As to matters not categorically superseded and not otherwise specifically addressed by this Specific Plan, the RCDC shall apply and shall be interpreted in a manner that is consistent with the goals and objectives of this Specific Plan. In no case shall any requirement of the California Building Codes be superceded by this Specific Plan.

Administrative interpretations of the Planning Director may be appealed pursuant to the appeal procedures and timelines set forth in the RCDC regarding appeals of administrative interpretation.

8.8 Glossary

3rd Place Spaces

3rd Place spaces are transitional social spaces that link people, neighborhoods, and lifestyles. A 3rd Place isn't a singular place or large venue, but rather a collection of smaller more intimate spaces designed to be unique and quirky and encourage people-gathering. Beyond work, school, and home, these 3rd Place spaces are memorable and unique spaces that people adopt and craft into something remarkable and define the character of the surrounding neighborhood. As part of the healthy, active community goals, a network of 3rd Place spaces will be integrated within and between neighborhoods to foster a dynamic setting for active and social living.

Active Architecture

The variation of building form, wall movement, detailing, entry location, or window placement provide human scale and interest along an elevation.

Color Blocking

Utilization of color on elevations to visually enhance specific areas of a building mass.

Common Open Space

May include but is not limited to: verandas, plazas, courtyards, roof top decks, programmed or natural outdoor space, tot lots, dog parks, paseos and pathways, sitting areas, 3rd Place spaces, and similar spaces open for use by a group of homes, all homes, or the public.

Pedestrian Crossings

Pedestrian crossings include crosswalks at intersections, crosswalks with center islands, and Table Top crossings.

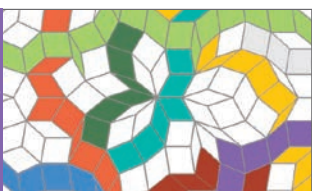

Pedestrian Realm

The pedestrian realm extends from the curb edge to the building frontage. This pedestrian-dominated space is an integral part of the streetscape, necessary to balance the use of the streets for vehicle movement and pedestrian access. Amenities that contribute to a comfortable and inviting pedestrian realm may include hardscape, planting, seating, dining or patio areas, and bicycle parking. A quality pedestrian realm will connect the different functions and public spaces of the community and invite people to walk, cycle, and use public transit.

Placetypes

Placetypes are a progressive means of regulating the built environment. Placetypes integrate development principles, built form guidelines, and design criteria to create holistic people-centric places instead of using traditional land use-centric regulations.

The development plan for PAI uses a Placetype-based regulating plan to establish the minimum design parameters and land use options.

Primary Elevations

Primary Elevations are all elevations directly facing the Vine, 4th, 6th Streets and 7th Streets, and the street connecting the Vine to the Metrolink property. These elevations have the greatest impact on the quality and character of the community. The Primary Elevation may be a front or side facade. Garage doors should not face the Primary Elevation.

Private Open Space

May include but is not limited to: covered porches, patios, stoops, courtyards, balconies, yards, roof top decks, and similar spaces reserved for private use by a single unit.

Progressive Parking Management Strategy

A progressive parking management strategy to reduce minimum parking requirements may include traditional, proven, or progressive strategies that reduce the amount of land devoted to parking. Strategies that could be considered include, but are not limited to, valet parking solutions, bicycle share program, or an active car-share program.

Secondary Elevations

Secondary Elevations include all non-Primary Elevations where front entries are located, or the elevations that face a Grand Paseo, 3rd Place space, private ROW, shared amenity, or other key neighborhood feature. The Secondary Elevation may be a front, side, or rear facade; garage doors are permitted along the Secondary Elevation.

Table Top Crossings

A Table Top Pedestrian Crossing is a traffic calming device that raises the entire wheelbase of a vehicle to reduce its traffic speed and increase the aesthetic and safety of the pedestrian crossing. It includes a flat section in the middle with ramps leading up-to and down-from the pedestrian crossing; sometimes it is constructed with textured materials or color designs on the flat section. Vehicle operating speeds for streets with Table Top crossings are higher than standard speed humps and range from 25–45 mph, depending on the spacing. See Section 8.3.6.D. Pedestrian Circulation for more details.

Wrap/Podium Housing

Wrap/Podium housing are attached, multiple-dwelling building(s) where the required resident parking spaces are typically provided within a parking structure (subterranean or above-ground) or on a surface parking lot.

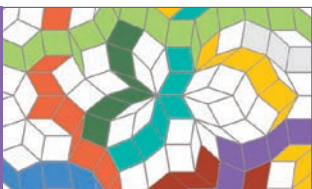

Appendix A Engineering

Prepared by:



Engineering Communities for Life

9302 Pittsburgh Avenue Suite 230
Rancho Cucamonga, CA 91730
909-481-6322
Mark Bertone, President



Encompass Associates, Inc.

5699 Cousins Place
Rancho Cucamonga, CA 91737
909-684-0093
Aaron Skeers, P.E.

1.0 Grading

Development of PAI will require mass grading of approximately 160 acres. A grading concept plan has been designed for both the north and south portion of the site. Refer to "Figure A-1: Conceptual Phase 1 Grading Plan", "Figure A-3: Conceptual Phase 2 Grading Plan" and "Figure A-5: Conceptual Phase 3 Grading Plan". The grading concept will minimize the visual impact of grading by designing the site in a manner that limits the amount of cut and fill slopes or large retaining walls between the parcels. Based on our preliminary calculations we anticipate balancing the site.

The north portion of the site currently slopes southerly from 8th Street to 6th Street at an average slope of approximately 2 percent from north to south. The east and west sides of the site are almost the same elevation. Based on preliminary earthwork calculations the north portion of the site will require approximately 506,000 cubic yards of raw excavation and 356,000 cubic yards of raw fill. Taking into consideration subsidence and shrinkage losses the required fill volume has been calculated to be 482,000 cubic yards. Therefore the approximate export from the north portion of the site is 24,000 cubic yards. We anticipate that this export can be utilized on the south portion of the site.

The south portion of the site currently slopes southerly from 6th Street to 4th Street at an average slope of approximately 1.5 percent from north to south. The east and west sides of the site are almost the same elevation. Based on preliminary earthwork calculations the south portion of the site will require approximately 405,000 cubic yards of raw excavation and 303,000 cubic yards of raw fill. Taking into consideration subsidence and shrinkage losses the required fill volume has been calculated to be 418,000 cubic yards. Therefore the approximate import required for the south portion of the site is 13,000 cubic yards. We anticipate that this import can be utilized from the export from the north portion of the site. This leaves a net export of only

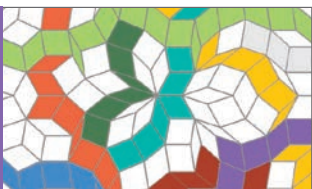

11,000 cubic yards. 11,000 cubic yards is approximately one percent of the entire volume of excavation. Since shrinkage factors can vary greatly we anticipate balancing the site and having little or no export from the project. Refer to “Figure A-2: Conceptual Phase 1 Cut/Fill Plan”, “Figure A-4: Conceptual Phase 2 Cut/Fill Plan” and “Figure A-6: Conceptual Phase 3 Cut/Fill Plan”.

Grading is expected to occur in three (3) phases, sequentially, however market conditions may require overlapping of grading over two or more areas concurrently. Phase one will consist of the entire area between 4th Street and 6th Street, including grading of the depressed northeast Urban Plaza. With Phase one, a temporary interceptor channel will be graded around the depressed northeast Urban Plaza to redirect existing flows away from the Ion Tunnel. Phase two grading will occur over Planning Areas N-6, N-7, N-8, N-9 and N-13. Phase three grading will occur over Planning Areas N-1 through N-5, N-10 through N-12.

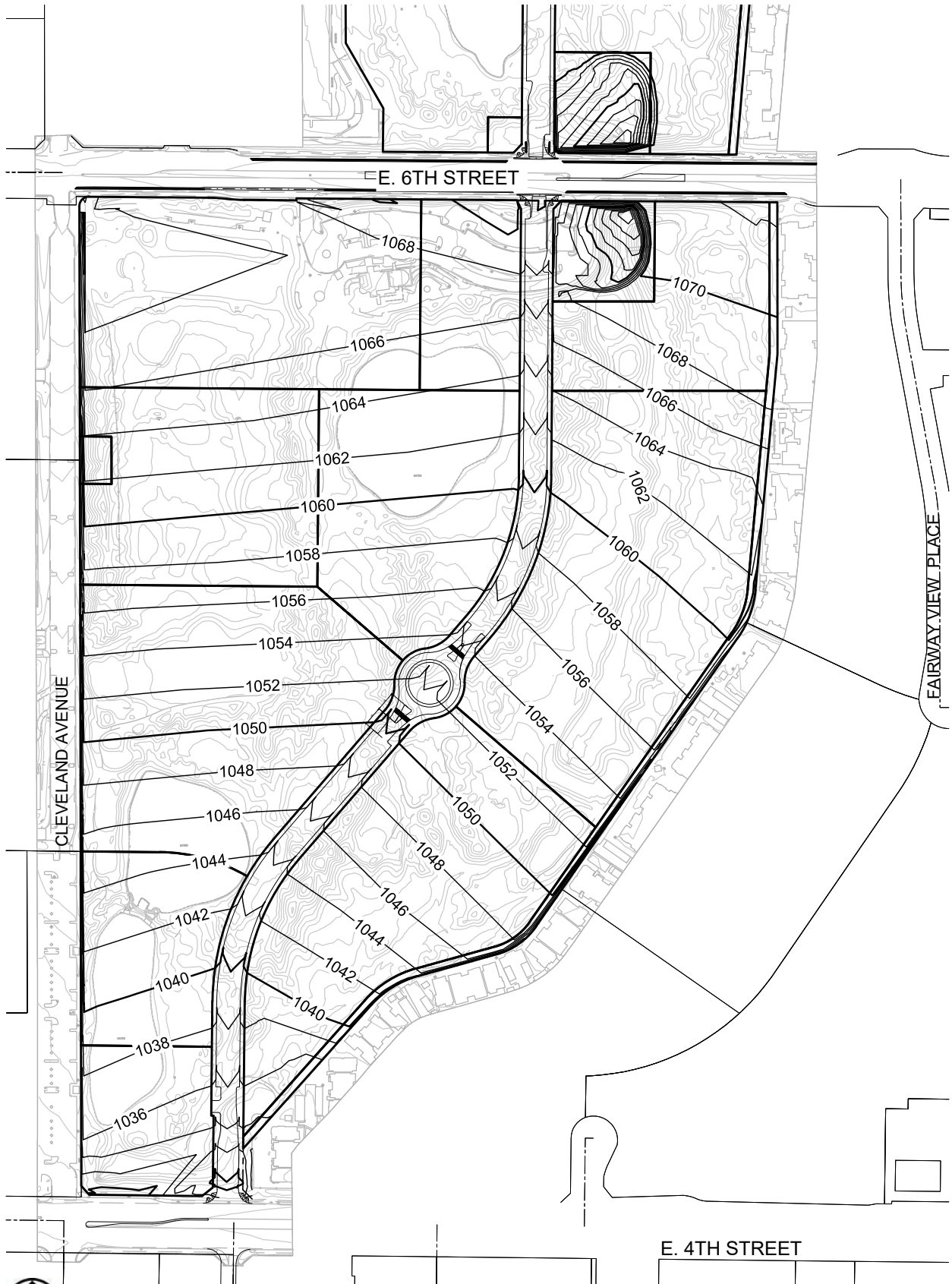
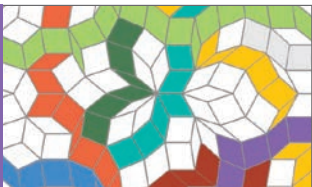

Figure A-1: Conceptual Phase 1 Grading Plan

Note: Figure not to scale.

LEGEND:

—1100— PROPOSED CONTOUR



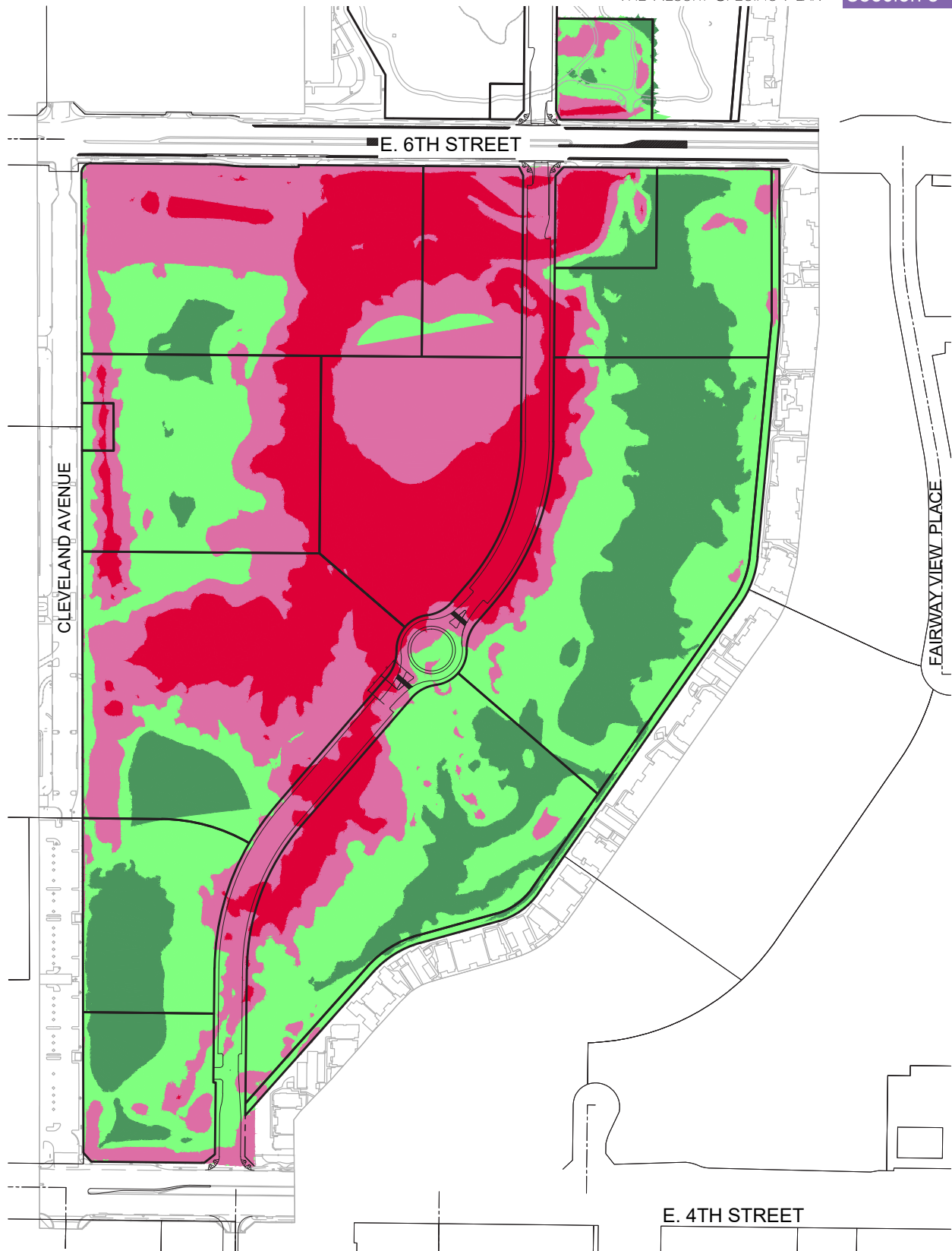

LEGEND:
 EARTHWORK

	-24' TO -6'
	-6' TO 0'
	0' TO 6'
	6' TO 20'

Figure A-2: Conceptual Phase 1 Cut/Fill Plan

Note: Figure not to scale.



PAGE INTENTIONALLY LEFT BLANK

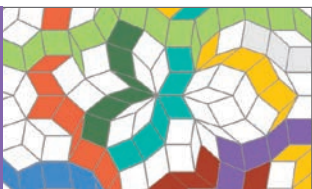



PAGE INTENTIONALLY LEFT BLANK

PAGE INTENTIONALLY LEFT BLANK

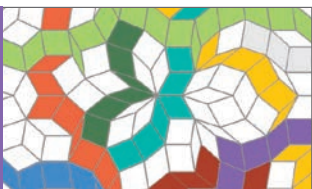



PAGE INTENTIONALLY LEFT BLANK

2.0 Storm Drainage

The site is currently developed as the Empire Lakes Golf Course with various surface and subsurface drainage conveyances on the property, and two detention basins installed to limit discharge to the pre-development condition. The detention basins were required at the time of the initial golf course development due to the fact that the 4th Street Storm Drain had not been constructed. Upon completion of the 4th Street Storm Drain, and the extension northerly in Cleveland Avenue, a pipe connection was made for the discharge of the detention basin.

Site drainage will be a combination of surface sheet flow and pipe flow with area and roof drains around buildings, and catch basins in streets and drives which intercept runoff. The mainline storm drain will flow southerly and will connect to the existing 4th Street Storm Drain located near the intersection with Cleveland Avenue.

The storm drain system will be constructed in three (3) phases. Phase 1 will include construction of a storm drain within 4th Street and the Vine between 4th Street and 6th Street. Additionally, a storm drain will be extended northerly in the Vine north of 6th Sixth Street to intercept captured existing runoff from the golf course that will be channeled away from the northeast Urban Plaza depressed graded area. A local storm drain will be placed within the Ion Tunnel to drain the depressed northeast Urban Plaza to PA S-23. Runoff within the depressed northeast Urban Plaza and the depressed PA S-23 will be handled in one of two ways: by pumping the collected runoff to the storm drain system in the Vine or by collecting the runoff and routing to a below ground injection well system that will recharge the groundwater basin. Refer to "Figure A-7: Conceptual Phase 1 Storm Drain Facilities Plan" and "Figure A-8: Conceptual Phase 1 Interim Grading Storm Drain Facilities Plan". Phase 2 will extend storm drain in the Vine to the intersection of 7th Street and Anaheim Place. Refer to "Figure A-9: Conceptual Phase 2 Storm Drain Facilities Plan". Phase 3 will extend storm drain in the Vine northerly towards Planning Area N-3. Refer to "Figure A-10: Conceptual Phase 3 Storm Drain Facilities Plan".

The PAI 4th Street Storm Drain Hydraulic Analysis assessed the capacity of the existing off-site storm drain in the cities of Rancho Cucamonga and Ontario and determined that the existing system can handle runoff from proposed PAI development.

The City of Ontario has reviewed the 4th Street Storm Drain Analysis and has concluded that the additional runoff resulting from the development of Empire Lakes will not affect the City's downstream storm drain system. Additionally, the County of San Bernardino has indicated that they will not require any permitting or approval triggered by the increase flows discharging into the Turner Basins north and east of Guasti Regional Park. Final drainage studies will be reviewed by both cities at the time of development.

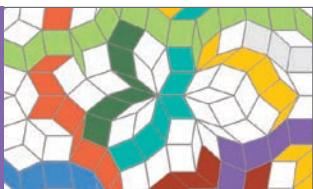

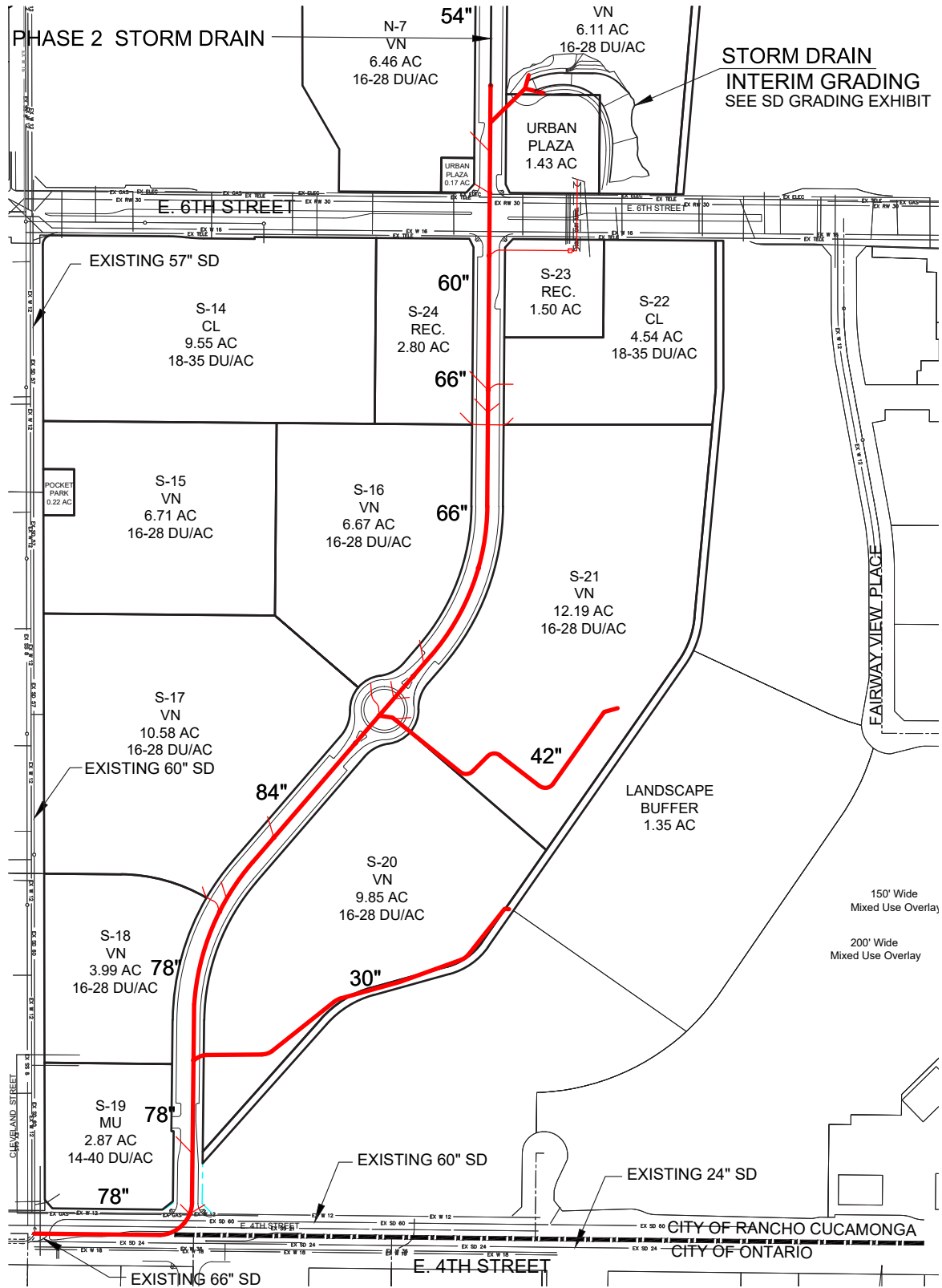

Figure A-7: Conceptual Phase 1 Storm Drain Facilities Plan

LEGEND:
 PROPOSED SD LAT.
 PROPOSED STORM DRAIN - DIA.
 EX. 66" SD EXISTING STORM DRAIN - DIA.

Note: Figure not to scale.



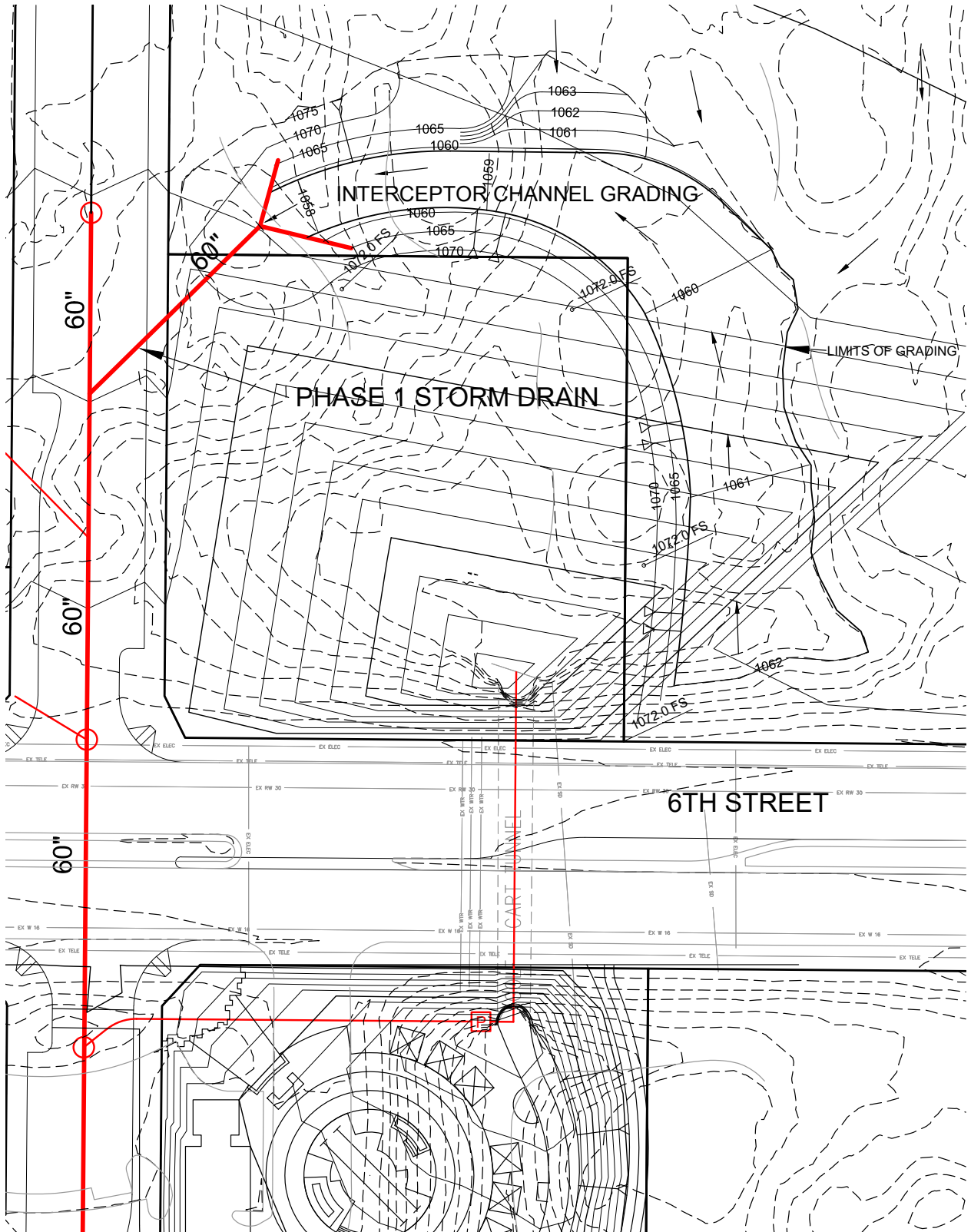
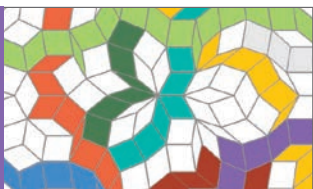

Figure A-8: Conceptual Phase 1 Interim Grading Storm Drain Facilities Plan

Note: Figure not to scale.

LEGEND:

- PROPOSED SD LAT.
- PROPOSED STORM DRAIN - DIA. 36"
- EX. 66" SD
- EXISTING STORM DRAIN - DIA.
- DIRECTION OF INTERIM FLOWS
- PROPOSED PUMP





PAGE INTENTIONALLY LEFT BLANK

PAGE INTENTIONALLY LEFT BLANK

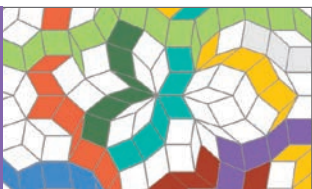

3.0 Storm Water Quality

The targeted high frequency, low flow storms will drain from the proposed streets onto the adjacent parkways, paseos, and parks to allow for enhanced filtration, infiltration, and peak reduction. Additional provisions will include pervious pavement for parking areas, infiltration trenches, pervious storm drain pipes and bioretention landscaping systems.

As previously mentioned, storm runoff from PAI will drain to storm drains in Cleveland Avenue and 4th Street. All flows will eventually enter the 4th Street system, which drains to an unimproved area of Cucamonga-Guasti Regional Park, part of the San Bernardino County Regional Park system west of Turner Avenue and south of 4th Street. Flows from this area then enter the Cucamonga Creek Channel, down to Prado Dam, into the Santa Ana River, and ultimately out to the Pacific Ocean. The existing storm drain facilities are adequate to handle the 100-year storm. Until such time that there are downstream regional storm water quality facilities specifically designed to mitigate pollutants in the runoff from the proposed PAI development, storm water quality mitigation will need to be satisfied on-site.

A number of BMP concepts will be utilized to address storm water quality mitigation requirements. These concepts include:

Hydrologic Source Control LID BMP - The primary BMP will be a hydrologic source control LID, where runoff is directed to landscaped areas and retained. In some cases, this retention will be in the form of a depressed area such as a basin, but more commonly it will just be an area that is held a few inches below the surrounding street, parking area, or storm drain inlet.

Infiltration LID BMP - Where retention of runoff is not feasible, or cannot mitigate the full design capture volume (DCV), the next priority BMP will be injection drywells and infiltration trenches. These drywells and trenches can be installed almost anywhere including in landscaped areas and under pavement, but should be avoided within 5 feet of buildings and walls. The injection drywell infiltration BMPs typically consist of two manholes, the first design to capture solids and sediment, with overflow conveyed to the second manhole, which has an open base and an 8-inch perforated pipe placed in a hole drilled 30 feet or more below the base of the manhole to maximize infiltration performance. The infiltration trench concept is simply a gravel trench,

typically 2 to 8 feet deep, from 2 to 5 feet wide, and is as long as needed or as space allows. The bottom of the trench reaches to a depth at or below native, undisturbed soil, or where compaction has achieved a relative density less than 90%. Good design practice includes an upstream inlet or system capable of filtering out trash and sediment. Further, the inclusion of a 12-inch or larger perforated pipe within the gravel bed helps to facilitate inspection and maintenance, and also serves to increase storage capacity. Proprietary below ground HDPE domed structures or CMP pipe can also be included to increase functionality.

Bioretention Systems - In locations where the other LID BMPs are not feasible or unable to mitigate the full DCV, volume-based filtration systems will be installed. These systems include bioretention systems, such as manufactured parkway planter or street tree well systems, rated to be effective at filtering runoff.

Bioretention Systems - In order to properly size and site the infiltration-type BMPs listed above, on site geotechnical investigations will be required. The double-ring infiltrometer test or standard (septic) percolation test are commonly completed to achieve an infiltration rate, ultimately in inches per hour, with the former test preferred. Because soil conditions can vary widely across a project, especially a large project such as Empire Lakes, these soil tests should be performed when final construction documents are being prepared, so that the tests are conducted at the proper location and depth for which the particular LID BMP will be constructed. However, infiltration rates are expected to be sufficient to support the proposed BMPs because this area is comprised of Hydrologic Soil Types A and B, defined by the USGS as being well-draining.

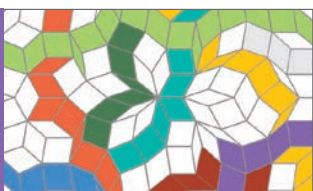

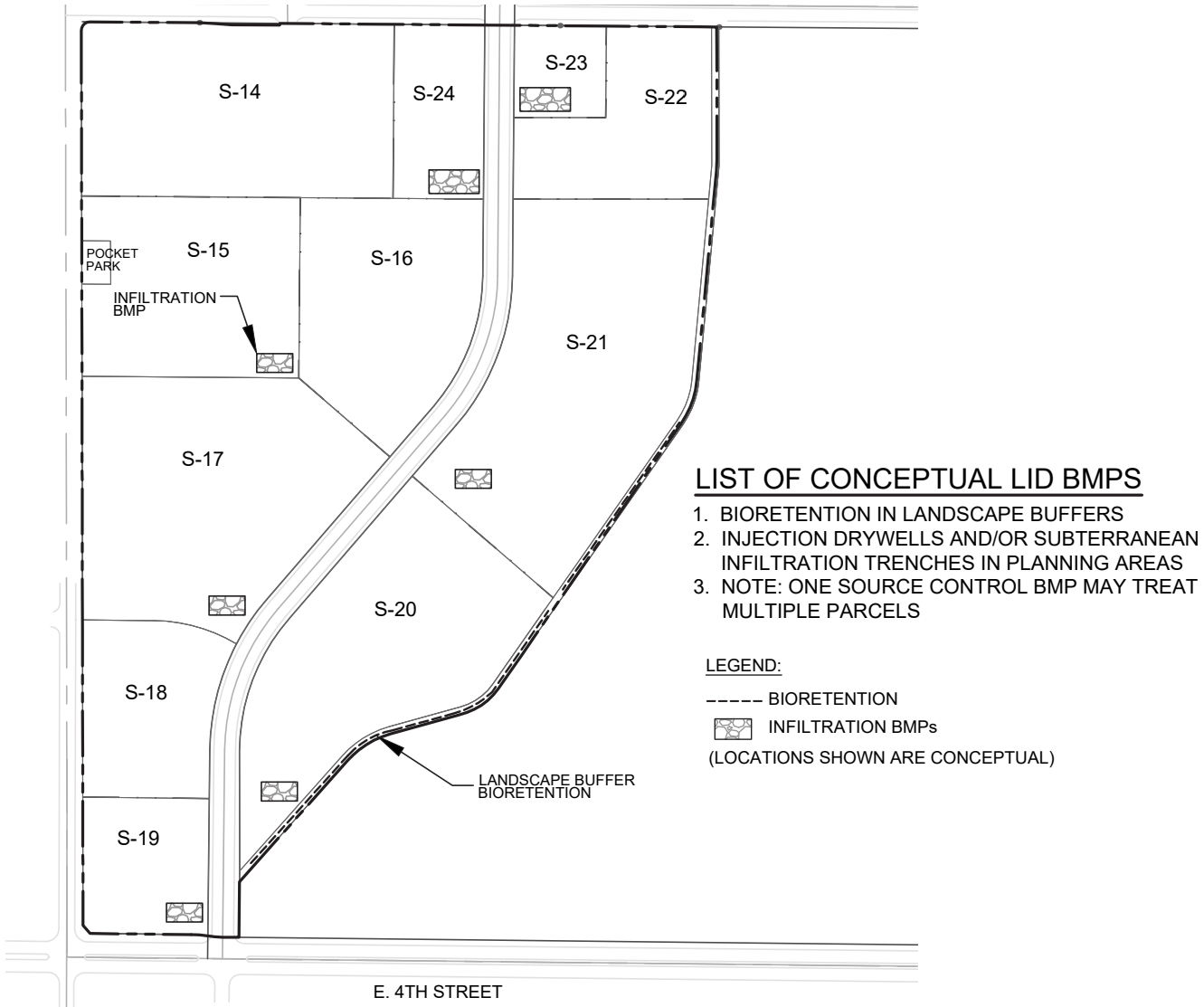

Figure A-11: Conceptual Storm Water Quality Management Plan

Note: Figure not to scale.



4.0 Sanitary Sewer

Peak sewer demands are calculated for each planning area based on standards established by the Cucamonga Valley Water District (CVWD). CVWD has an existing network of sewer pipelines in the vicinity with adequate excess capacity, and therefore off-site sewer line improvements are limited to short adjacent connections. The existing wastewater treatment plant (WWTP) currently has excess capacity. Therefore PAI will not need to contribute to the upsizing of any off-site facilities. CVWD management has indicated that the sewer pipelines which PAI sewer system will connect to have adequate capacity, as does the downstream WWTP.

Detailed plans for nonresidential uses are not yet available so it is not feasible to determine the plumbing (sewer drainage) fixture unit count required to estimate flows from the transit mixed-use commercial areas. For preliminary estimating purposes, a high-intensity loading factor (restaurant) for the County Sanitation District No. 21 of Los Angeles County was utilized. Sewage flow for the proposed common facilities, including restrooms in the parks, and the community building, was estimated based on the County Sanitation District factor for Parks. Because the exact nature of recreational facilities and improvements is not known, the factor is conservatively applied to the full planning area. The specific plan provides for a range in dwelling units for each planning area, but limits the total possible dwelling units to a level below a basic summation of the maximums. Therefore, the hydraulic calculations have a higher peak flow, because it cannot be determined precisely how many units will be developed in any planning area, so the maximums are used for all.

A system of sewer main pipelines will be installed throughout PAI, with larger lines serving as the backbone infrastructure, which in turn will serve smaller local sewer lines distributed throughout the various planning areas. The Sanitary Sewer system will be constructed in three (3) phases. Phase 1 sewer will extend from 4th Street northerly in the Vine to 6th Street. Refer to "Figure A-12: Conceptual Phase 1 Sanitary Sewer Facilities Plan". Phase 2 sewer will continue north in the Vine and extend along the frontages of Planning Areas N-10 and N-13 in 7th Street East and West. Refer to "Figure A-13: Conceptual Phase 2 Sanitary Sewer Facilities Plan". Phase 3 sewer will be constructed northerly in the Vine to Planning Area N-3 and within 7th Street West. Refer to "Figure A-14: Conceptual Phase 3 Sanitary Sewer Facilities Plan". Calculations were made to size pipes which range from 8 inches up to 15 inches. There will be multiple points of connection for PAI sewers. A portion of the northwesterly area of PAI will connect to an existing sewer in Seventh Street at Cleveland Avenue. The balance of PAI will sewer to the existing 21-inch line in 4th Street at the south end of the site. No additional off-site improvements are anticipated.

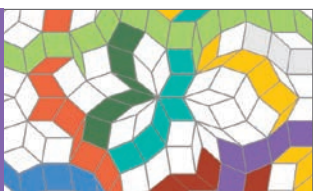

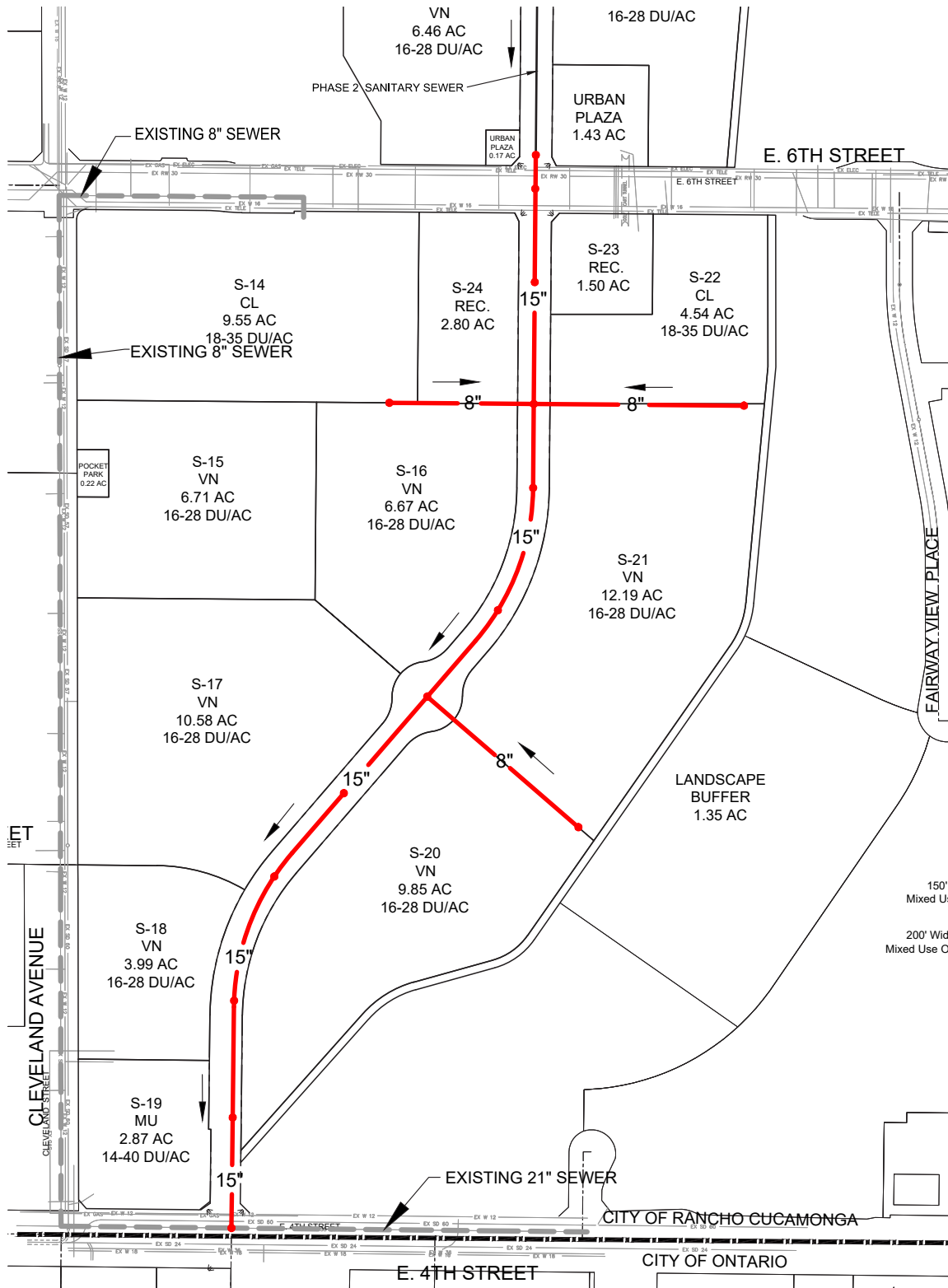

Figure A-12: Conceptual Phase 1 Sanitary Sewer Facilities Plan

LEGEND:

- 8" PROPOSED SANITARY SEWER - DIA.
- - - EXISTING SANITARY SEWER - DIA.
- DIRECTION OF FLOW

Note: Figure not to scale.



PAGE INTENTIONALLY LEFT BLANK

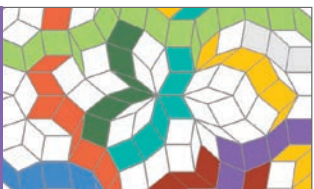



PAGE INTENTIONALLY LEFT BLANK

5.0 Domestic Water

Peak water demands are calculated for each planning area based on standards established by CVWD. Common area landscaping will be irrigated with recycled water. CVWD has an existing network of water pipelines in the vicinity of PAI with adequate excess capacity, and therefore off-site waterline improvements are limited to short adjacent connections. The existing supply network of imported water plus local surface and groundwater currently provides excess capacity, therefore PAI development will not need to contribute to the upsizing of any off-site facilities or secure additional sources of water supply. CVWD management has confirmed that the water pipelines which PAI development will connect to have adequate capacity, and that CVWD has excess storage and supply reserves sufficient to serve PAI.

In July 2011, CVWD issued the final 2010 Urban Water Management Plan (UWMP), as required by state law. The purpose of the UWMP is to demonstrate the ability for CVWD to provide potable water to all customers in the service area, and to provide a projection for future system supplies and demands to meet anticipated needs for the next 20 years or more. As detailed in the UWMP, CVWD acquires over 50% of the total supply from imported water provided by the Metropolitan Water District of Southern California (MWD), about 40% from groundwater, with the balance from surface water and recycled water.

Section 4.9 of the UWMP summarizes the current and projected water supplies, with over 50,000 acre-feet per year in 2010, and past 74,000 acre-feet per year by 2035. Current and projected water demand is summarized in Section 3.1 of the UWMP. Demand in 2010 was 48,000 acre-feet per year, and will rise to a projected 61,900 acre-feet per year by 2035. Therefore, CVWD projects that there will be excess capacity for the current and forecasted system demands.

PAI water demand is established based on the unit water demand from Section 3.4 of the UWMP, which is 252 gallons per capita per day. However, per CVWD, over 60% of water demand is outdoors, and with landscape irrigation being supplied with recycled water, the demand rate is only 101 gallons per capita per day. Per the 2010 US Census, the City of Rancho Cucamonga has an average of 2.99 persons per household. Persons per unit of multifamily are less than single-family, however that specific data is not available, and therefore the 2.99 persons per capita will be used. Therefore, PAI development is estimated to have a water demand of 302 gallons per dwelling unit per day. Because detailed plans for nonresidential uses are not part of the specific plan, it is not feasible to determine the plumbing fixture unit count required to estimate demand from

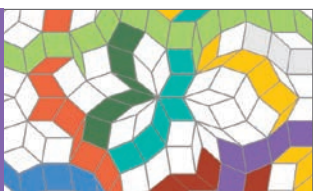

the transit mixed use commercial areas. For preliminary estimating purposes, demand data for County Sanitation District No. 21 of Los Angeles County was utilized. As recycled water will be used for irrigation, water demand is assumed to be equal to sewer loading. Because the specific plan does not place restrictions on the type of potential uses, a high-intensity factor is used in the calculations (restaurant). Water demand for the proposed common facilities, including restrooms in the parks, and the community building, was estimated based on the County Sanitation District factor for Parks. Because the exact nature of recreational facilities and improvements is not known, the factor is conservatively applied to the full planning area. Common area landscape irrigation is not included in the potable water calculations, as those areas will be served by the Recycled Water System. Calculations were made to determine the impact PAI development will have on the existing water system. The specific plan provides for a range in dwelling units for each planning area, but limits the total possible dwelling units to a level below a basic summation of the maximums. Therefore, the hydraulic calculations have a higher peak flow, because it cannot be determined precisely how many units will be developed in any planning area, so the maximums are used for all.

Water storage is necessary for the successful operation of a water system for a number of reasons. The various pressure zones are established based primarily on the average elevations in the connected reservoirs. The water storage also provides a buffer between the average water demand and the peak demand, as well as a reserve supply for emergencies, for example when a source of water is temporarily damaged or cut-off. The reservoirs also provide additional water for firefighting efforts. According to CVWD, there is sufficient excess storage capacity to serve PAI development.

A system of water main pipelines are proposed to be installed throughout PAI, with a transmission system proposed in the major streets, which in turn will serve local waterlines distributed throughout the various planning areas. Four points of connection to the existing CVWD domestic water system are proposed. The Domestic Water System will be constructed in three (3) phases. Phase 1 will consist of water distribution mains installed between 4th Street and 6th Street to serve all Planning Areas south of 6th Street. Phase 1 will connect to an existing 12-inch water main in 4th Street and an existing 16-inch water main in 6th Street. Phase 1 could have additional connections

to an existing 12-inch water main in Cleveland Avenue. Phase 2 will consist of water distribution mains installed in the Vine between 6th Street and 7th Street and in 7th Street East and West. Refer to “Figure A-15: Conceptual Phase 1 Domestic Water Facilities Plan”. Phase 2 will connect to the existing 16-inch water main in 6th Street and existing 12-inch water mains in 7th Street East and West. Refer to “Figure A-16: Conceptual Phase 2 Domestic Water Facilities Plan”. Phase 3 will consist of water distribution mains in the Vine extending from 7th Street to Planning Area N-3. Refer to “Figure A-17: Conceptual Phase 3 Domestic Water Facilities Plan”.

Based on the preliminary hydraulic analysis, an 8-inch backbone infrastructure system should be adequate in most reaches, with some 10-inch segments needed to accommodate fire flows in the lowest pressure areas. CWVD has not identified any system deficiencies in the area. Therefore no off-site pipeline improvements are anticipated, other than the adjacent system connections.

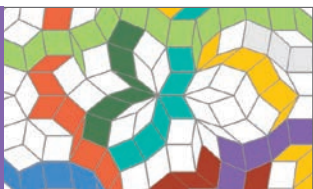

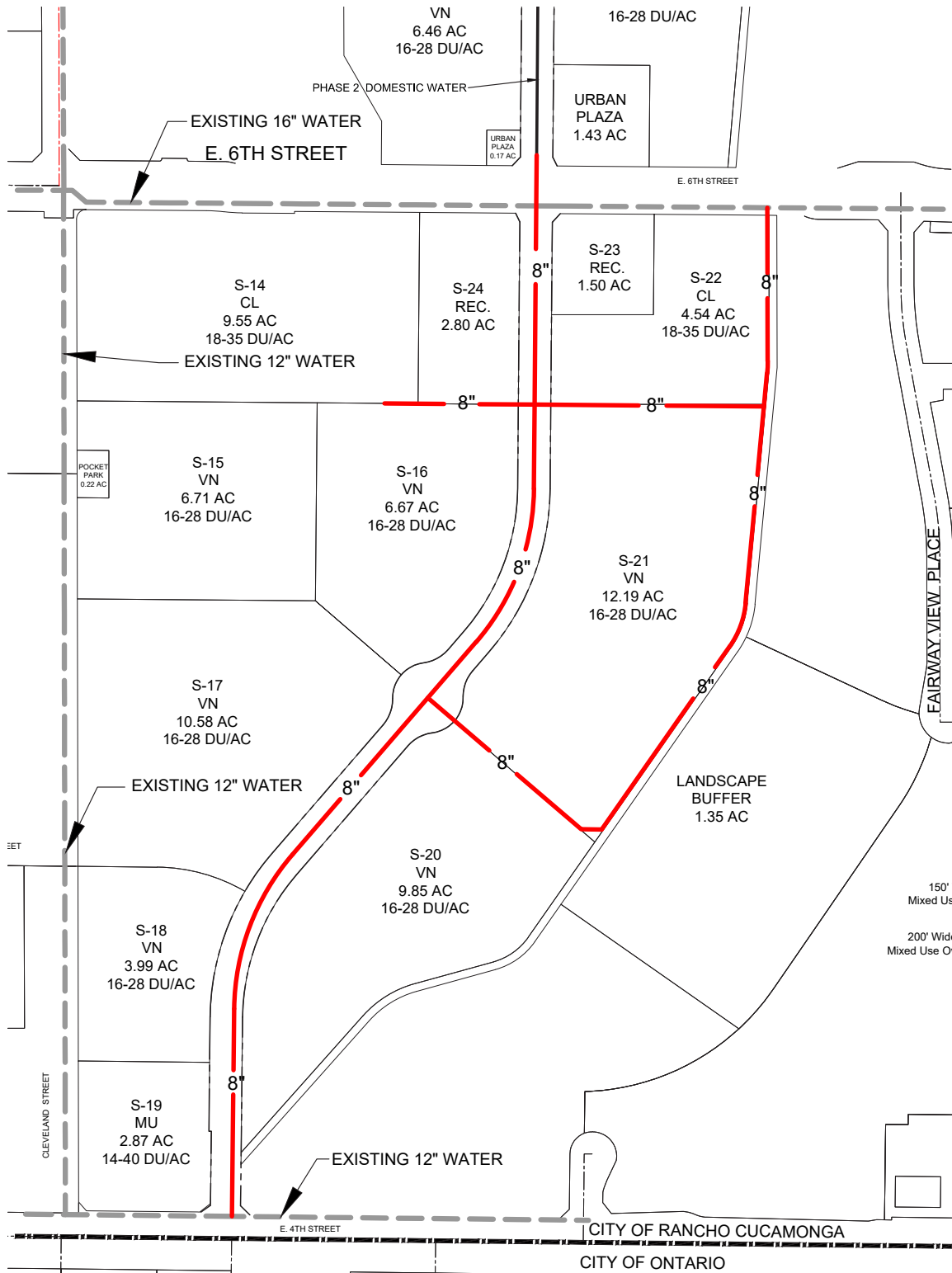

Figure A-15: Conceptual Phase 1 Domestic Water Facilities Plan

LEGEND:

- 8" PROPOSED DOMESTIC - DIA.
- EXISTING DOMESTIC WATER

Note: Figure not to scale.



PAGE INTENTIONALLY LEFT BLANK

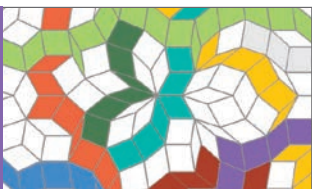



PAGE INTENTIONALLY LEFT BLANK

6.0 Recycled Water

Peak recycled water demands are calculated for each planning area based on standards established by the CVWD. Domestic water will be provided by CVWD and is discussed previously. CVWD has an existing network of recycled water pipelines in the vicinity of the project with adequate excess capacity, and therefore off-site recycled waterline improvements are limited to short adjacent connections. The existing supply network of recycled water currently provides excess capacity. Therefore the project will not need to contribute to the upsizing of any off-site facilities.

CVWD management indicated that the recycled water pipelines which the project will connect to have adequate capacity to serve the project.

Recycled water will be used for irrigation of common area landscaping throughout the project. This includes landscaped areas around the multifamily residential properties. A range of irrigation demand from 170,000 up to 220,000 gallons per acre per year is estimated for the maximum demand to be utilized, which translates to 603 gallons per day per acre. It is assumed that irrigation for a given planning area will occur evenly throughout an eight-hour period, restricted in time between 9 pm and 6 am. A peaking factor is applied to the average daily demand (ADD) of 2.0 for the Maximum Day Demand (MDD). Estimates for each landscape area and demand for each parcel were made, with assumptions for the relative level of required irrigation, depending on the anticipated planting design. Residential areas are assumed to have 20% landscape coverage. Estimates are also made for the parks, plazas, and paseos.

Per CVWD, there are sufficient rights to recycled water such that new sources of recycled water supply are not required for this project. CVWD has an extensive existing recycled water system, including pipelines, wells, pumps, pressure reducing valves, and storage reservoirs. CVWD's system is currently split into multiple pressure zones. When construction improvement plans are available, CVWD can incorporate the project system into the district-wide system in order to assess the impact, however per discussions with CVWD management, there are no anticipated deficiencies.

The recycled water main system will be constructed in three (3) phases. Phase 1 will include a transmission line in the Vine, connecting to a 30-inch IEUA recycled water main in 6th Street and extending southerly to 4th Street along with local feeder mains extending into Planning Areas. Refer to "Figure A-18: Conceptual Phase 1 Recycled Water Facilities Plan". Phase 2 will include transmission lines in the Vine between 6th Street and 7th Street, and in 7th Street East and West to serve local feeder mains extending into Planning Areas, with an additional connection to an existing 16-inch recycled water main in Cleveland Avenue. Refer to "Figure A-19: Conceptual Phase 2 Recycled Water Facilities Plan". Phase 3 will extend a transmission line northerly in the Vine to Planning Area N-3. Refer to "Figure A-20: Conceptual Phase 3 Recycled Water Facilities Plan".

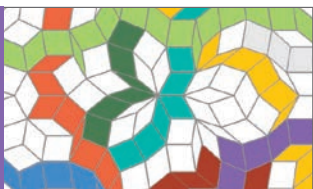

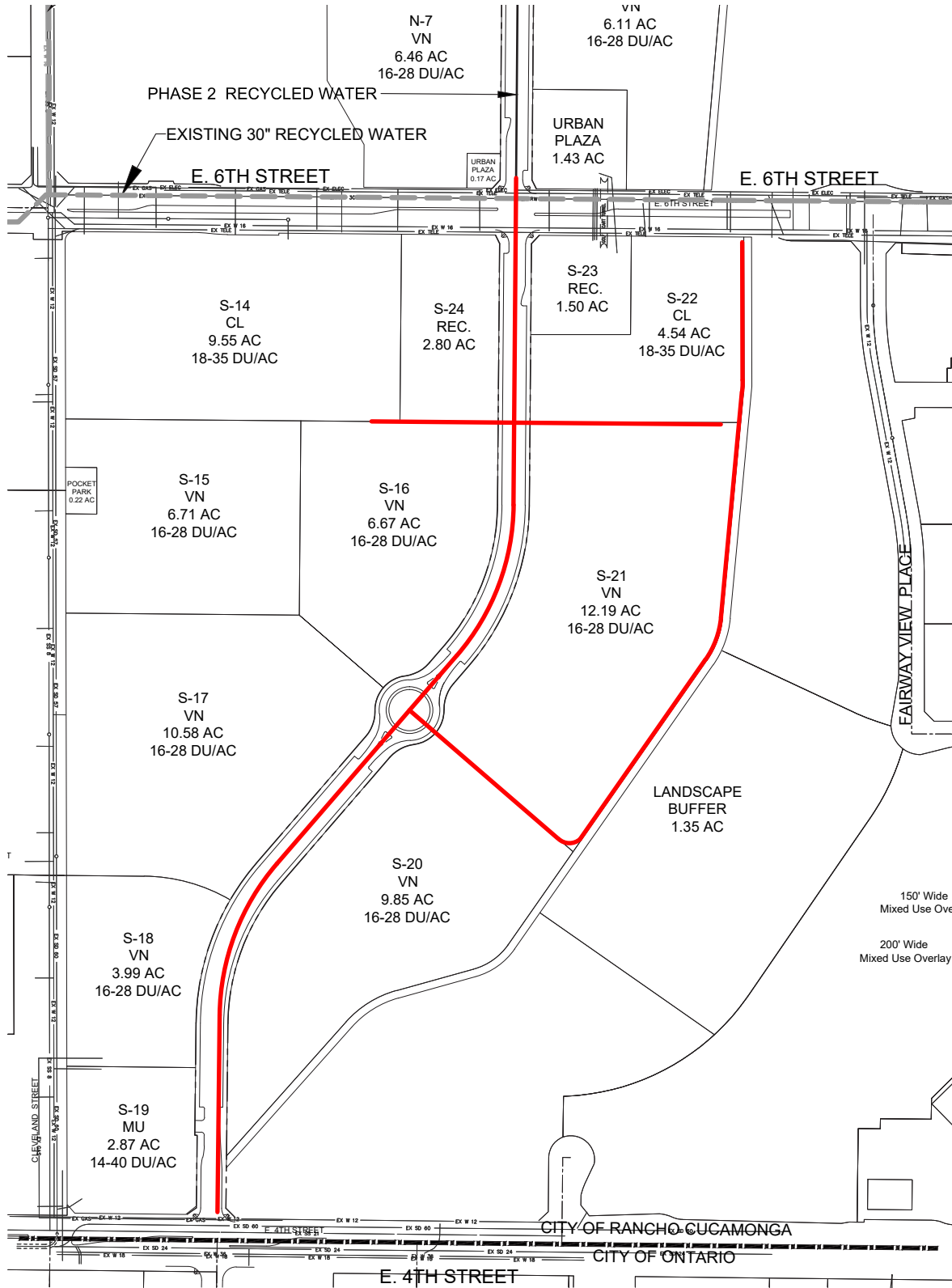

Figure A-18: Conceptual Phase 1 Recycled Water Facilities Plan

LEGEND:

- PROPOSED 8" RECYCLED WATER
- EXISTING RECYCLED WATER

Note: Figure not to scale.



PAGE INTENTIONALLY LEFT BLANK

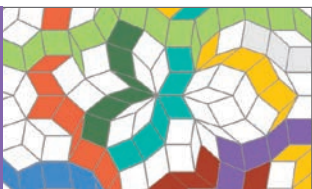



PAGE INTENTIONALLY LEFT BLANK

7.0 Street Improvement

Development of PAI will include street improvements to 4th Street and 6th Street, as well as the construction of the Vine and other Secondary roads. The street improvements will be constructed in three (3) phases. Phase 1 will include the following:

- Reconstruction of 4th Street median to provide for left turn movements into the Vine and the construction of the new intersection at the Vine;
- Construction of the Vine, full width, between 4th Street and 6th Street; and
- Reconstruction of 6th Street median to allow for left turn movements into the Vine and the construction of the new intersection at the Vine.

Phase 2 will include the following:

- Full width construction of the Vine between 6th Street and 7th Street East; and
- Construction of 7th Street East and West, including the reconstruction of existing knuckle designs at 7th Street and Cleveland Avenue and 7th Street and Anaheim Place.

It should be noted that additional right-of-way will be required from APN 0209-272-17 to extend 7th Street from Anaheim Place to the project boundary.

Phase 3 will include the following:

- Extension of the Vine northerly from 7th Street East to Planning Area N-3; and
- The Secondary road along the frontage of Planning Area N-3.

~~All Phases of the project should have connectivity to the Metrolink station in order to fulfill the intent of the project. To ensure access to the station from Phase 1 (while either Phases 2 and 3 are being graded and/or under construction, or are dormant due to market conditions) the construction of an access connection between 4th Street and the existing intersection of Anaheim Place and 7th Street near the Metrolink station, shall be completed prior to the 400th certificate of occupancy in Phase 1 to the satisfaction of the City.~~

~~This requirement may be satisfied north of 6th street with a temporary road condition with the following minimum features: 26-foot wide roadway with 3-inch AC over compacted native soil, asphalt curb and gutter, a 6.5-foot wide asphalt sidewalk on one side, temporary street lights (i.e. non City standard), and no landscaping in the alignment, all generally depicted on the "Figure A-22: Conceptual Phase 2 Street Improvement Facilities Plan" "Interim Access Connection." The access connection shall have chain link fencing on both sides~~

TEXT DELETED BY  SPECIFIC PLAN AMENDMENT

DRC 2020-00254

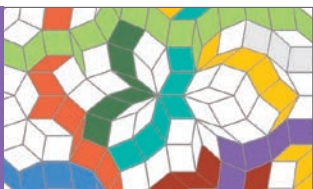

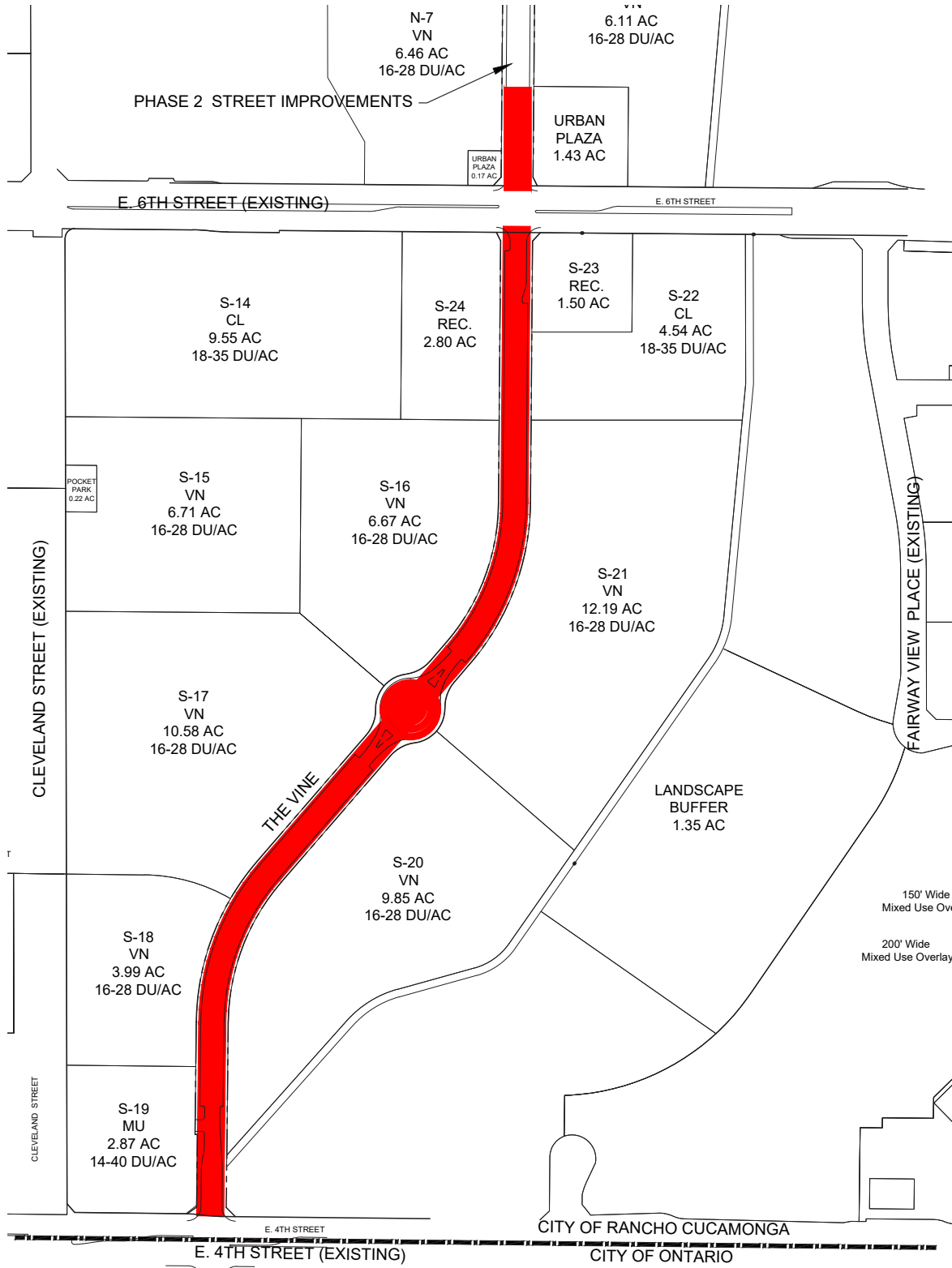

Figure A-21: Conceptual Phase 1 Street Improvement Facilities Plan

LEGEND:

PROPOSED STREET IMPROVEMENT

Note: Figure not to scale.



PAGE INTENTIONALLY LEFT BLANK

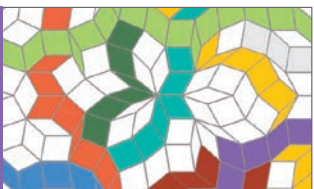



PAGE INTENTIONALLY LEFT BLANK

TEXT DELETED BY  SPECIFIC PLAN AMENDMENT

DRC 2020-00254

~~to protect against trespassing and vandalism on the adjacent property. The City shall accept a temporary easement and be responsible for liability. The Applicant shall be responsible for the ongoing operation and maintenance of the pavement and street lights. The City, to the extent allowed by law, shall restrict vehicles over 3 tons along the temporary access.~~

~~It is acknowledged by the City that the access connection may not be available during periods of construction of the permanent segments of the Vine and 7th Street, grading operations, and maintenance and repair of the access connector. Applicant and City will coordinate traffic control functions to insure delays are minimized. No additional alternative access facility will be required of Applicant during these down times. Traffic Control signs will direct traffic via detours to the next shortest available route off-site between Phase 1 (South of 6th) and the Rancho Cucamonga Metrolink Station.~~

8.0 Dry Utilities

PAI is within the service areas of the following utility purveyors:

Electricity: Rancho Cucamonga Municipal Utility (RCMU) will be the primary electric service provider.

Natural Gas: Southern California Gas Company

Telephone: Verizon

Cable Television: Charter Communications

Southern California Edison, Southern California Gas, Verizon, and Charter Communications have indicated that they have sufficient backbone facilities in place to provide for the phased and ultimate utility service demands of the project. Minor to moderate main line facility extensions will be required by the utility purveyors to ensure adequate service.

Charter Communications has a duct bank system along the south side of East 6th Street that has capacity to serve the development.

In addition, high-speed internet services may be available from RCMU.

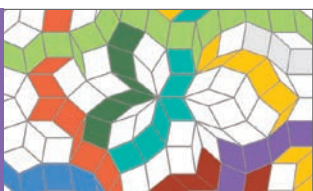

Appendix B Plant Palette

Prepared by:



Table B-1: Permitted Streetscape Tree List

Appropriate Use

Scientific Name	Common Name	Native	Tree Wells	4' + Planting Area Width	7' + Planting Area Width	RC Approved Street Tree
<i>Arbutus unedo</i>	Strawberry Tree			•		
<i>Arctostaphylos densiflora</i>	Vine Hill Manzanita	•	•	•		
<i>Brachychiton acerifolius</i>	Flame Tree		•	•		•
<i>Brachychiton populneus</i>	Bottle Tree		•	•		•
<i>Celtis sinensis</i>	Chinese Hackberry				•	•
<i>Chilopsis linearis ssp. Linearis</i>	Desert Willow	•		•		
<i>Chitalpa X tashkentensis</i>	Chitalpa			•		•
<i>Fraxinus angustifolia</i>	Narrowleaf Ash		•	•		•
<i>Fraxinus velutina</i>	Velvet Ash	•	•	•		
<i>Geijera parviflora</i>	Australian Willow		•	•		•
<i>Hymenosporum flavum</i>	Sweetshade			•		•
<i>Jacaranda mimosifolia</i>	Jacaranda				•	
<i>Koelreuteria paniculata</i>	Goldenrain Tree		•	•		•
<i>Lagerstroemia hybrid 'Muskogee'</i> ⁽¹⁾	Crape Myrtle			•	•	•
<i>Lagerstroemia hybrid 'Natchez'</i> ⁽²⁾	Crape Myrtle			•	•	•
<i>Lagunaria Patterson</i>	Primrose Tree				•	•
<i>Lyonothamnus floribundus</i>	Island Ironwood	•	•	•		•
<i>Magnolia grandiflora</i> ⁽²⁾	Bull Bay				•	•
<i>Melaleuca linariifolia</i>	Flaxleaf Paperbark		•	•		•
<i>Olea europaea</i>	Fruitless Olive				•	
<i>Olneya tesota</i>	Desert Ironwood	•	•	•		
<i>Parkinsonia x 'Desert Museum'</i>	Thornless Palo Verde	•	•	•		
<i>Phoenix canariensis</i>	Canary Island Date Palm		•	•		
<i>Phoenix dactylifera</i>	Date Palm		•	•		
<i>Pinus canariensis</i> ⁽¹⁾	Canary Island Pine				•	•
<i>Pinus eldarica</i>	Afghan Pine				•	•
<i>Pistachia chinensis</i>	Chinese Pistache		•	•		•
<i>Plantanus acerifolia 'Bloodgood'</i> ⁽¹⁾	London Planetree				•	•
<i>Platanus racemosa</i>	California Sycamore	•			•	•
<i>Podocarpus</i>	Yew Pine		•	•		•
<i>Populus fremontii</i>	Freemont Cottonwood	•			•	
<i>Prosopis glandulosa</i>	Mesquite	•	•	•		
<i>Quercus agrifolia</i>	Coast Live Oak	•			•	•
<i>Quercus douglasii</i>	Blue Oak	•			•	
<i>Quercus engelmannii</i>	Engelmann Oak	•			•	
<i>Quercus ilex</i>	Holly Oak		•	•		•
<i>Quercus lobata</i>	Valley Oak	•			•	
<i>Triadica sebiferum</i>	Chinese Tallow Tree				•	
<i>Washingtonia filifera</i>	California Fan Palm	•	•	•		

Notes:

⁽¹⁾ 4th Street designated tree

⁽²⁾ 6th Street designated tree

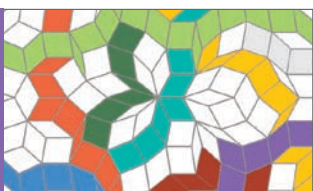

Table B-2: Permitted Plant List

Scientific Name	Common Name	Native	Plant Type
<i>Abies bracteata</i>	Santa Lucia Fir	•	tree
<i>Abies concolor</i>	White Fir	•	tree
<i>Abronia maritima</i>	Red Sand Verbena	•	low shrub/GC
<i>Abronia umbellata</i> ssp. <i>umbellata</i>	Pink Sand Verbena	•	low shrub/GC
<i>Abutilon palmeri</i>	Indian Mallow	•	shrub
<i>Acacia constricta</i>	White Thorn Acacia		shrub
<i>Acacia farnesiana</i>	Sweet Acacia		shrub
<i>Acacia greggii</i>	Catclaw Acacia	•	shrub
<i>Acacia redolens</i>	Desert Carpet		shrub
<i>Acacia stenophylla</i>	Shoestring Acacia		tree
<i>Acamptopappus sphaerocephalus</i> var. <i>hirtellus</i>	Rayless Goldenhead	•	shrub
<i>Acamptopappus sphaerocephalus</i> var. <i>sphaerocephalus</i>	Goldenhead	•	shrub
<i>Acer macrophyllum</i>	Big-leaf Maple	•	tree
<i>Acer negundo</i> var. <i>californicum</i>	California Box Elder	•	tree
<i>Achillea millefolium</i>	Common Yarrow	•	low shrub/GC
<i>Achnatherum coronatum</i>	Giant Stipa	•	grass
<i>Achnatherum hymenoides</i>	Rice Grass	•	grass
<i>Achnatherum speciosum</i>	Desert Needlegrass	•	grass
<i>Adenostoma fasciculatum</i>	Chamise	•	shrub
<i>Adolphia californica</i>	California Adolphia	•	shrub
<i>Aeonium</i> spp.			cactus/succulent
<i>Aesculus californica</i>	California Buckeye	•	tree
<i>Agave</i> spp.			cactus/succulent
<i>Agonis flexuosa</i>	Peppermint Tree		tree
<i>Albizia julibrissin</i>	Silk Tree		tree
<i>Aloe</i> spp.			cactus/succulent
<i>Alyogyne huegelii</i>	Blue Hibiscus		shrub
<i>Amelanchier utahensis</i>	Utah Service-Berry	•	shrub
<i>Amorpha californica</i> var. <i>californica</i>	California False-indigo	•	shrub
<i>Amorpha fruticosa</i>	Western False-indigo	•	shrub
<i>Antirrhinum coulterianum</i>	Coulter Snapdragon	•	shrub
<i>Arbutus marina</i>	Hybrid Strawberry Tree		tree
<i>Arbutus unedo</i>	Strawberry Tree		shrub
<i>Arbutus unedo</i>	Strawberry Tree		tree
<i>Arctostaphylos</i> spp.		•	shrub
<i>Argemone corymbosa</i>	Mojave Prickly-poppy	•	low shrub/GC
<i>Aristea ecklonii</i>	Blue Flies		low shrub/GC
<i>Aristida purpurea</i> var. <i>parishii</i>	Parish Three-awn	•	grass
<i>Armeria caespitosa</i>	Thrift		low shrub/GC

Table B-2: Permitted Plant List (continued)

Scientific Name	Common Name	Native	Plant Type
<i>Artemisia californica</i>	California Sagebrush	•	shrub
<i>Asclepias fascicularis</i>	Narrow-leaf Milkweed	•	shrub
<i>Aurinia saxatilis</i>	Basket of Gold		low shrub/GC
<i>Baccharis pilularis</i>	Coyote Brush	•	shrub
<i>Baccharis pilularis</i> 'Pigeon Point'	Prostrate Coyote Brush	•	low shrub/GC
<i>Baileya multiradiata</i>	Wild Marigold		low shrub/GC
<i>Berberis</i> [Mahonia] <i>aquifolium</i> var. <i>aquifolium</i>	Oregon Grape	•	shrub
<i>Berlandiera lyrata</i>	Chocolate Flower		low shrub/GC
<i>Bothriochloa barbinodis</i>	Beard Grass	•	grass
<i>Bougainvillea</i>	Bougainvillea		vine/espallier
<i>Bougainvillea</i>	Bougainvillea		low shrub/GC
<i>Bougainvillea</i>	Bougainvillea		shrub
<i>Brachychiton acerifolius</i>	Flame Tree		tree
<i>Brahea armata</i>	Mexican Blue Palm		palm
<i>Brahea brandegeei</i>	San Jose Hesper Palm		palm
<i>Brahea edulis</i>	Guadalupe Palm		palm
<i>Brahea elegans</i>	Franceschi Palm		palm
<i>Brickellia californica</i>	California Brickellbush	•	shrub
<i>Buddleia davidii</i>	Butterfly Bush		shrub
<i>Bulbine frutescens</i>	Yellow Bulbine		cactus/succulent
<i>Caesalpinia pulcherrima</i>	Red Bird of Paradise		shrub
<i>Calliandra californica</i>	Baja Fairy Duster	•	shrub
<i>Callistemon</i> 'Little John'	Little John Bottlebrush		shrub
<i>Calocedrus decurrens</i>	Incense Cedar	•	tree
<i>Calycanthus occidentalis</i>	Spice Bush	•	shrub
<i>Calystegia macrostegia</i>	So. California Morning Glory	•	vine/espallier
<i>Campsis radicans</i>	Trumpet vine/espallier		vine/espallier
<i>Capparis spinosa</i>	Caper		grass
<i>Carex barberae</i>	Santa Barbara Sedge		grass
<i>Carex pansa</i> (<i>praegacillis</i>)		•	grass
<i>Carex spissa</i>		•	grass
<i>Carissa macrocarpus</i>	Natal Plum		shrub
<i>Carpenteria californica</i>	Bush Anemone	•	shrub
<i>Cassia artemisioides</i>	Feathery cassia		shrub
<i>Cassia leptophylla</i>	Gold Medallion Tree		tree
<i>Ceanothus</i> spp.		•	shrub
<i>Ceratonia siliqua</i>	St. John's Beard		cactus/succulent
<i>Cercidium</i> 'Desert Museum'	Hybrid Palo Verde		tree
<i>Cercis occidentalis</i>	Western Redbud	•	tree
<i>Cercocarpus betuloides</i>	Mountain-Mahogany	•	shrub
<i>Chamaerops humilis</i>	Mediterranean Fan Palm		palm

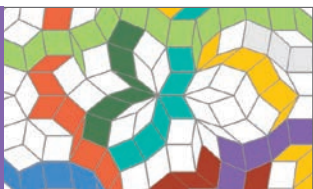

Table B-2: Permitted Plant List (continued)

Scientific Name	Common Name	Native	Plant Type
<i>Chilopsis linearis</i>	Desert Willow	•	tree
<i>Chitalpa X tashkentensis</i>	Chitalpa		tree
<i>Chrysothamnus nauseosus ssp. hololeucus</i>	Common Rabbitbrush	•	shrub
<i>Cistus x purpureus</i>	Orchid Rockrose		shrub
<i>Clematis ligusticifolia</i>	Virgin's Bower	•	vine/espallier
<i>Cleome isomeris [Isomeris arborea]</i>	Bladderpod	•	shrub
<i>Convolvulus cneorum</i>	Bush Morning Glory		shrub
<i>Coreopsis californica</i>	Californian Coreopsis	•	shrub
<i>Cornus nuttallii</i>	Mountain Dogwood	•	tree
<i>Cotinus obovatus</i>	American Smoketree		tree
<i>Cotoneaster</i>	Cotoneaster		shrub
<i>Cotoneaster microphyllus</i>	Rockspray Cotoneaster		low shrub/GC
<i>Cotyledon orbiculata</i>	Pig's Ear		cactus/succulent
<i>Crassula spp.</i>			cactus/succulent
<i>Cylindropuntia [Opuntia] echinocarpa</i>	Silver Cholla	•	cactus/succulent
<i>Cylindropuntia [Opuntia] prolifera</i>	Coast Cholla	•	cactus/succulent
<i>Cylindropuntia californica [Opuntia parryi]</i>	Cane Cholla	•	cactus/succulent
<i>Dasyliirion longissimum</i>	Grass Tree		cactus/succulent
<i>Dasyliirion quadrangulatum</i>	Mexican Grass Tree		cactus/succulent
<i>Dasyliirion wheeleri</i>	Desert Spoon		cactus/succulent
<i>Datura wrightii</i>	Jimson Weed	•	low shrub/GC
<i>Dendromecon harfordii</i>	Channel Island Tree Poppy	I	shrub
<i>Dianella caevulea</i>	cassa blue		grass
<i>Dianella revoluta</i>	little rev		grass
<i>Diplacus [Mimulus] aurantiacus</i>	Sticky Monkeyflower	•	shrub
<i>Dodonaea viscosa</i>	Hopseed bush		shrub
<i>Dracaena spp.</i>			tree
<i>Dracaena spp.</i>			shrub
<i>Dudlea spp.</i>	Dudlea	•	low shrub/GC
<i>Echeveria elegans</i>	Hen and Chicks		cactus/succulent
<i>Echinocactus</i>	Barrel cactus		cactus/succulent
<i>Echinocereus triglochidiatus</i>	Mojave Mound cactus	•	cactus/succulent
<i>Eriobotrya japonica</i>	Loquat		tree
<i>Eriogonum spp.</i>		•	shrub
<i>Eriophyllum confertiflorum</i>	Golden Yarrow	•	shrub
<i>Erythrina spp.</i>	Coral Tree		tree
<i>Eschscholtzia californica</i>	Red Rock Poppy	•	low shrub/GC
<i>Escobaria vivipara</i>	Foxtail cactus	•	cactus/succulent
<i>Espostoa lanata</i>	Peruvian Old Man cactus		cactus/succulent
<i>Euphorbia antisiphilitica</i>	Candelilla		cactus/succulent
<i>Euphorbia characias</i>	Mediterranean Spurge		shrub

Table B-2: Permitted Plant List (continued)

Scientific Name	Common Name	Native	Plant Type
<i>Euphorbia cyparissias</i>	Cypress Spurge		shrub
<i>Euphorbia dulcis</i>	Chameleon		shrub
<i>Euphorbia misera</i>	Cliff Spurge	•	shrub
<i>Euphorbia rigida</i>	Gopher Plant		shrub
<i>Euphorbia seguieriana niciana</i>	Blue Haze		shrub
<i>Euphorbia x martinii</i>	Spurge Hybrid		shrub
<i>Euryops pectinatus veridis</i>	Green Euryops Daisy		shrub
<i>Ferocactus/succulent cylindraceus</i>	Barrel cactus/succulent	•	cactus/succulent
<i>Ficus benjamina</i>	Weeping Chinese Banyan		tree
<i>Forestiera pubescens</i>	Desert Olive	•	shrub
<i>Fouquieria splendens</i>	Ocotillo		cactus/succulent
<i>Fragaria vesca [californica]</i>	California Strawberry	•	low shrub/GC
<i>Fraxinus angustifolia</i>	Narrowleaf Ash		tree
<i>Fraxinus velutina</i>	Velvet Ash	•	tree
<i>Fremontodendron californicum</i>	California Flannelbush	•	shrub
<i>Galvezia speciosa</i>	Island Bush Snapdragon	•	shrub
<i>Geijera parviflora</i>	Australian Willow		tree
<i>Gelsemium sempervirens</i>	Carolina Jessamine		vine/espallier
<i>Grevillea asplenifolia</i>	Grevillea		shrub
<i>Grevillea australis</i>	Alpine Grevillea		shrub
<i>Grevillea banksii</i>	Grevillea		shrub
<i>Grevillea curviloba</i>	Grevillea		shrub
<i>Grevillea lanigera</i>	Woolly Grevillea		shrub
<i>Grevillea lavadulacea</i>	Lavender Grevillea		shrub
<i>Grevillea rosmarinifolia</i>	Rosemary Grevillea		shrub
<i>Grevillea thelemanniana</i>	Hummingbird Bush		shrub
<i>Grevillea victoriae</i>	Grevillea		shrub
<i>Grevillea x gaudichaudii</i>	Grevillea Hybrid		shrub
<i>Hardenbergia comptoniana</i>	Lilac vine		vine/espallier
<i>Hardenbergia violacea</i>	Lilac vine		vine/espallier
<i>Hesperaloe funifera</i>	Giant Hesperaloe		cactus/succulent
<i>Hesperaloe parvifolia</i>	Red Hesperaloe		cactus/succulent
<i>Hesperoyucca [Yucca] whipplei</i>	Chaparral Yucca	•	cactus/succulent
<i>Heteromeles arbutifolia</i>	Toyon	•	shrub/tree
<i>Heuchera spp.</i>			low shrub/GC
<i>Hymenosporum flavum</i>	Sweetshade		tree
<i>Iris douglasiana</i>	Douglas Iris	•	low shrub/GC
<i>Jacaranda mimosifolia</i>	Jacaranda		tree
<i>Juglans californica</i>	Southern California Black Walnut	•	tree
<i>Juniperus californica</i>	California Juniper	•	shrub/tree

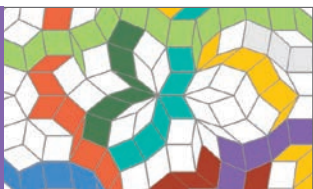

Table B-2: Permitted Plant List (continued)

Scientific Name	Common Name	Native	Plant Type
<i>Justicia brandegeana</i>	Shrimp Plant		shrub
<i>Keckiella antirrhinoides</i>	Chaparral Beard-Tongue	•	shrub
<i>Keckiella breviflora</i>	Gaping Keckiella	•	shrub
<i>Keckiella cordifolia</i>	Heart-leaved Keckiella	•	shrub
<i>Koelreuteria paniculata</i>	Goldenrain Tree		tree
<i>Lagerstroemia</i> hybrid 'Muskogee'	Crape Myrtle		tree
<i>Lagerstroemia</i> hybrid 'Muskogee'	Crape Myrtle		tree
<i>Laurus nobilis</i>	Sweet Bay		Shrub
<i>Lavatera assurgentiflora</i>	Island Tree Mallow		shrub
<i>Layia glandulosa</i>	Desert Tidy Tips	•	low shrub/GC
<i>Layia heterotricha</i>	Pale-yellow Layia	•	low shrub/GC
<i>Layia platyglossa</i>	Tidy tips	•	low shrub/GC
<i>Leonotis leonurus</i>	Lion's Tail		shrub
<i>Lepechinia calycina</i>	White Pitcher Sage	•	shrub
<i>Lepechinia fragrans</i>	Fragrant Pitcher Sage	•	shrub
<i>Lepechinia hastata</i>	Pitcher Sage		shrub
<i>Leucadendron argenteum</i>	Silver Tree		tree
<i>Leucadendron discolor</i>	Flametip		shrub
<i>Leucadendron tinctum</i>	Spicy Conebush		shrub
<i>Leucospermum</i> spp.			shrub
<i>Leymus condensatus</i> 'Canyon Prince'	Canyon Prince Wild Rye	•	grass
<i>Lonicera subspicata</i> var. <i>denudata</i>	Johnston's Honeysuckle	•	low shrub/GC
<i>Lyonothamnus floribundus</i>	Island Ironwood	•	tree
<i>Lysiloma microphylla thornberi</i>	Feather Bush		shrub
<i>Macfadyena unguis-cati</i>	Cat Claw vine/espallier		vine/espallier
<i>Magnolia grandiflora</i>	Bull Bay		tree
<i>Malacothamnus densiflorus</i>	Bush Mallow	•	shrub
<i>Malosma laurina</i>	Laurel Sumac	•	shrub
<i>Mascagnia lilacina</i>	Lavender Orchid vine		vine/espallier
<i>Mascagnia macroptera</i>	Yellow Orchid vine		vine/espallier
<i>Melaleuca</i> spp.			shrub
<i>Mimulus [Diplacus] aurantiacus</i>	Sticky Monkeyflower	•	shrub
<i>Mirabilis laevis</i> var. <i>crassifolia</i>	Wishbone Bush	•	shrub
<i>Monardella villosa</i>	Coyote Mint	•	perennial herb
<i>Muhlenbergia rigens</i>	Deer Grass	•	grass
<i>Myoporum parvifolium</i>	Myoporum		low shrub/GC
<i>Myrica californica</i>	California Wax-myrtle	•	shrub
<i>Myrsine africana</i>	African Boxwood		shrub
<i>Nassella pulchra</i>	Purple Needlegrass	•	grass
<i>Nolina recurvata</i>	Bottle Palm		cactus/succulent
<i>Oenothera californica</i>	California Evening-Primrose	•	low shrub/GC

Table B-2: Permitted Plant List (continued)

Scientific Name	Common Name	Native	Plant Type
<i>Olea europaea</i>	Fruitless Olive		tree
<i>Olneya tesota</i>	Desert Ironwood		tree
<i>Opuntia</i> spp.		•	cactus/succulent
<i>Pandorea pandorana</i>	Wonga-wonga		vine/espallier
<i>Parkinsonia</i> x 'Desert Museum'	Thornless Palo Verde	•	tree
<i>Parthenocissus tricuspidata</i>	Boston Ivy		vine/espallier
<i>Pedilanthus macrocarpus</i>	Lady's Slipper		cactus/succulent
<i>Pellaea andromedifolia</i>	Coffee shrub	•	shrub
<i>Penstemon heterophyllus</i> 'Margarita BOP'	Foothill Penstemon	•	perennial herb
<i>Penstemon spectabilis</i>	Showy Penstemon	•	perennial herb
<i>Philadelphus lewisii</i>	Mock Orange	•	shrub
<i>Phlomis</i> spp.			shrub
<i>Phoenix canariensis</i>	Canary Island Date Palm		palm
<i>Phoenix dactylifera</i>	Date Palm		palm
<i>Phormium</i> spp.	Flax		shrub
<i>Photinia</i> x 'Fraseri'	Fraser's Photinia		shrub
<i>Pinus attenuata</i>	Knobcone Pine	•	tree
<i>Pinus canariensis</i>	Canary Island Pine		tree
<i>Pinus sabiniana</i>	Digger Pine	•	tree
<i>Pinus torreyana</i>	Torrey Pine	•	tree
<i>Pistachia chinensis</i>	Chinese Pistache		tree
<i>Plagiobothrys</i> spp.	Popcorn Flower	•	low shrub/GC
<i>Platanus acerfolia</i>	London Planetree		tree
<i>Platanus racemosa</i>	California Sycamore	•	tree
<i>Plecostachys serpyllifolia</i>	Licorice Plant		shrub
<i>Podocarpus</i>	Yew Pine		tree
<i>Polypodium californicum</i>	California Polypody	•	shrub
<i>Populus fremontii</i>	Freemont cottonwood	•	tree
<i>Portulacaria afra</i>	Elephant's Food		cactus/succulent
<i>Prosopis glandulosa</i> 'Phoenix'	Phoenix Honey Mesquite	•	tree
<i>Protea</i> spp.			shrub
<i>Prunus ilicifolia</i>	Holly-Leaved Cherry	•	tree
<i>Prunus virginiana</i>	Western Choke-Cherry	•	tree
<i>Pseudotsuga macrocarpa</i>	Bigcone Douglas-fir	•	tree
<i>Punica granatum</i>	Pomegranate		shrub
<i>Purshia mexicana</i>	Cliff Rose		shrub
<i>Puya berteroniana</i>	Puya		cactus/succulent
<i>Pyracantha crenatoserrata</i>	Firethorn		shrub
<i>Pyrostegia venusta</i>	Flame vine		vine/espallier
<i>Pyrrosia lingua</i>	Japanese Felt shrub		shrub
<i>Quercus agrifolia</i> var. <i>agrifolia</i>	Coast Live Oak	•	tree



Table B-2: Permitted Plant List (continued)

Scientific Name	Common Name	Native	Plant Type
<i>Quercus berberidifolia</i>	Scrub Oak	•	tree
<i>Quercus chrysolepis</i>	Canyon Oak	•	tree
<i>Quercus chrysolepis</i>	Canyon Live Oak	•	tree
<i>Quercus douglasii</i>	Blue Oak	•	tree
<i>Quercus dumosa</i>	Nuttall's Scrub Oak	•	shrub
<i>Quercus engelmannii</i>	Engelmann Oak	•	tree
<i>Quercus garryana</i> var. <i>breweri</i>	Brewer's Oak	•	tree
<i>Quercus ilex</i>	Holly Oak		tree
<i>Quercus kelloggii</i>	Black Oak	•	tree
<i>Quercus lobata</i>	Valley Oak	•	tree
<i>Quercus tomentella</i>	Island Oak	•	tree
<i>Raoulia australis</i>	Saxon's Pass		low shrub/GC
<i>Ratibida columnifera</i>	Mexican Hat		low shrub/GC
<i>Rhamnus californica</i>	California Coffeeberry	•	shrub
<i>Rhamnus crocea</i>	Redberry	•	shrub
<i>Rhamnus ilicifolia</i>	Hollyleaf Redberry	•	shrub
<i>Rhamnus tomentella</i>	Hoary Coffeeberry	•	shrub
<i>Rhamnus tomentella</i> ssp. <i>cuspidata</i>	Hoary Coffeeberry	•	shrub
<i>Rhus integrifolia</i>	Lemonade Berry	•	shrub
<i>Rhus lancea</i>	African Sumac		tree
<i>Rhus laurina</i>	Laurel Sumac	•	shrub
<i>Rhus ovata</i>	Sugar Bush	•	shrub
<i>Ribes</i> spp.		•	shrub
<i>Robinia neomexicana</i>	Desert Locust		tree
<i>Robinia x ambigua</i>	Locust		tree
<i>Romneya coulteri</i>	Coulter's Matilija Poppy	•	shrub
<i>Rosa californica</i>	California Wild Rose	•	shrub
<i>Rosemarinus officinalis prostratus</i>	Dwarf Rosemary		low shrub/GC
<i>Rosmarinus officinalis</i>	Rosemary		shrub
<i>Rubus ursinus</i>	California blackberry	•	vine/espallier
<i>Salvia apiana</i>	White Sage	•	shrub
<i>Salvia clevelandii</i>	Cleveland Sage		shrub
<i>Salvia leucophylla</i>	Purple Sage	•	shrub
<i>Salvia mellifera</i>	Black Sage	•	shrub
<i>Salvia spathacea</i>	Hummingbird Sage	•	perennial herb
<i>Sambucus mexicana</i>	Mexican Elderberry	•	shrub
<i>Sansevieria trifasciata</i>	Bowstring Hemp		cactus/succulent
<i>Santolina virens</i>	Green Santolina		shrub
<i>Sapium sebiferum</i>	Chinese Tallow Tree		tree
<i>Satureja douglasii</i>	Yerba Buena	•	perennial herb
<i>Schinus molle</i>	California Pepper		tree

Table B-2: Permitted Plant List (continued)

Scientific Name	Common Name	Native	Plant Type
<i>Scirpus</i> spp.	Tule	•	grass
<i>Sedum</i> spp.			low shrub/GC
<i>Sempervivum arachnoideum</i>	Cobweb Houseleek		low shrub/GC
<i>Sempervivum tectorum</i>	Hen and Chicks		low shrub/GC
<i>Senna surattensis</i>	Scrambled Eggs		tree
<i>Sidalcea malviflora</i>	Dwarf Checkerbloom	•	low shrub/GC
<i>Simmondsia chinensis</i>	Joboba		shrub
<i>Sisyrinchium bellum</i>	Blue-Eyed-Grass	•	low shrub/GC
<i>Solanum douglasii</i>	Douglas's Nightshade	•	low shrub/GC
<i>Solanum umbelliferum</i>	Blue Witch	•	shrub
<i>Solanum wallacei</i>	Catalina Nightshade	•	shrub
<i>Solanum xanti</i>	Purple Nightshade	•	shrub
<i>Solidago rugosa</i>	Fireworks		shrub
<i>Solidago sphacelata</i>	Golden Fleece		shrub
<i>Sophora secundiflora</i>	Mescal Bean		tree
<i>Spathodea campanulata</i>	African Tulip Tree		tree
<i>Sphaeralcea ambigua</i>	Rose Apricot Mallow	•	shrub
<i>Stachys byzantina</i>	Lamb's Ears		low shrub/GC
<i>Stanleya pinnata</i> var. <i>pinnata</i>	Prince's Plume	•	shrub
<i>Stenocereus thurberi</i>	Organpipe		cactus/succulent
<i>Symphoricarpos albus</i> var. <i>laevigatus</i>	Common Snowberry	•	shrub
<i>Symphoricarpos mollis</i>	Trailing Snowberry	•	low shrub/GC
<i>Tecoma stans</i>	Yellow Bells		shrub
<i>Teucrium cossonii</i> <i>majoricum</i>	Germander		low shrub/GC
<i>Thymus camphoratus</i>	Camphor Thyme		low shrub/GC
<i>Thymus herba-barona</i>	Caraway-scented Thyme		low shrub/GC
<i>Thymus pseudolanuginosus</i>	Woolly Thyme		low shrub/GC
<i>Thymus pulegioides</i>	Thyme		low shrub/GC
<i>Thymus serpyllum</i>	Mother-of-Thyme		low shrub/GC
<i>Thymus vulgaris</i>	Common Thyme		low shrub/GC
<i>Thymus x citriodorus</i>	Lemon Thyme		low shrub/GC
<i>Trichostema lanatum</i>	Woolly Bluecurls	•	shrub
<i>Typha</i> spp.	Monocot cattails	•	shrub
<i>Umbellularia californica</i>	California Bay	•	shrub
<i>Venegasia carpesioides</i>	Canyon Sunflower	•	shrub
<i>Verbena</i> spp.			low shrub/GC
<i>Viguiera laciniata</i>	San Diego Sunflower	•	shrub
<i>Viguiera stenoloba</i>	Skeleton Leaf Golden Eye		shrub
<i>Vitis californica</i>	California Wild Grape	•	vine/espallier
<i>Washingtonia filifera</i>	California Fan Palm	•	palm
<i>Westringia fruticosa</i>	Coast Rosemary		shrub



Table B-2: Permitted Plant List (continued)

Scientific Name	Common Name	Native	Plant Type
<i>Wisteria floribunda</i>	Japanese Wisteria		vine/espallier
<i>Wisteria sinensis</i>	Chinese Wisteria		vine/espallier
<i>Xanthorrhoea preisii</i>	Grass Tree		cactus/succulent
<i>Xanthorrhoea quadrangulata</i>	Grass Tree		cactus/succulent
<i>Xylosmo congestum</i>	Shiny Xylosmo		shrub
<i>Yucca spp.</i>			cactus/succulent
<i>Zauschneria californica</i>	California Fuschia	•	low shrub/GC





Appendix C General Plan Amendment

Land Use

In Rancho Cucamonga, vacant land has become a scarce resource. Land use decisions must be carefully crafted to protect established residential neighborhoods and plan for appropriate infill development while connecting land uses and transportation modes. These key objectives provide the framework for the City's land use strategies.

Land use is a term that describes different types of activities that occur in a particular area. For example, some areas in Rancho Cucamonga contain homes while other areas contain stores, warehouses, parks, or schools. In some places, like Victoria Gardens, a mixture of uses creates an active and vital commercial and cultural center. This Land Use section describes the general location, type, and intensity of development throughout Rancho Cucamonga.

The maps, graphics, and text in this section also define the distribution, intensity, and preferred form of land uses within residential neighborhoods, along key corridors, and on specific sites. The Land Use Policy Map (Figure LU-1) presents a pictorial representation of land use policy. Cumulatively, these policies will shape future development to maintain and enhance all areas of Rancho Cucamonga.

Planning Context

The pattern of development within Rancho Cucamonga is characterized by essentially a north/south split roughly along Foothill Boulevard. The northern two-thirds of the City are predominately residential, while the southern third is largely industrial. Commercial centers are primarily clustered along Foothill Boulevard, Base Line Road, and several other major roadways. The northern edge of the Sphere of Influence is dominated by open space and hillside terrain. Table LU-1 identifies the land use distribution for the City and Sphere of Influence by general categories as of 2009.

Note: Table to be updated by City

Table LU-1: Land Use Distribution - 2009

Land Use	City Acres	Sphere of Influence Acres	Total Acres	Percent of Total
Residential	10,310	125	10,435	39.3%
Commercial	660	--	660	2.5%
Mixed Use	702	--	702	2.6%
Industrial	3,203	--	3,203	12.1%
Public Facilities	1,656	1,448	3,104	11.7%
Schools	536	--	536	2.0%
Parks	347	--	347	1.3%
Open Space and Conservation	707	1,186	1,893	7.1%
Vacant	2,503	3,168	5,671	21.4%
Total	20,624	5,927	26,551	100.0%

Source: Rancho Cucamonga GIS data, 2009.



Land Use Designations

- Residential**
 - Very Low (0.1 - 2.0 du/ac)
 - Low (2.0 - 4.0 du/ac)
 - Low Medium (4.0 - 8.0 du/ac)
 - Medium (8.0 - 14.0 du/ac)
 - Medium High (14.0 - 24.0 du/ac)
 - High (24.0 - 30.0 du/ac)
- Commercial**
 - Office (0.40 - 1.0 FAR)
 - Neighborhood Commercial (0.25 - 0.35 FAR)
 - Community Commercial (0.25 - 0.35 FAR)
 - General Commercial (0.25 - 0.35 FAR)
- Mixed Use**
 - Mixed Use (0.25 - 1.0 FAR)
- Industrial**
 - Industrial Park (0.40 - 0.60 FAR)
 - General Industrial (0.50 - 0.60 FAR)
 - Heavy Industrial (0.40 - 0.50 FAR)
- Open Space**
 - Hillside Residential (0.1 - 2.0 du/ac)
 - Conservation
 - Open Space (0 - 0.1 du/ac)
 - Flood Control/Utility Corridor
- Public Facility**
 - Civic/Regional (0.40 - 1.0 FAR)
 - Schools (0.10 - 0.20 FAR)
 - Parks
- Mixed Use Areas**
 - 1. Victoria Gardens
 - 2. Town Center (Foothill Blvd & Haven Ave)
 - 3. Terra Vista
 - 4. Hemosa Ave & Center Ave
 - 5. Foothill Blvd
 - 6. Foothill Blvd & Hillman Ave
 - 7. Foothill Blvd & Maylan Ave (Sub-Area 19)
 - 8. Foothill Blvd & Deer Creek Channel
 - 9. Foothill Blvd & Arrow St Site
 - 10. Western Gateway (Bear Gulch Area)
 - 11. Western Gateway
 - 12. Foothill Blvd-Cucamonga Channel Site
 - 13. Historic Alhambra (Hemosa Ave and Hampshire St)

- Overlays**
 - Haven Avenue Office
 - Equestrian/Rural Area
 - Master Plan
- Schools and Parks**
 - Elementary School
 - Junior High School
 - High School
 - College
 - Proposed Park (1)
- Base Layers**
 - Freeway
 - Roads
 - Sphere of Influence
 - Waterways

Note: (1) Location of proposed parks are not fixed, and may be adjusted to accommodate future planning needs.

Source: Rancho Cucamonga and San Bernardino County Assessor, 2008.

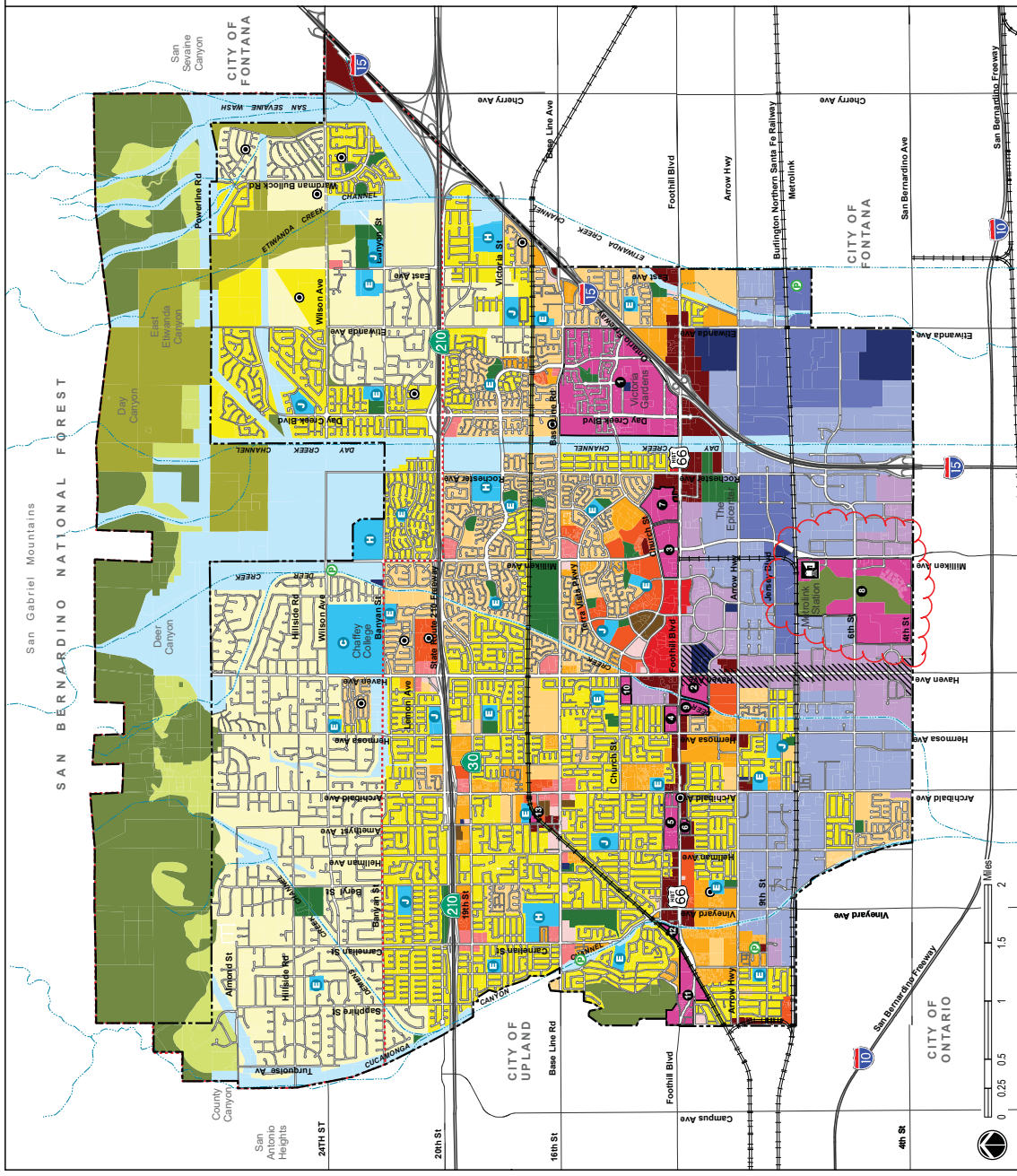

Figure LU-2:
Land Use Plan

Managing Land Use, Community Design, and Historic Resources
RANCHO CUCAMONGA GENERAL PLAN



- Mixed Use Areas**
1. Victoria Gardens
 2. Town Center (Foothill Blvd & Haven Ave)
 3. Terra Vista
 4. Foothill Blvd (Hermosa Ave & Center Ave)
 5. Foothill Blvd (Archibald Ave & Hellman Ave)
 6. Foothill Blvd (Heims Ave and Hampshire St)
 7. Foothill Blvd & Mayten Ave
 8. Industrial Area Specific Plan (Sub-Area 18)
 9. Haven Ave & Church St Site
 10. Western Gateway (Base, Catch Areas)
 11. Eastern Gateway (Base, Catch Areas)
 12. Foothill Station
 13. Historic Alta Loma (Amethyst St Site)

- Base Layers**
- City Boundary
 - Sphere of Influence
 - Waterways
 - Freeway
 - Roads
 - Railroads

Source: Rancho Cucamonga, 2001 and San Bernardino County Assessor, 2009.

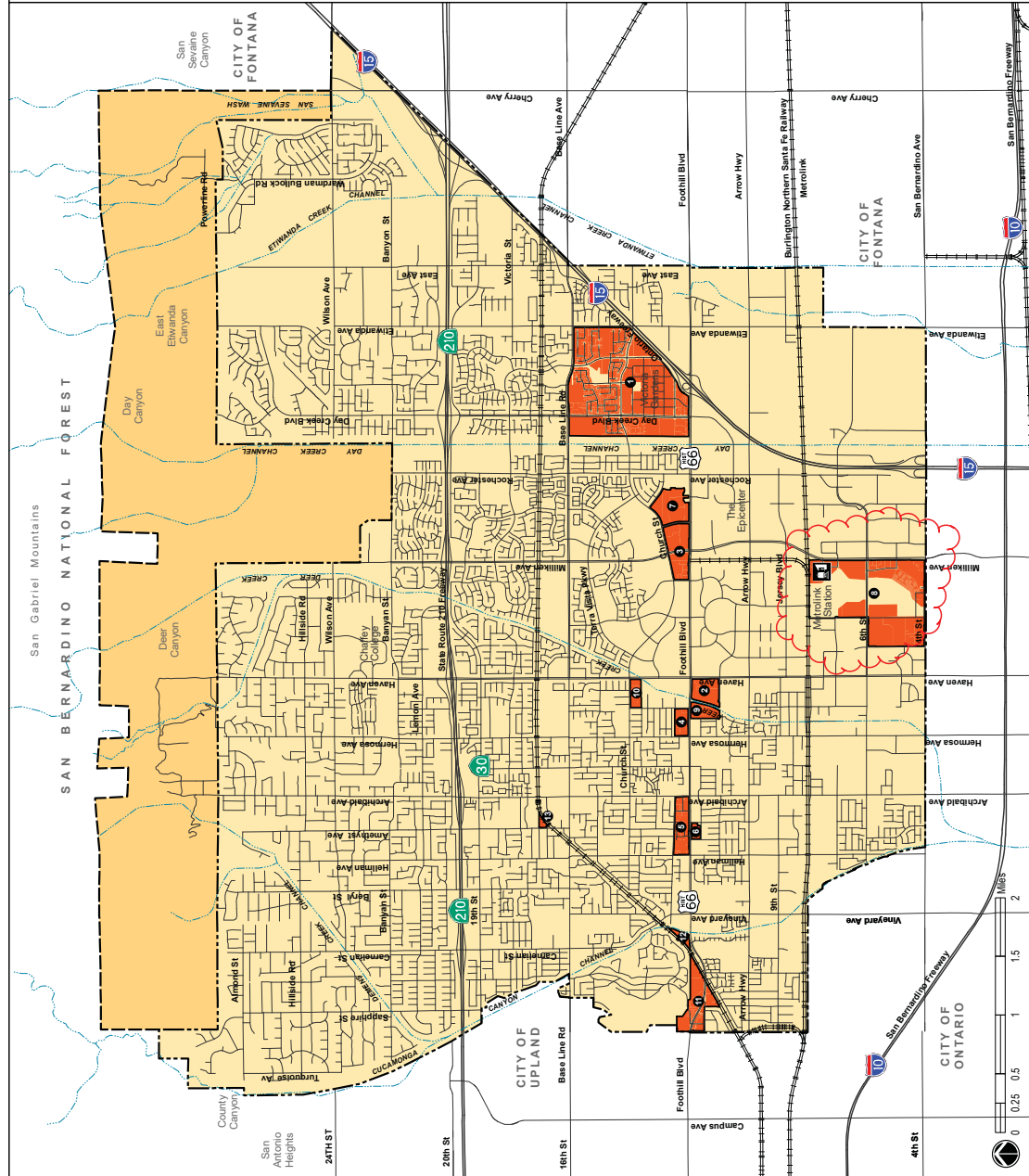

Figure LU-3:
Mixed Use Areas

Managing Land Use, Community Design, and Historic Resources
RANCHO CUCAMONGA GENERAL PLAN

Table LU-8: Mixed Use: Foothill Boulevard and Mayten Avenue

Land Use	Percent Range	Acreage Range Average Density (du/acre) Dwelling Unit Range	Estimated “Most Case” Acres/Dwelling Units (du)
Commercial	40%-60%	19.1-28.7 acres	28.7 acres
Office – professional	6%-10%	2.9-4.8 acres	4.8 acres
Public/Quasi-Public – parks/public plazas	4%	1.9 acres	1.9 acres
Residential	26%-50%	12.4-23.9 acres @ 24 - 30 du/acre [†] 298 to 717 du	12.4 acres @ 30 du/acre [†] 372 du
Totals	100%	47.8 acres	47.8 acres

Note:

1. Indicates target density, not a range. Actual density may increase up to 30 du/ac as long as the total of 717 dwelling units is not exceeded.

The residential component will provide connections in the form of small interior streets and pedestrian paseos to the commercial and office components of the development. Residential development should also include an active street front instead of blank walls along Mayten Avenue and Malaga Drive, and interior streets to connect the various parts of the development. Isolated and gated residential development that is walled off from adjoining uses would be prohibited.

Nearly two acres of public space in the form of public plazas and fountains will provide people with gathering areas in the commercial component of the development. Additional recreational amenities are also encouraged for the residential component of the development.

Mixed Use: Industrial Area Specific Plan (Sub-Area 18)

This area is bounded on the south by 4th Street, on the east by Milliken Avenue, on the north by the railroad, and on the west by Utica Street (#8 on Figure LU-3). ~~The development is entirely built out. It surrounds an 18-hole golf course and~~ includes the Metrolink Station off Milliken Avenue. The Industrial Area Specific Plan (Empire Lakes) Mixed Use area reflects the mixed land use approved under the Rancho Cucamonga IASP Sub-Area 18 Specific Plan. The intent of the Mixed Use designation is to:

- Promote planning flexibility to achieve more creative and imaginative employment-generating designs
- Integrate a wider range of retail commercial, service commercial, recreation, and office uses within this industrial area of the City
- Allow for the sensitive inclusion of high-density residential development that offers high-quality multi-unit condominiums and apartments for employees desiring housing close to work and transit

~~Table LU 9 specifies the uses and range of development allowed.~~

~~Table LU-9: Mixed Use: Industrial Area Specific Plan/Subarea 18~~

Land Use	Percent Range	Acres/Acre Range Average Density (du/acre) Dwelling Units	Estimated "Most Case" Acres/Dwelling Units (du)
Commercial—retail, service commercial, tourist-commercial, office (commercial and professional)	15%-25%	34-57 acres	40 acres
Office—professional, medical corporate offices	40%-60%	90-136 acres	110.5 acres
Public/Quasi-Public/Recreation	7.5%	16.5 ac	16.5 acres
Residential	11%-22%	25-50 acres @ 27.75 du/acre¹ 694 to 1,388 du	50 acres @ 27.75 du/acre¹ 1,388 du
ROW—Metrolink Parking	4.5%	10.3 ac	10.3 acres
Totals	100%	227 acres	227 acres

Note:

~~1. Indicates target density, not a range. Actual density may increase up to 27.75 du/ac as long as the total of 1,388 dwelling units is not exceeded.~~

Mixed Use: Foothill Boulevard and Deer Creek Channel

This site, located at Foothill Boulevard along Deer Creek Channel (#9 on Figure LU-3), provides an excellent opportunity to integrate commercial and residential uses into a cohesive development. Commercial development will be sited along the Foothill Boulevard frontage, while residential development will be located toward the southern area of the property. Development should provide pedestrian access between uses and direct pedestrian connections to Foothill Boulevard and transit stops. High-density development should step down to detached residential development along the western boundary providing a transition to the adjacent low-density residential development. Public street connections to Hampshire Street and Devon Street in the adjacent residential neighborhood will be discouraged, except for emergency vehicles.

Table LU-10 specifies the uses and range of development allowed.

Table LU-10: Mixed Use: Foothill Boulevard and Deer Creek Channel

Land Use	Percent Range	Acres/Acre Range Average Density (du/acre) Dwelling Unit Range	Estimated "Most Case" Acres/Dwelling Units (du)
Commercial	25%-30%	4.4-5.3 acres	5.3 acres
Residential	70%-75%	12.4-13.3 acres @ 10-14 du/acre ¹ 124 to 186 du	12.4 acres @ 14 du/acre ¹ 174 du
Totals	100%	17.7 acres	17.7 acres

Note:

1. Indicates target density, not a range. Actual density may increase up to 14 du/ac as long as the total of 186 dwelling units is not exceeded.

INSERT the following text in place of Table LU-9:

The Rancho Cucamonga Industrial Area Specific Plan (IASP) Subarea 18 Specific Plan is located north of 4th Street, south of a commuter and freight railway, west of Milliken Avenue, and east of Utica/Cleveland Avenues (#8 on Figure LU-3). The plan provides a more urban, medium-to-high density development pattern with a mix of attached and detached residences, non-residential (office, commercial, etc.) uses, and private and common open space areas. Characteristic of the plan will be its pedestrian-oriented setting and access to various transit options including the Metrolink San Bernardino Line via the Rancho Cucamonga Station located at the northeast corner of the specific plan area. The plan is intended to provide a unique and engaging experience that offers to residents convenient access to areas for work, service/commerce, recreational activities, and public spaces. The plan reflects the mixed land use approved under the Rancho Cucamonga IASP Subarea 18 Specific Plan. The intent of the Mixed Use designation is to:

- Promote planning flexibility to achieve more creative and imaginative employment-generating designs;
- Integrate a wider range of retail commercial, service commercial, recreation, and office uses within this industrial area of the City;
- Allow for the sensitive inclusion of high-density residential development that offers high-quality multi-unit condominiums and apartments for employees desiring housing close to work and transit.

Note: Table to be updated by City

Table LU-15: Build-Out Summary

	Baseline: 2009 ¹			General Plan Build Out: 2030			Change (total only)	Percent Change
	City	SOI ²	Total	City	SOI ²	Total		
Dwelling Units	55,608	91	55,699	62,196	1,057	63,253	7,554	13.6%
Population	179,200	300	179,500	200,400	3,400	203,800	24,300	13.5%
Non-Residential Square Feet	80,030,000	0	80,030,000	99,797,000	0	99,797,000	19,767,000	24.7%
Employment	77,350	0	77,350	103,040	0	103,040	25,690	33.2%

Notes:

1. 2009 Baseline data is based on Existing Land Use Geographical Information Systems land use data.
2. SOI: Rancho Cucamonga Sphere of Influence.

Note: Table to be updated by City

Table LU-16: Land Use Plan Summary-Residential Designations

Land Use Designations	Density Factor ¹		City Area		Sphere of Influence			Totals		
	Acres	Dwelling Units ²	Target Dwelling Units ³	Acres	Dwelling Units ²	Target Dwelling Units ³	Total Acreage	Total Dwelling Units	Total Target Dwelling Units	
Residential Designations										
Hillside (0.1-2.0 du/ac)	133	13 to 268	151	695	70-1,400	831	828	83-1,668	982	
Very Low (0.10-2.0 du/ac)	4,007	401 to 8,029	7,394	-	-	-	4,007	401-8,029	7,394	
Low (2.0-4.0 du/ac)	4,371	9,194 to 18,080	18,050	-	-	-	4,371	9,194-18,080	18,050	
Low Medium (4.0-8.0 du/ac)	1,852	7,739 to 15,100	13,320	-	-	-	1,852	7,739-15,100	13,320	
Medium (8.0-14.0 du/ac)	790	6,270 to 10,837	9,283	-	-	-	790	6,270-10,837	9,283	
Medium High (14.0-24.0 du/ac)	367	5,237 to 8,915	7,432	-	-	-	367	5,237-8,915	7,432	
High (24.0-30.0 du/ac)	44	1,376 to 1,713	1,221	-	-	-	44	1,376-1,713	1,221	
Mixed Use ⁴	276	3,701 to 6,511	5,345	-	-	-	276	3,701-6,511	5,345	
Open Space (0.0-0.1 du/ac)	483	0 to 48	- ⁵	2,496	0-250	226	2,979	0-298	226	
RESIDENTIAL SUBTOTAL	12,323	33,931 to 69,501	62,196	3,191	70-1,650	1,057	16,513	34,001-71,151	63,253	

Notes:

1. The Density Factor is based upon actual development that has occurred in the City and represents a level midway between 50% and 75% of the range. It is used to calculate the target number of dwelling units. This factor is only applied to vacant developable lands. A different Density Factor was applied to existing development to obtain an accurate baseline number.
2. The range of dwelling units is derived by multiplying the lower and upper threshold of density/intensity range by the number of acres, and rounded to the nearest whole number. This range represents the theoretical potential. Some development will produce densities at or near the top of the range; however, most will not.
3. Target dwelling units is the probable level of development based on historical development patterns, except for Mixed Use Residential, which is based primarily on a target density.
4. Mixed Use allows both residential and non-residential uses.
5. Open Space is generally a non-residential category that permits a very limited number of residential units on privately owned properties. Within the City, Open Space applies to the golf courses and the Pacific Electric Trail. In the northwest quadrant of the City, a few properties are designated Open Space and could yield residential units. However, any such development would be limited to a density of 0.1 units per acre (or one unit per parcel on lots less than 10 acres in size) and would be subject to the slope, drainage, flood zones, and fault zone analysis at a minimum under the Hillside Overlay Ordinance, further limiting any residential development potential.

Table LU-17: Land Use Plan Summary-Non-Residential Designations

Land Use Designations	Acres		Square Feet (in thousands) ¹ (City Only)	Probable Square Feet (in thousands) (City Only)	Employment ³ (City Only)	Total Acres
	City	SOI				
Non-Residential²						
Office (0.40-1.0 FAR)	86	-	1,497 to 3,746	1,497	3,180	86
Neighborhood Commercial (0.25-0.35 FAR)	164	-	1,785 to 2,500	1,785	3,030	164
Community Commercial (0.25-0.35 FAR)	119	-	1,292 to 1,810	1,292	1,970	119
General Commercial (0.25-0.35 FAR)	470	-	6,555 to 7,165	6,555	10,020	470
Subtotal	839	-	11,129 to 15,221	11,129	18,200	839
Mixed Use (0.25-1.0 FAR) ⁴	626	-	6,498 to 25,996	11,973	20,270	626
Subtotal	626	-	6,498 to 25,996	11,973	20,270	626
Industrial Park (0.40-0.60 FAR)	559	-	9,739 to 14,610	9,739	6,610	559
- Haven Overlay (0.40-1.0 FAR)	215	-	3,745 to 9,365	3,745	7,950	215
General Industrial (0.50-0.60 FAR)	1,974	-	42,993 to 51,592	42,993	29,220	1,974
Heavy Industrial (0.40-0.50 FAR)	891	-	15,523 to 19,405	15,523	15,820	891
Subtotal	3,639	-	72,000 to 94,972	72,000	59,600	3,639
Open Space (0.0-0.10 du/ac)	483	2,496	-	-	-	2,979
Conservation	353	983	-	-	-	1,336
Flood Control/Utility Corridor	1,711	1,753	-	-	-	3,464
Subtotal	2,547	5,232	-	-	-	7,779
Civic/Regional (0.40-1.0 FAR)	130	-	2,265 to 5,662	2,265	1,050	130
Schools (0.10-0.20 FAR)	558	-	2,430 to 4,861	2,430	3,920	558
Parks	445	-	-	-	-	445
Subtotal	1,133	-	4,695 to 10,523	4,695	4,970	1,133
NON-RESIDENTIAL SUBTOTAL	8,784	5,232	94,322 to 146,712	99,797	103,040	14,016

Notes:

1. The range of square footage is derived by multiplying the probable lower and upper threshold of intensity range by the number of acres, and rounded to the nearest hundred.
2. Non-residential FAR Range: lower number is the probable FAR on average, but in some cases it may be lower. Higher number is the maximum FAR allowed for any specific project.
3. Employment is calculated by using the Probable Square Feet and employment factors for each non-residential land use designations.
4. Mixed Use allows both residential and non-residential use.

Table LU-18: Build Out Summary by Land Use

Land Use Designations	Acres ¹			Percent of Total	Target Dwelling Units			Probable Non-Residential (City Only)	
	City	SOI	Total		City	SOI	Total	Square Feet (in thousands)	Employment
Hillside Residential (0.1-2.0 du/ac)	133	695	828	3.1%	151	831	982	-	-
Very Low Residential (0.1-2.0 du/ac)	4,007	-	4,007	15.1%	7,394	-	7,394	-	-
Low Residential (2.0-4.0 du/ac)	4,371	-	4,371	16.5%	18,050	-	18,050	-	-
Low Medium Residential (4.0-8.0 du/ac)	1,852	-	1,852	7.0%	13,320	-	13,320	-	-
Medium Residential (8.0-14.0 du/ac)	790	-	790	3.0%	9,283	-	9,283	-	-
Medium High Residential (14.0-24.0 du/ac)	367	-	367	1.4%	7,432	-	7,432	-	-
High Residential (24.0-30.0 du/ac)	44	-	44	0.2%	1,221	-	1,221	-	-
Mixed Use ²	902	-	902	3.4%	5,345	-	5,345	11,973	20,270
Office (0.40-1.0 FAR)	86	-	86	0.3%	-	-	-	1,497	3,180
Neighborhood Commercial (0.25-0.35 FAR)	164	-	164	0.6%	-	-	-	1,785	3,030
Community Commercial (0.25-0.35 FAR)	119	-	119	0.4%	-	-	-	1,292	1,970
General Commercial (0.25-0.35 FAR)	470	-	470	1.8%	-	-	-	6,555	10,020
Industrial Park (0.40-0.60 FAR)	559	-	559	2.1%	-	-	-	9,739	6,610
- Haven Ave Office Overlay (0.40-1.0 FAR)	215	-	215	0.8%	-	-	-	3,745	7,950
General Industrial (0.50-0.60 FAR)	1,974	-	1,974	7.4%	-	-	-	42,993	29,220
Heavy Industrial (0.40-0.50 FAR)	894	-	894	3.4%	-	-	-	15,523	15,820
Open Space (0.0-0.1 du/ac)	483	2,496	2,979	11.2%	-	226	226	-	-
Conservation	353	983	1,336	5.0%	-	-	-	-	-
Flood Control/Utility Corridor	1,711	1,753	3,464	13.0%	-	-	-	-	-
Civic/Regional (0.40-1.0 FAR)	130	-	130	0.5%	-	-	-	2,265	1,050
Schools (0.10-0.20 FAR)	558	-	558	2.1%	-	-	-	2,430	3,920
Parks	446	-	445	1.7%	-	-	-	-	-
GRAND TOTAL	20,624	5,927	26,551	100.0%	62,196	1,057	63,253	99,797	103,040

Notes:

1. Acres include existing development and undeveloped vacant properties.
2. Mixed Use allows both residential and non-residential uses.

Note: Table to be updated by City

An additional purpose is to capture and reflect the historic significance of this route as part of the legendary Route 66 that linked Los Angeles and Chicago for several critical decades during the twentieth century. Such landmarks as the Sycamore Inn and the Magic Lamp Restaurant symbolize that memorable period in the emergence of Southern California as a mecca for families seeking a better life. The combination of use patterns, development standards, and design guidelines of the plan testify to the area's complex planning issues and the need for creative regulatory devices. Ultimately, the goal of the Specific Plan is to give this critical centerpiece of the City the prominence it deserves.

Industrial Area Specific Plan

The Industrial Area Specific Plan is a particularly significant specific plan due to its successful role in the development of the City's industrial base (which is a critical component of an overall long-term balance of uses). Part of this success can be attributed to the quality standards incorporated into the Specific Plan and the protection those standards afford to business investors in this area. The Specific Plan, encompassing nearly 5,000 acres, has been divided into three zones and 19 subareas. The subareas represent specific land use characteristics and development constraints which can be dealt with on a subarea basis rather than through the application of broadly applied development standards. The purpose of the Specific Plan is to establish specific standards and guidelines that will be used for development throughout the City's industrial area.

Industrial Area Specific Plan Sub-Area 18 Plan (Empire Lakes)

The purpose of the Sub-Area 18 Specific Plan is to provide for a broader mix of land uses than was originally permitted within the Industrial Area Specific Plan. The plan was expanded to include such uses as recreational, hotel/conference center, retail, restaurant, and entertainment, as well as office, research and development, and light industrial uses. ~~These uses are intended to surround the existing 18-hole golf course.~~ A subsequent amendment to further expand the use list included ~~limited~~ multi-unit residential development to maximize potential use of the Metrolink Station near Milliken Avenue.

Adopted Planned Communities

Caryn Planned Community Development Plan

The Caryn Planned Community Development Plan, now completed, lies north of the Victoria planned community. The community's special identity is provided by an elementary school, single-unit residential development, and walking trails that tie the community together.

Terra Vista Community Plan

The Terra Vista Community Plan area is centrally located in Rancho Cucamonga and encompasses 1,321 acres. It is comprised of four distinct neighborhoods, with a greenway serving as the backbone connector. The area is planned for a mix of residential and commercial uses, with a large concentration of commercial and office uses along Foothill Boulevard and Haven Avenue that serves as a community-wide activity center.

Victoria Community Plan

The Victoria Community Plan area encompasses 2,150 acres and provides for a series of residential villages and related support uses, designed around a central spine called Victoria Park Lane. Victoria Community Plan includes the Victoria Arbors Master Plan and the Victoria Gardens Master Plan.

Open Space Resources

Open space is defined as any parcel or area of land that is essentially unimproved and devoted to uses such as natural resource preservation, managed production of resources, outdoor recreation, and public health and safety. Open spaces can be found throughout the City. Natural open spaces are primarily located in the hillsides and Sphere of Influence areas of the City, while urban open spaces, such as developed parks and open plazas can be found in the built areas of the City.

Preservation of open space benefits environmental sustainability and promotes the Healthy RC Initiative. Open space allows the recharge of groundwater basins, which provide a clean source of water for everyday use to the Rancho Cucamonga community. Open space provides plentiful opportunities for recreational activities such as hiking and bird watching as well as areas of scientific and educational value. Preservation of open space serves to protect views and retain a connection to our environmental and cultural history. Open space also provides protection from natural hazards such as flooding and wildland fires. And finally, open space is not just limited to the hillsides; within the urban area, open space provides softening and contrast to the built environment, active and passive recreational opportunities, view corridors, and general enhancement of the overall visual quality of the City.

Established Open Space Areas

Approximately 31 percent, or 8,224 acres, of the Planning Area is devoted to open space, including parks, undeveloped parcels, conservation areas, and flood control/utility corridors, as shown in Figure RC-1: Open Space and Conservation Plan. Hillside Residential and Very Low-density Residential areas (two dwelling units or less per acre) also contribute to the rural character within the northern portion of the City and Sphere of Influence area (see Chapter 2, Figure LU-1: Land Use Plan).

Open space in Rancho Cucamonga provides the following benefits:

- **Open Space: Preservation of Natural Resources.** In an effort to protect wildlife and biological resources within Rancho Cucamonga, conservation areas have been established in Rancho Cucamonga's Planning Area. These conservation areas are intended to protect the alluvial fan sage scrub habitat and the wildlife it supports by preserving open space land in its natural state. See the Wildlife Resources section (page RC-26) in this Chapter for more information regarding conservation areas and protection of wildlife resources.
- **Open Space: Managed Protection of Natural Resources.** Open space areas and expansive spreading grounds allow the recharge of groundwater basins, which are a critical resource for the Cucamonga Valley Water District. These areas need to be protected because the Cucamonga Valley Water District obtains a large portion of its water supply from the groundwater basins. Rancho Cucamonga's Sphere of Influence also has limited aggregate resources (sand and gravel), which are found in alluvial fans at the opening of canyons. These are important resources to the construction industry from which Rancho Cucamonga and the region have greatly benefited. However, this resource must be properly managed so that we can protect important habitat areas, allow for appropriate redevelopment, and avoid future land use conflicts. See the Mineral Resources section (page RC-8) in this Chapter for more information.

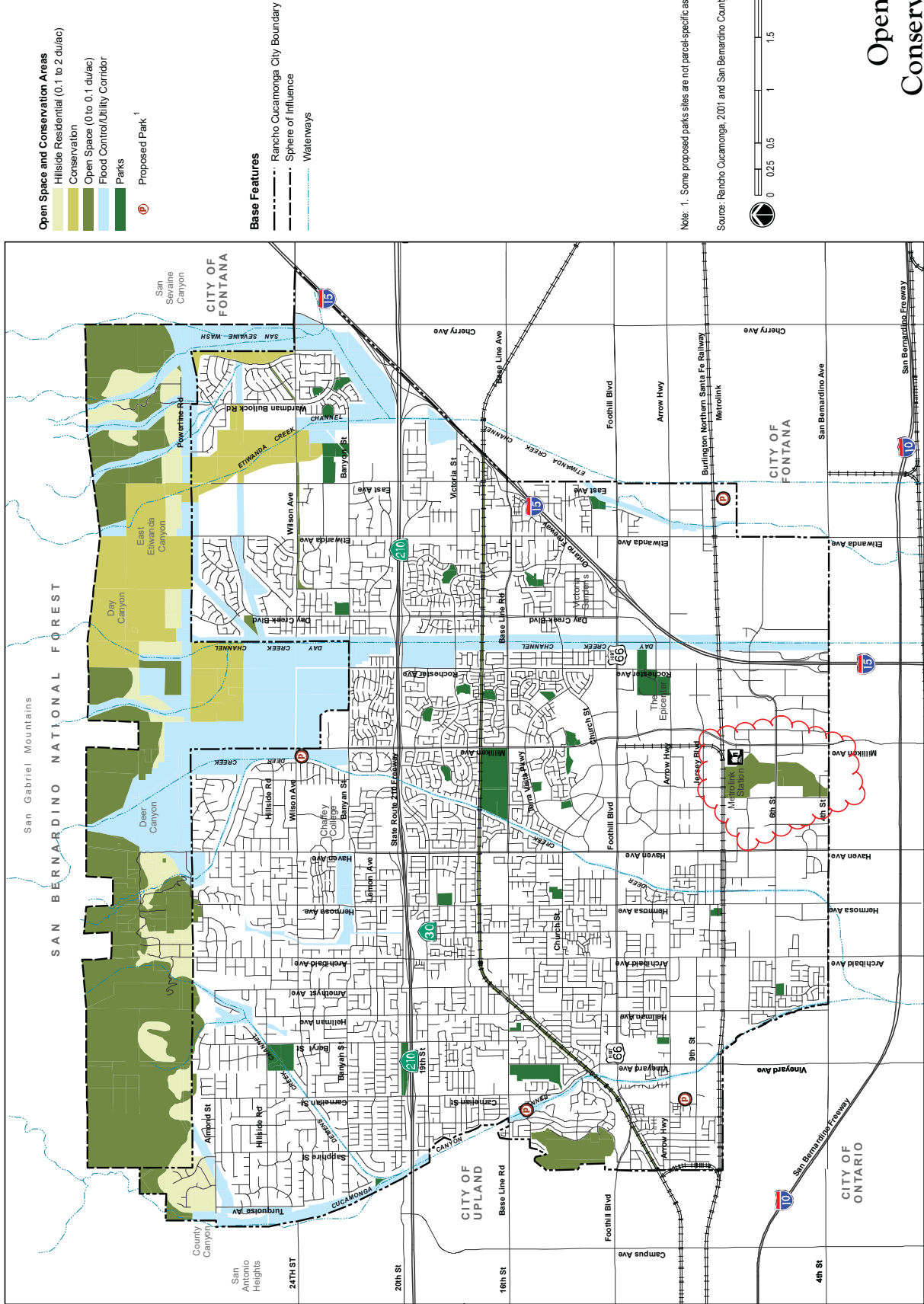

Figure RC-1:
Open Space and
Conservation Plan



Appendix D General Plan Consistency

1.0 General Plan Consistency

Specific Plans must be compatible with the goals and policies of the adopted General Plan. The Rancho Cucamonga General Plan contains numerous policies to guide development and uses planned within the City. This Section contains an analysis of how the project is consistent with the applicable General Plan policies.

Applicable General Plan Policy/Objective		SPA Consistency Discussion
Land Use and Development Policies		
Goal LU-1: Ensure established residential neighborhoods are preserved and protected, and local and community-serving commercial and community facilities meet the needs of residents		
LU-1.1	Protect neighborhoods from the encroachment of incompatible activities or land uses that may have a negative impact on the residential living environment.	<u>Consistent.</u> The SPA will support higher density living environments near transportation alternatives to protect existing neighborhoods from increased density pressures.
LU-1.2	Designate appropriate land uses to serve local needs, and be able to respond to regional market needs.	<u>Consistent.</u> The goal of the SPA is to support smart growth in the city by locating urban housing in proximity to transit, employment and entertainment.
LU-1.3	Encourage commercial centers that serve a broad range of retail and service needs for the community.	<u>Consistent.</u> Commercial centers are an allowed use in the Transit Placetype, Mixed Use Placetype, and Mixed Use Overlay. The urban housing also supports commercial centers within Rancho Cucamonga.
LU-1.5	Development of densities and intensities shall be implemented within the ranges specified in the General Plan within the limits of the range.	<u>Consistent, as amended.</u> General Plan and Zoning Ordinance amendments allow residential densities up to 80 du/ac.
LU-1.6	Encourage small-lot, single-unit attached and/or detached residential development (5,200-square-foot lots or smaller) to locate in areas where this density would be compatible with adjacent residential neighborhoods.	<u>Consistent.</u> The Village Neighborhood and Core Living Placetypes allow small-lot detached or attached neighborhoods in proximity to existing attached neighborhoods.
Goal LU-2: Facilitate sustainable and attractive infill development that complements surrounding neighborhoods and is accessible to pedestrians, bicycles, transit, and automobiles		
LU-2.1	Plan for vibrant, pedestrian-friendly Mixed Use and high-density residential areas at strategic infill locations along transit routes.	<u>Consistent.</u> The SPA allows mixed use and high density residential uses in a pedestrian-friendly setting and great access to transit. The SPA allows up to 3,450 residences, 220,000 square feet of non-residential, and 6.8 acres of recreation amenities within 0.5 mile of the Metrolink station.
LU-2.2	Require new infill development to be designed for pedestrians and automobiles equally, and to provide connections to transit and bicycle facilities.	<u>Consistent.</u> The Vine is designed as a complete street; pedestrian circulation facilitated by the Vine and internal connections; all infill development is within one mile of Metrolink station.
LU-2.3	Provide direct pedestrian connections between development projects where possible.	<u>Consistent.</u> Pedestrian connections to adjacent development open space features are planned where possible.
LU-2.4	Promote complementary infill development, rehabilitation, and re-use that contribute positively to the surrounding residential neighborhood areas.	<u>Consistent.</u> Transit-proximate infill residential and mixed use development will be complementary to adjacent residential and non-residential development.
LU-2.5	Facilitate effective use of land constrained by challenging parcel sizes and dimensions, and encourage consolidation of parcels to provide greater development flexibility.	<u>Consistent.</u> The SPA provides a cohesive development plan for 160-acre infill site.
Goal LU-3: Encourage sustainable development patterns that link transportation improvements and planned growth, create a healthy balance of jobs and housing, and protect the natural environment.		
LU-3.1	Encourage the creation and maintenance of regional employment, cultural, and retail destinations, as well as a full range of amenities and services to support residents of Rancho Cucamonga.	<u>Consistent.</u> Refer to Policies LU-1.2 and LU-1.3.
LU-3.2	Encourage a mix of retail, service, industrial and manufacturing, and professional uses that create diverse, well-paying employment opportunities.	<u>Consistent.</u> Employment, professional, light industrial, and commercial uses are permitted in the Transit Placetype, Mixed Use Placetype, and Mixed Use Overlay.

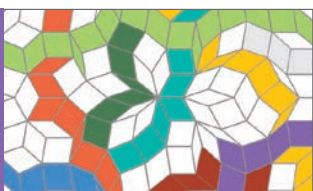

Applicable General Plan Policy/Objective		SPA Consistency Discussion
LU-3.3	Locate regionally serving land uses with immediate access to the regional transportation network that is designed to provide maximum access capabilities and permit maximum dispersal of traffic.	<u>Consistent.</u> Refer to Policy LU-2.1
LU-3.4	Promote development that is sustainable in its use of land and that limits impacts to natural resources, energy, and air and water quality.	<u>Consistent.</u> Previously disturbed infill site will not impact natural resources; public spaces will utilize reclaimed water.
LU-3.5	Work toward a sustainable jobs-housing balance by accommodating a range and balance of land uses within Rancho Cucamonga.	<u>Consistent.</u> Refer to Policy LU-2.1
LU-3.6	Create focused, pedestrian-friendly neighborhoods that are reminiscent of the qualities found in earlier days, particularly within the original communities of Cucamonga, Alta Loma, and Etiwanda, and along Historic Route 66 (Foothill Boulevard).	<u>Consistent.</u> Refer to Policy LU-2.2.
LU-3.7	Encourage new development projects to build on infill vacant sites within a built-out area, and/or redevelop previously developed properties that are underutilized.	<u>Consistent.</u> The SPA allows redevelopment of an existing golf course with mixed use development surrounded by a built-out area.
LU-3.8	Implement land use patterns and policies that incorporate smart growth practices, including placement of higher densities near transit centers and along transit corridors, allowing Mixed Use development, and encouraging and accommodating pedestrian movement.	<u>Consistent.</u> Refer to Policies LU-2.1 and LU-2.2.
LU-3.11	New development should be permitted especially where it is logical to extend existing infrastructure improvements and includes housing of varied densities.	<u>Consistent.</u> The infill site has current access to existing infrastructure; Implementation of the project would result in a varied density of medium to higher density housing with minimum density thresholds.

Community Design Policies

Goal LU-9: Foster a cohesive, healthy community through appropriate patterns and scales of development, including complementary transitions between districts, neighborhoods, and land uses.

LU-9.5	Establish Mixed Use areas as higher intensity “urban centers” where there is sensitive integration of land uses, convenient modes of transportation, and a focused “sense of place” that emanates from the architectural and landscape design.	<u>Consistent.</u> Refer to Policy LU-2.1
--------	--	---

Goal LU-10: Encourage sustainable landscaping and streetscape design.

LU-10.1	Continue to require implementation of the City’s Water Efficiency Ordinance, which should be reviewed and updated periodically.	<u>Consistent.</u> Compliance with the City’s Water Efficiency Ordinance is required.
LU-10.2	Encourage the planting of edible landscaping plants such as citrus trees, box gardens, vineyards, and other plant materials wherever possible.	<u>Consistent.</u> The SPA allows urban farming provisions and a landscape palette that includes edible plants.
LU-10.3	Promote low water usage, and emphasize fire safe defensible space.	<u>Consistent.</u> The landscape plan limits turf and high-water demand plants. Appropriate building separations are provided consistent with the building code.
LU-10.4	Encourage streetscape design and landscaping programs for commercial frontages that create vibrant places which support walking, bicycling, transit, and sustainable economic development.	<u>Consistent.</u> Development standards and design guidelines promote strong pedestrian-oriented streetscape with minimal building setbacks. The Mixed Use Overlay permits non-residential development.

Goal LU-11: Ensure that community aesthetics are maintained through appropriate regulations.

LU-11.2	Continue to require the undergrounding of utility lines and facilities wherever feasible to minimize the unsightly appearance of overhead utility lines and utility enclosures.	<u>Consistent.</u> All utility and facilities will be underground wherever feasible and allowed by utility providers.
---------	---	---

Applicable General Plan Policy/Objective	SPA Consistency Discussion
--	----------------------------

Goal LU-12: Foster a variety of travel routes that are enjoyable ways to experience Rancho Cucamonga.

LU-12.1	Ensure that streetscape design along roadways creates a strong landscaped edge, provides a coherent high-quality appearance along each route, and enhances the image of adjacent development.	<u>Consistent.</u> Streetscape design along 6th Street and 4th Street will provide a coherent appearance and be compatible with adjacent development. The Vine includes landscape and hardscape elements.
LU-12.2	Require the design of transit stops to be compatible with adjacent development and provide for adequate seating, signage, shade, and refuse receptacles.	<u>Consistent.</u> The SPA provides guidelines for bus shelters that would be coordinated with Omnitrans.
LU-12.3	Support development projects that are designed to facilitate convenient access for pedestrians, bicycles, transit, and automobiles.	<u>Consistent.</u> Refer to Policy LU-2.2.

Goal LU-13: Take full advantage of view lines and vista points with carefully designed development.

LU-13.1	On north-south roadways, open space corridors, and other locations where there are views of scenic resources, trees, and structures, encourage framing and orientation of such views at key locations, and endeavor to keep obstruction of views to a minimum.	<u>Consistent.</u> The SPA identifies view corridors. Where possible, the design of the Vine is generally in a north-south orientation.
---------	--	---

Goal LU-14: Support public art as an important amenity of a beautiful City

LU-14.2	Continue to promote the establishment of entry monumentation as a means of identifying communities, districts, and neighborhoods.	<u>Consistent.</u> The SPA includes monumentation and signage standards and guidelines to promote the urban character of the infill site.
---------	---	---

Community Mobility

Goal CM-1: Provide an integrated and balanced multi-modal transportation network of Complete Streets to meet the needs of all users and transportation modes.

CM-1.1	Continue to provide a safe and efficient street system in the City, to support mobility goals, all transportation modes, and the goals of Managing the Land Use, Community Design, and Historic Resources Chapter.	<u>Consistent.</u> The SPA supports mobility goals under the City's General Plan.
CM-1.2	Provide an integrated network of roadways that provides for convenient automobile, transit, bicycle, and pedestrian circulation movement around the City.	<u>Consistent.</u> The SPA provides adequate internal circulation with a high level of access to and from the Metrolink station, 6th Street, and 4th Street via the Vine.
CM-1.5	Implement street design standards per this General Plan, except that modified standards may be applied where appropriate on arterial corridors relating to transit, bicycle facilities, sidewalks, and on-street parking to be context sensitive to adjacent land uses and districts, and to all roadway users, including transit, bicycles, and pedestrians.	<u>Consistent.</u> The SPA includes modified street standards for the envisioned community with enhanced pedestrian facilities appropriate for the context, densities and land uses proposed..

Goal CM-2: Plan, implement, and operate transportation facilities to support healthy and sustainable community objectives.

CM-2.1	Facilitate bicycling and walking citywide.	<u>Consistent.</u> The SPA includes a continuous pedestrian and bikeway corridor along the Vine that links users from the Metrolink station to 4th Street. Pedestrians may also use the existing 6th Street undercrossing to avoid the 6th Street intersection. The Vine is designed to include a protected bike lane for enhanced bicycle connectivity traveling north/south through the site.
CM-2.2	Encourage all feasible measures to reduce total vehicle miles traveled by automobiles, including enhanced transit access and land use approaches that provide compact and focused development along major transit corridors.	<u>Consistent.</u> Refer to Policy LU-2.1.
CM-2.3	Support the use of hybrid, electric, and low/zero emission vehicles.	<u>Consistent.</u> All development shall comply with the electric vehicle charging requirements of the CALGreen Code.
CM-2.5	Establish priority parking locations for hybrid, electric, and low/zero emission, and alternative fuel vehicles.	<u>Consistent.</u> Non-residential development shall comply with the designated parking requirements of the CALGreen Code.
CM-2.6	Accommodate charging and fueling stations for alternative fuel vehicles, and put forth strong efforts to have charging facilities provided at employment centers.	<u>Consistent.</u> Refer to Policy CM-2.3.



Applicable General Plan Policy/Objective		SPA Consistency Discussion
CM-2.7	Require new developments of more than 100 employees (per building or per tenant/company) to develop Transportation Demand Management programs to minimize automobile trips and to encourage use of transit, ridesharing, bicycling, and walking.	<u>Consistent.</u> While it is not expected that there would be large employers, Mitigation Measure 2-6 requires tenants/operators of non-residential uses to post both bus and Metrolink schedules in conspicuous areas and to configure the employee work schedules around the Metrolink schedule to the extent reasonably feasible.
CM-2.8	Support the installation of high-speed communications infrastructure to facilitate the ability of residents to work at home.	<u>Consistent.</u> All homes and businesses shall accommodate modern telecommunications technology.
Goal CM-3: Provide a transportation system that includes connected transit, bicycle, and pedestrian networks		
CM-3.7	Continue to develop and maintain a citywide bicycle network of off-street bike paths, on-street bike lanes, and bike streets to provide connections between neighborhoods, schools, parks, civic center/facilities, recreational facilities, and major commercial centers.	<u>Consistent.</u> Refer to Policy CM-2.1.
CM-3.8	Continue to encourage the provision of bicycle facilities, such as bicycle lockers and secure bike parking, throughout the City.	<u>Consistent.</u> The SPA includes requirements for bicycle parking per CALGreen.
CM-3.10	Continue to complete the installation of sidewalks and require new development to provide sidewalks.	<u>Consistent.</u> All public streets and collector roads will provide sidewalks.
CM-3.11	Continue to provide pedestrian amenities on sidewalks on major streets that are key pedestrian routes, including the provision of benches, shade trees, and trash cans.	<u>Consistent.</u> The SPA includes standards and guidelines for pedestrian and bicycle amenities along the Vine, other roads and 3rd Place spaces.
CM-3.12	Continue to require that the siting and architectural design of new development promote safety, pedestrian-friendly design, and access to transit facilities.	<u>Consistent.</u> Refer to Policies LU-2.2 and LU-10.4.
CM-3.13	Establish a number of bike hubs in the City (centralized locations with convenient bike parking for trip destinations or transfer to other transportation modes), at key transit nodes, and at commercial nodes.	<u>Consistent.</u> Refer to Policies CM-3.8 and CM-3.11.
CM-3.14	Enhance pedestrian and bicycle access to local and regional transit, including facilitating connections to transit.	<u>Consistent.</u> Refer to Policy CM-2.1.
Goal CM-5: Require that new development mitigate transportation impacts and contribute to the improvement of the City's transportation system.		
CM-5.1	Continue to require that new development participates in the cost of transportation mitigation and improvements necessitated by new development, including non-automobile solutions.	<u>Consistent.</u> Development will be required to participate in the cost of transportation mitigation and improvements.
CM-5.2	Require evaluation of potential traffic and transportation impacts associated with new development prior to project approval, and require adequate mitigation measures, including non-automobile solutions prior to, or concurrent with, project development.	<u>Consistent.</u> A Traffic Impact Analysis has been prepared. In addition to multi-modal circulation facilities, mitigation measures are identified to reduce impacts.
CM-5.3	Require that new and substantially renovated office, retail, industrial, and multi-family developments implement transit amenities, including bus turnouts, transit shelters, and other streetscape elements, as appropriate.	<u>Consistent.</u> The project site is located near the Metrolink station and Omnitrans bus routes. The Transit Placetype facilitates easy pedestrian and bicycle access through the site and supports transit and multi-modal users with commercial, retail, and services. At the time of development, plans will be reviewed by the City and/or transit agency for appropriate bus stops/shelter locations. Transit services may include, but not be limited to car-share facilities, bike-share stations, transit pass kiosks, or concierge services. All projects would meet CALGreen requirements related to bicycle parking.

Applicable General Plan Policy/Objective		SPA Consistency Discussion
CM-5.4	Require that new and substantially renovated office, retail, industrial, institutional and multi-family developments to provide bicycle and pedestrian amenities on site and/or in the vicinity of the development to facilitate bicycling and walking, including on-site bike paths where appropriate, secure off-street bicycle parking, sidewalk improvements, benches, and should encourage such developments to provide bicycle facilities such as, showers and changing rooms.	<u>Consistent.</u> Refer to Policies CM-2.1 and CM-3.8.
CM-5.5	Allow shared parking between land uses where feasible and appropriate, and encourage “park-once” strategies to facilitate the efficient use of parking resources.	<u>Consistent.</u> The SPA includes strategies and a process for reducing demand for parking and provides for shared parking facilities.

Economic Development Policies

Goal ED-1: Achieve and maintain a diverse and sustainable economic base

ED-1.4	Create opportunities for residents and workers to have local access to the full range of retail needs in appropriate areas throughout the City.	<u>Consistent.</u> The transit-oriented infill development allows residents to be near existing commercial areas and opportunities for development of on-site retail and services.
ED-1.5	Support housing opportunities for workers of all income ranges.	<u>Consistent.</u> The SPA provides new housing options for workforce families, young professionals and allow entry level and move-up home ownership opportunities in an urban setting based on a range of permitted densities.

Goal ED-2: Maintain local long-term fiscal sustainability

ED-2.2	Diversify the City’s retail base.	<u>Consistent.</u> The Mixed Use and Transit Placetype designations and the Mixed Use Overlay allow mixed use and non-residential development in configurations not typical of other developments in the City and in close proximity to transit.
--------	-----------------------------------	--

Goal ED-3: Continue to emphasize quality as a core community value as it applies to local workers and residents.

ED-3.2	Provide community and cultural amenities.	<u>Consistent.</u> The SPA includes outdoor gathering spaces, 3rd place nodes, recreational areas, and other site amenities that would create a cohesive community and can be used for cultural amenities or to promote cultural events.
ED-3.4	Improve internal circulation for all modes of transportation, consistent with the concept of “Complete Streets”.	<u>Consistent.</u> Refer to Policy LU-2.2.

Goal ED-4: Implement consistent high-quality standards for all future development.

ED-4.1	Encourage high-quality design for infill development and continue to support new high quality uses.	<u>Consistent.</u> The SPA includes development standards and design guidelines to enable high-quality urban infill development with mixed use opportunities.
ED-4.2	Make green building and green business a priority.	<u>Consistent.</u> The SPA implements green building principles relating to mixed use and transit-oriented development near the Metrolink station. All development would be constructed in compliance with 2013 CALGreen requirements. Additionally, mitigation measures require compliance with certain voluntary provisions of the CALGreen code.
ED-4.3	Improve connectivity between development projects to create a more cohesive atmosphere.	<u>Consistent.</u> Vehicular and pedestrian connections are provided between projects and to the Metrolink station. Refer to Policy LU-2.3.

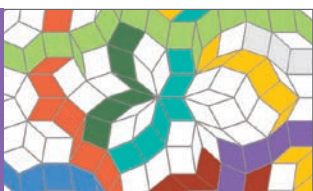

Applicable General Plan Policy/Objective	SPA Consistency Discussion
--	----------------------------

Community Services Policies

Goal CS-1: Provide attractive, high-quality community services facilities that adequately meet the community's need.

CS-1.1	Provide adequate park and recreational facilities that meet the City standard of 5.0 acres of parkland (including trails and special facilities) for every 1,000 persons.	Consistent. Parkland/recreation facilities include the provision of on-site facilities and open space (the facilities qualifying for a credit towards the minimum requirement would be determined by the Community Services Department); provision of a joint use facility to be used by the Community Services Department, Library Department and Police Department or alternative community benefit agreed to be the City and the Property Owner/Developer; and payment of applicable mitigation fees.
CS-1.2	Develop parks that contribute to active and healthy lifestyles, and allow for a balanced commitment to both organized recreation activities and passive park environments.	Consistent. The SPA requires the development of "3rd Place spaces" throughout the project to provide smaller passive and programmed open spaces; private recreation amenities will be provided in the REC Placetype.
CS-1.5	Continue to require new development to provide needed park facilities through the various measures and tools available to the City (e.g., in-lieu fees and/or land dedication).	Consistent. Refer to Policy CS-1.1.
CS-1.7	Encourage public safety and compatibility with adjacent uses through park location and design, including the location of buildings, lighting, parking, public transit, emergency access, and pedestrian/bicycle access.	Consistent. The SPA standards and guidelines consider public safety, compatibility and location of buildings and pathways adjacent to existing development.

Goal CS-7: Encourage healthy lifestyles for all Rancho Cucamonga residents.

CS-7.1	Consider all opportunities to encourage community gardens and similar community gathering places.	Consistent. Refer to Policies LU-10.2 and CS-1.2.
--------	---	---

Resource Conservation Policies

Goal RC-1: Encourage stewardship of natural open space areas, environmentally sensitive lands, and agricultural resources.

RC-1.2	Develop measures to preserve and enhance important views along north-south roadways, open space corridors, and at other key locations where there are significant views of scenic resources.	Consistent. Refer to Policy LU-13.1.
--------	--	--------------------------------------

Goal RC-3: Support the use of water that is both efficiently consumed and recycled to minimize waste and maximize supplies.

RC-3.1	Require the use of cost-effective methods to conserve water in new developments, and promote appropriate water conservation and efficiency measures for existing businesses and residences.	Consistent. Refer to Policy LU-10.1.
RC-3.3	Support efforts to expand the recycled water distribution system and actively promote the widespread use of recycled water in Rancho Cucamonga.	Consistent. The existing site utilizes reclaimed water resources; implementation of the project will use reclaimed water for open space watering.

Goal RC-4: Encourage the use of energy resources that are efficiently expended and obtained from diverse and sustainable sources, in an effort to minimize greenhouse gas and other air emissions

RC-4.1	Pursue efforts to reduce energy consumption through appropriate energy conservation and efficiency measures throughout all segments of the community.	Consistent. The SPA development will meet the adopted California Energy Standards and CALGreen requirements.
RC-4.2	Promote the use of renewable energy and alternative energy technology, and support efforts to develop small-scale, distributed energy generation (e.g. solar, wind, cogeneration, and biomass) to reduce the amount of electricity drawn from the regional power grid and reduce the use of natural gas, while providing Rancho Cucamonga with a greater degree of energy and economic self-sufficiency.	Consistent. Refer to Policy RC-4.1.

Applicable General Plan Policy/Objective		SPA Consistency Discussion
RC-4.3	Encourage the use of solar energy systems in homes and commercial businesses.	<u>Consistent.</u> Refer to Policy RC-4.1.
RC-4.4	Reduce operational energy requirements through sustainable and complementary land use and circulation planning. Support implementation of State mandates regarding energy consumption and greenhouse gas reduction, including AB32 and SB375.	<u>Consistent.</u> Refer to Policy LU-2.1.

Goal RC-6: Encourage and support green buildings in Rancho Cucamonga.

RC-6.2	Encourage green practices for new and existing buildings throughout the community.	<u>Consistent.</u> Refer to Policy RC-4.1.
RC-6.3	Promote energy-efficient design features, including but not limited to, appropriate site orientation, use of light-colored roofing and building materials, and use of deciduous trees and wind-break trees to reduce fuel consumption for heating and cooling beyond the minimum requirements of Title 24 State Energy Codes.	<u>Consistent.</u> Refer to Policy RC-4.1.
RC-6.4	Promote green practices and the use of energy saving designs and devices for new and existing buildings throughout the community. Consult with energy providers such as Southern California Edison, Southern California Gas, the Rancho Cucamonga Municipal Utility, and others to establish and coordinate energy efficiency programs that promote energy efficient design in all projects and assist residential, commercial, and industrial users.	<u>Consistent.</u> Refer to Policy RC-4.1.

Goal RC-8: Protect wildlife habitats that support various plants, mammals and other wildlife species.

RC-8.5	Continue to manage and care for all trees located on City property or within City rights-of-way. Provide information to the public on correct tree pruning practices. Encourage residents to properly care for and preserve large and beautiful trees on their private property.	<u>Consistent.</u> New trees located on City property or within City ROW would be installed to City specifications. A public maintenance district will be created to maintain landscaping within the public ROWs. Any tree removal would be conducted in compliance with the City's Tree Preservation Ordinance.
--------	--	--

PUBLIC FACILITIES AND INFRASTRUCTURE

Goal PF-2: Improve access for all Rancho Cucamonga residents to high quality educational opportunities that satisfy each individual's needs, desires, and potential.

PF-2.2	Consider the needs of the school districts that serve Rancho Cucamonga in future planning and development activities.	<u>Consistent.</u> All development will be required to pay applicable school impact fees.
--------	---	---

Goal PF-6: Provide adequate and reliable wastewater collection and treatment facilities to meet current and future needs.

PF-6.2	Consult with the Inland Empire Utilities Agency and the Cucamonga Valley Water District to ensure that the treatment facility has sufficient capacity to meet future wastewater treatment needs.	<u>Consistent.</u> The Inland Empire Utilities Agency and the Cucamonga Valley Water District have been consulted to ensure that the treatment facility has sufficient capacity.
--------	--	--

Goal PF-7: Minimize the volume of solid waste that enters regional landfills and encourage recycling.

PF-7.1	Continue to adopt programs and practices that minimize the amount of materials entering the waste stream. Encourage recycling and composting in all sectors of the community, including recycling of construction and demolition materials, in order to divert items from entering landfills.	<u>Consistent.</u> All new development City code requirements related to diversion and recycling of solid wastes.
PF-7.2	Consult with public agencies and private contractors to ensure adequate refuse collection and disposal facilities are available.	<u>Consistent.</u> There is sufficient capacity to serve the proposed uses.

Public Health and Safety Policies

Goal PS-1: Plan, promote, and demonstrate a readiness to respond and reduce threats to life and property through traditional and innovative emergency services and programs

PS-1.9	Require adequate water supply and fire flow throughout the City to meet fire demand during times of peak domestic water demand through a cooperative relationship with the Cucamonga Valley Water District.	<u>Consistent.</u> CVWD has confirmed that adequate water supply and storage are available to serve allowed development.
--------	---	--



Applicable General Plan Policy/Objective		SPA Consistency Discussion
GOAL PS-3: Protect City residents, businesses, and employees from the potential hazards associated with the use, storage, transport, and disposal of hazardous materials in and through Rancho Cucamonga		
PS-3.2	Identify and regulate businesses that handle hazardous materials in Rancho Cucamonga.	<u>Consistent.</u> Development would comply with existing hazardous material regulations.
Goal PS-4: Provide a high level of public safety services throughout Rancho Cucamonga.		
PS-4.6	Utilize the principles of Crime Prevention Through Environmental Design (CPTED) during the review of development projects.	<u>Consistent.</u> The SPA incorporates CPTED guidelines. Refer to Policy CS-1.7.
Goal PS-5: Minimize the potential damage to structures and loss of life that may result from earthquakes and other seismic hazards.		
PS-5.1	Require geological and geotechnical investigations in areas of potential seismic or geologic hazards as part of the environmental and developmental review process for all structures proposed for human occupancy.	<u>Consistent.</u> A geotechnical feasibility study was conducted for the SPA. Additionally, supplemental geotechnical investigations would be required for future development.
PS-5.5	Continue to incorporate the most recent seismic safety practices into City codes and project review processes.	<u>Consistent.</u> All development will meet the adopted California building codes.
PS-7	Provide adequate and appropriately designed storm drainage and flood control facilities to minimize the risk of flooding.	<u>Consistent.</u> The conceptual storm drain facilities plan concludes that the existing system can handle runoff from the project.
Goal PS-9: Balance economic development and land use objectives in Rancho Cucamonga with the operational needs of LA/Ontario International Airport.		
PS-9.3	Create an appropriate strategy to address proposed development where heights exceed FAR Part 77 standards.	<u>Consistent.</u> The project is consistent with Ontario ALUCP.
Goal PS-10: Maintain good local air quality, and reduce the local contributions of airborne pollutants to the air basin		
PS-10.1	Pursue efforts to reduce air pollution and greenhouse gas emissions by implementing effective energy conservation and efficiency measures and promoting the use of renewable energy (e.g., solar, wind, biomass, cogeneration, and hydroelectric power).	<u>Consistent.</u> Refer to Policy RC-4.1.
PS-10.3	Consider surrounding land uses when locating sensitive receptors such as schools, hospitals, and residential uses so they are not unreasonably exposed to uses that generate pollutants considered detrimental to human health.	<u>Consistent.</u> None of the adjacent properties pose an adverse environmental impact to the site and future occupants.
PS-10.4	Require projects that generate potentially significant levels of air pollutants to incorporate the best available air quality mitigation into the project design, as appropriate.	<u>Consistent.</u> BMPs have been identified to reduce potential air quality impacts to the extent feasible.
PS-10.5	Avoid placing sensitive land uses adjacent to heavy industrial areas.	<u>Consistent.</u> Refer to Policy PS-10.3.
PS-10.6	Implement the policies in the Resource Conservation Chapter that are related to energy resources, energy conservation, and green buildings.	<u>Consistent.</u> Refer to Policy RC-2.1.
Goal PS-11: Reduce the volume of pollutants generated by motorized vehicles		
PS-11.1	Implement the policies in the Community Mobility Chapter to foster a healthy and sustainable community and promote transportation choices other than the private automobile.	<u>Consistent.</u> Refer to CM policies above.
PS-11.2	Minimize vehicle emissions by encouraging alternative land use patterns that reduce the need for automobile trips.	<u>Consistent.</u> Refer to Policies LU-9.5 and CM-2.2.
Goal PS-12: Mitigate against climate change.		
PS-12.2	Encourage renewable energy installation, and facilitate green technology and business and a reduction in community-wide energy consumption.	<u>Consistent.</u> Refer to Policy RC 6.3.

Applicable General Plan Policy/Objective		SPA Consistency Discussion
PS-12.3	Encourage development of transit-oriented and infill development, and encourage a mix of uses that foster walking and alternative transportation.	<u>Consistent.</u> Refer to Policies LU-1.1, LU-1.2, and LU-2.1.
PS-12.4	Provide enhanced bicycling and walking infrastructure, and support public transit, including public bus service, the Metrolink, and the potential for Bus Rapid Transit (BRT).	<u>Consistent.</u> Refer to Policy LU-2.2.
PS-12.7	Support tree planting, planting more vegetation (including native and drought-resistant planting), and preservation of open space.	<u>Consistent.</u> A Tree Removal Permit is required and approximately 5,600 new trees would be planted. The development would result in the loss of a private golf course use. The golf course is not included in the City's calculation of parkland and is not a conservation area. The SPA includes on-site parks, recreation areas, 3rd place nodes, and outdoor gathering spaces to serve future residents, guests, and visitors. These spaces support a healthy, active urban community and encourage a dynamic living environment with integrated open spaces that link people with jobs, and community activities with the surrounding venues.

Goal PS-13: Minimize the impacts of excessive noise levels throughout the community, and adopt appropriate noise level requirements for all land uses

PS-13.1	Consider the compatibility of proposed land uses with the noise environment when preparing or revising community and/or specific plans and when reviewing development proposals. The contour map depicting future noise levels (Figure PS-10) should be used by the City as a guide to land use/noise compatibility.	<u>Consistent.</u> All development will meet adopted California building and Rancho Cucamonga development codes related to interior noise levels. The SPA includes sound wall provisions for parcels adjacent to the rail line.
PS-13.2	Consider noise impacts as part of the development review process, particularly the location of parking, ingress/egress/loading, and refuse collection areas relative to surrounding residential development and other noise-sensitive land uses.	<u>Consistent.</u> Refer to Policy LU-13.1.
PS-13.3	Consider the use of noise barriers or walls to reduce noise levels generated by ground transportation noise sources and industrial sources.	<u>Consistent.</u> Refer to Policy LU-13.1.
PS-13.4	Require that acceptable noise levels are maintained near residences, schools, health care facilities, religious institutions, and other noise sensitive uses in accordance with the Development Code and noise standards contained in the General Plan.	<u>Consistent.</u> Refer to Policy LU-13.1.
PS-13.6	Implement appropriate standard construction noise controls for all construction projects.	<u>Consistent.</u> Mitigation measures are required to be implemented to reduce construction-related noise and vibration.
PS-13.7	Require all exterior noise sources (construction operations, air compressors, pumps, fans, and leaf blowers) to use available noise suppression devices and techniques to bring exterior noise levels down to acceptable levels	<u>Consistent.</u> Refer to Policy PS-13.4.
PS-13.8	Require that Mixed Use structures be designed to account for noise from adjacent uses.	<u>Consistent.</u> Refer to Policy PS-13.1.

Goal PS-14: Minimize the impacts of transportation-related noise.

PS-14.2	Require development that is, or will be, affected by railroad noise to include appropriate measures to minimize adverse noise effects on residents and businesses.	<u>Consistent.</u> A solid wall is proposed along the northern property boundary to reduce noise impacts from the railroad operations. All homes will have interior noise as required by California building codes.
---------	--	---

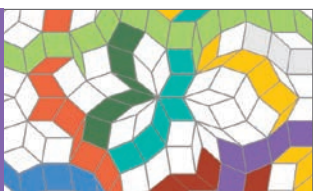

Applicable General Plan Policy/Objective	SPA Consistency Discussion
--	----------------------------

HOUSING

Goal HE-1: Allow and create new opportunities that enable a broad range of housing types, maintain a balanced supply of ownership and rental units, and provide sufficient numbers of dwelling units to accommodate expected new household formations.

HE-1.1	Ensure a wide range of housing alternatives and enable the City to achieve its share of the RHNA through the utilization of land use distribution and development standards to encourage a mix of housing types, including mobile homes and apartments, within a variety of price ranges.	Consistent. The SPA allows the development of up to 3,450 attached and detached medium-high and high-density housing units, Live-Work units, and Shopkeeper units.
--------	---	--

Goal HE-2: Provide housing opportunities that meet the needs of all economic segments of the community including very low, low-, and moderate-income households and special needs groups.

HE-2.1	Protect and expand the range of housing opportunities available by location, price, and tenure to low- and moderate-income households.	Consistent. Refer to Objective HE-1.1.
HE-2.4	Recognize the unique characteristics of elderly and handicapped households and address their special needs.	Consistent. All new development is required to meet the Accessibility requirements of Chapter 11 of the CBC. Transit proximity and pedestrian connections reduce the need for residents to be dependent on personal motor vehicles.
HE-2.4.2	Enforce and regulate the disabled accessibility and adaptability standards contained in Title 24 of the California and Uniform Building Codes as they apply to apartments, condominium, and townhouse projects.	Consistent. Refer to Objective HE-2.4.

Goal HE-3: Provide quality residential environments which contribute to a well-functioning community by ensuring residential development which is not only attractive in design, but which functions to protect the public safety and welfare, and provide benefits to the community.

HE-3.1.2	Continue to evaluate residential projects for safety concerns, including lighting, pedestrian movements, parking lot configuration and design, as well as unit design and orientation, particularly with regard to multi-family development.	Consistent. All projects will be reviewed for CPTED features incorporated in the design. Remote monitoring for the Police Department will be provided.
HE-3.1.3	Promote the development of Crime Prevention Through Environmental Design (CPTED) concepts to evaluate single-family and multi-family residential developments and write CPTED design guidelines to improve the safety of new residential developments.	Consistent. Refer to Policy PS-4.6 and Objective HE-3.1.2



Appendix E Zoning Code Amendment

Section 17.38.070 Rancho Cucamonga IASP Sub-Area 18 Specific Plan

Table 17.38.070-1 Allowed Land Uses and Permit Requirements by Placetype provides the correlation of land use by Placetype to the Base Zoning District in the City's Development Code.

Land use classifications/categories, descriptions, and entitlement/permit requirements are per the City's Development Code unless otherwise defined in this section.

Uses Not Specifically Listed

Uses not specifically listed as permitted or conditionally permitted, but deemed by the Planning Director to be similar to a listed permitted or conditionally permitted use, may be allowed subject to a use determination made by the Planning Director.

A. Shopkeeper and Live/Work Units

In order to encourage businesses that create new jobs while ensuring compatibility with residential units, the following requirements have been established.

Shopkeeper Units

Shopkeeper units are units that include both residential (R-2 occupancy) and non-residential (B-occupancy) mixed occupancy types as defined by the California Building Code. Shopkeeper allows individual occupancy of the non-residential space with separate entries from residence. The non-residential portion of the unit may be leased separately from the residential portion of the unit.

Live/Work Units

Live/Work homes provide non-residence space within the home and are defined by the California Building Code and shall be consistent with the City's Development Code 'Live-Work Facility' allowed use description.

Shopkeeper and Live/Work Homes Permitted Uses

The general types of businesses identified below are allowed within Shopkeeper and Live/Work units:

- Artisan shop.
- General office, business and professional.
- General retail/commercial.
- Restaurant, cafe, or bakery.
- Service commercial.
- Other similar uses as permitted by the master development association and Planning Director, other than those prohibited below.

Persons who do not reside in the unit may be employed at the unit provided that an employee parking space has been approved by the master development association.

Characteristics of Shopkeeper and Live/Work Units

Within the Shopkeeper and Live/Work units, the following operational characteristics shall apply:

- Outside storage of materials or stock in trade is prohibited.
- Signage for the business shall comply with the approved sign program.

Manufacturing, Custom Small Scale

Small scale independent craftsman manufacturing or fabrication of custom-made products. These types of business establishments do not utilize raw materials for their finished products, but rather may utilize semi-finished type of manufactured materials for their custom made-to-order products. Activities can be completed wholly on-site and do not include outdoor storage, wholesale distribution, or similar intensive uses. The uses do not produce odors, noise, vibration, or particulates that would adversely affect uses in the same structure or on a same site.

Table 17.38.070-1. Allowed Land Uses and Permit Requirements by Placetype

Land Use/Zoning District	MH	MH	H	MU	MU	MU	MU
Placetype	VN	CL	UN	T	MU	Rec	MU Overlay*
Residential Uses							
Adult day care home	P	P	P	P	P	P	P
Caretaker housing	C	C	C	C	C	C	C
Dwelling, multi-family	P	P	P	P	P	P	P
Dwelling, second unit ⁽¹⁾	N	N	N	N	N	N	N
Dwelling, single-family	P	P	N	N	N	N	N
Dwelling, two-family	P	P	P	P	P	P	P
Emergency shelter	N	N	N	N	N	N	N
Family day care home, large ⁽¹¹⁾	C	C	C	C	C	C	C
Family day care home, small	P	P	P	P	P	P	P
Guest house	N	N	N	N	N	N	N
Group residential	C	C	C	C	C	C	C
Home occupation ⁽²⁾	P	P	P	P	P	P	P
Live-work facility	C	C	C	N	P	P	P
Shopkeeper ^(*)	P	P	P	N	P	P	P
Manufactured home ⁽³⁾	N	N	N	N	N	N	N
Mobile home park ⁽³⁾	N	N	N	N	N	N	N
Residential care facility	C	C	C	C	C	C	C
Residential care home	P	P	P	N	N	N	N
Single-room occupancy facility	P	P	P	P	P	P	P
Transitional housing	P	P	P	P	P	P	P
Agriculture and Animal-Related Uses							
Agricultural uses	N	N	N	N	N	N	N
Animal keeping, domestic pets ⁽⁴⁾	P	P	P	P	P	P	P
Animal keeping, exotic animals ⁽⁴⁾	C	C	C	C	C	C	C
Animal keeping, insects ⁽⁴⁾	N	N	N	N	N	N	N
Animal keeping, livestock animals ⁽⁴⁾	N	N	N	N	N	N	N
Animal keeping, poultry ⁽⁴⁾	N	N	N	N	N	N	N
Equestrian facility, commercial	N	N	N	N	N	N	N
Equestrian facility, hobby	N	N	N	N	N	N	N
Recreation, Resource Preservation, Open Space, Education, and Public Assembly Uses							
Assembly use	C	C	C	C	C	C	C

P= Permitted
 C= Conditional Use Permit
 N= Not Permitted
 LWC= Live/Work with a Conditional Use Permit***

Table notes:
 (*) Uses Permitted in the MU-Overlay Zone override the underlying Placetype where there is a conflict
 (**) Leasing and New Homes Sales Centers
 (***) Shopkeeper units are those that include both residential (R-2 occupancy) and non-residential (B-occupancy) mixed occupancy types as defined by the California Building Code. The non-residential portion of the unit may be leased separately from the residential portion of the unit.
 (1) See additional second dwelling unit regulations in Chapter 17.100.
 (2) See additional home occupation regulations in Chapter 17.92.
 (3) See additional mobile home regulations in Chapter 17.96.
 (4) See additional animal keeping in Chapter 17.88.
 (5) Utility facilities and infrastructure involving hazardous or volatile gas and/or liquid pipeline development require approval of a CUP.
 (6) See additional adult entertainment businesses in Chapter 17.86. Adult-oriented businesses are not permitted west of Haven Avenue.
 (7) See additional regulations for special regulated uses in the Chapter 17.102.
 (8) See additional regulations for drive-in and drive-through facilities in Chapter 17.90.
 (9) Not permitted within 300 feet of residentially zoned property.
 (10) See additional regulations for wind energy systems in alternative energy systems and facilities in Chapter 17.76.
 (11) Family Day Care Home—Large requires approval of A Large Family Day Care Permit, not a Conditional Use Permit.
 (12) "Wholesale, Storage, and Distribution — Medium" is not permitted on any parcel that is located within, or partly within, five hundred (500) feet of the Foothill Boulevard right-of-way.
 (13) Permitted in Industrial Park and General Industrial zoning districts when proposed in conjunction with "Commercial (Repurposing) — Industrial".
 (14) Maximum square footage for a single user shall not exceed 10,000 square feet.
 (15) The maximum number or rooms for hotels/motels is 200 rooms.

Table 17.38.070-1. Allowed Land Uses and Permit Requirements by Placetype

Land Use/Zoning District	MH	MH	H	MU	MU	MU	MU
Placetype	VN	CL	UN	T	MU	Rec	MU Overlay*
Cemetery/mausoleum	N	N	N	N	N	N	N
Community center/civic use	C	C	C	C	C	P	C
Community garden	C	C	C	N	N	N	N
Convention center	N	N	N	N	N	N	N
Golf course/clubhouse	N	N	N	N	N	N	N
Indoor amusement/entertainment facility	N	N	N	C	C	C	C
Indoor fitness and sports facility - large	N	N	N	C	C	P	C
Indoor fitness and sports facility - small	N	N	N	P	P	P	P
Library and museum	C	C	C	P	P	P	P
Outdoor commercial recreation	N	N	N	C	C	C	C
Park and public plaza	P	P	P	P	P	P	P
Public safety facility	C	C	C	C	C	P	C
Resource-related recreation	P	P	P	P	P	P	P
School, academic (private)	C	C	C	C	C	C	C
School, academic (public)	P	P	P	P	P	P	P
School, college/university (private)	N	N	N	N	P	N	P
School, college/university (public)	N	N	N	N	P	N	P
Schools, specialized education and training/studio	N	N	N	C	C	C	C
Theaters and auditoriums	N	N	N	C	C	C	C
Tutoring center - large ⁽¹⁴⁾	N	N	N	C	C	C	C
Tutoring center - small	N	N	N	P	P	P	P
Utility, Transportation, Public Facility, and Communication Uses							
Broadcasting and recording studios	N	N	N	N	N	N	N
Park and ride facility	N	N	N	P	N	N	N
Parking facility	N	N	N	P	P	P	P
Transit facility	N	N	N	P	N	N	N
Utility facility and infrastructure - fixed based structures ⁽⁵⁾	N	N	N	N	N	N	N
Utility facility and infrastructure - pipelines ⁽⁵⁾	P	P	P	P	P	P	P
Wind energy system - small ⁽¹⁰⁾	N	N	N	N	N	N	N
Retail, Service, and Office Uses							
Adult day care facility	N	N	N	C	C	C	C
Adult-oriented business ⁽⁶⁾	N	N	N	N	N	N	N

P= Permitted
 C= Conditional Use Permit
 N= Not Permitted
 LWC= Live/Work with a Conditional Use Permit***

Table notes:

- (*) Uses Permitted in the MU-Overlay Zone override the underlying Placetype where there is a conflict
- (**) Leasing and New Homes Sales Centers
- (***) Shopkeeper units are those that include both residential (R-2 occupancy) and non-residential (B-occupancy) mixed occupancy types as defined by the California Building Code. The non-residential portion of the unit may be leased separately from the residential portion of the unit.
- (1) See additional second dwelling unit regulations in Chapter 17.100.
- (2) See additional home occupation regulations in Chapter 17.92.
- (3) See additional mobile home regulations in Chapter 17.96.
- (4) See additional animal keeping in Chapter 17.88.
- (5) Utility facilities and infrastructure involving hazardous or volatile gas and/or liquid pipeline development require approval of a CUP.
- (6) See additional adult entertainment businesses in Chapter 17.86. Adult-oriented businesses are not permitted west of Haven Avenue.
- (7) See additional regulations for special regulated uses in the Chapter 17.102.
- (8) See additional regulations for drive-in and drive-through facilities in Chapter 17.90.
- (9) Not permitted within 300 feet of residentially zoned property.
- (10) See additional regulations for wind energy systems and facilities in Chapter 17.76.
- (11) Family Day Care Home—Large requires approval of A Large Family Day Care Permit, not a Conditional Use Permit.
- (12) "Wholesale, Storage, and Distribution — Medium" is not permitted on any parcel that is located within, or partly within, five hundred (500) feet of the Foothill Boulevard right-of-way.
- (13) Permitted in Industrial Park and General Industrial zoning districts when proposed in conjunction with "Commercial (Repurposing) — Industrial".
- (14) Maximum square footage for a single user shall not exceed 10,000 square feet.
- (15) The maximum number or rooms for hotels/motels is 200 rooms.

Table 17.38.070-1. Allowed Land Uses and Permit Requirements by Placetype

Land Use/Zoning District	MH	MH	H	MU	MU	MU	MU
Placetype	VN	CL	UN	T	MU	Rec	MU Overlay*
Alcoholic beverage sales	N	N	N	C	C	C	C
Ambulance service	N	N	N	N	N	N	N
Animal sales and grooming	N	N	N	P	P	P	P
Art, antique, collectable shop ⁽¹³⁾	LWC	LWC	LWC	P	P	P	P
Artisan shop ⁽¹³⁾	LWC	LWC	LWC	P	P	P	P
Bail bonds	N	N	N	N	N	N	N
Banks and financial services	N	N	N	C	C	C	C
Bar/nightclub	N	N	N	C	C	C	C
Bed and breakfast inn	N	N	N	N	N	N	N
Building materials store and yard	N	N	N	N	N	N	N
Business support services	N	N	N	P	P	P	P
Call center	N	N	N	N	N	N	N
Card room	N	N	N	N	N	N	N
Check cashing business ⁽⁷⁾	N	N	N	P	P	P	P
Child day care facility/center	N	N	N	C	C	C	C
Consignment store	N	N	N	C	C	C	C
Convenience store	N	N	N	P	P	P	P
Crematory services ⁽⁷⁾	N	N	N	N	N	N	N
Drive-in and drive-through sales and service ⁽⁸⁾	N	N	N	N	N	N	N
Equipment sales and rental	N	N	N	N	N	N	N
Feed and tack store	N	N	N	N	N	N	N
Furniture, furnishing, and appliance store ⁽¹⁴⁾	N	N	N	C	P	N	P
Garden center/plant nursery ⁽¹⁴⁾	C	C	C	C	C	C	C
Grocery store/supermarket ⁽¹⁴⁾	N	N	N	P	P	P	P
Gun sales	N	N	N	N	N	N	N
Hookah shop	N	N	N	C	C	C	C
Home improvement supply store ⁽¹⁴⁾	N	N	N	C	C	N	C
Hotel and motel ⁽¹⁵⁾	N	N	N	C	C	C	C
Internet cafe	N	N	N	P	P	P	P
Kennel, commercial	N	N	N	N	N	N	N
Liquor store	N	N	N	C	C	C	C
Maintenance and repair, small equipment	N	N	N	P	P	P	P

P= Permitted
 C= Conditional Use Permit
 N= Not Permitted
 LWC= Live/Work with a Conditional Use Permit***

Table notes:
 (*) Uses Permitted in the MU-Overlay Zone override the underlying Placetype where there is a conflict
 (**) Leasing and New Homes Sales Centers
 (***) Shopkeeper units are those that include both residential (R-2 occupancy) and non-residential (B-occupancy) mixed occupancy types as defined by the California Building Code. The non-residential portion of the unit may be leased separately from the residential portion of the unit.
 (1) See additional second dwelling unit regulations in Chapter 17.100.
 (2) See additional home occupation regulations in Chapter 17.92.
 (3) See additional mobile home regulations in Chapter 17.96.
 (4) See additional animal keeping in Chapter 17.88.
 (5) Utility facilities and infrastructure involving hazardous or volatile gas and/or liquid pipeline development require approval of a CUP.
 (6) See additional adult entertainment businesses in Chapter 17.86. Adult-oriented businesses are not permitted west of Haven Avenue.
 (7) See additional regulations for special regulated uses in the Chapter 17.102.
 (8) See additional regulations for drive-In and drive-through facilities in Chapter 17.90.
 (9) Not permitted within 300 feet of residentially zoned property.
 (10) See additional regulations for wind energy systems in alternative energy systems and facilities in Chapter 17.76.
 (11) Family Day Care Home—Large requires approval of A Large Family Day Care Permit, not a Conditional Use Permit.
 (12) "Wholesale, Storage, and Distribution — Medium" is not permitted on any parcel that is located within, or partly within, five hundred (500) feet of the Foothill Boulevard right-of-way.
 (13) Permitted in Industrial Park and General Industrial zoning districts when proposed in conjunction with "Commercial (Repurposing) — Industrial".
 (14) Maximum square footage for a single user shall not exceed 10,000 square feet.
 (15) The maximum number or rooms for hotels/motels is 200 rooms.

Table 17.38.070-1. Allowed Land Uses and Permit Requirements by Placetype

Land Use/Zoning District	MH	MH	H	MU	MU	MU	MU
Placetype	VN	CL	UN	T	MU	Rec	MU Overlay*
Massage establishment	N	N	N	C	C	C	C
Medical marijuana dispensary	N	N	N	N	N	N	N
Medical services, extended care	C	C	C	C	C	C	C
Medical services, general	N	N	N	P	P	P	P
Medical services, hospitals	N	N	N	N	N	N	N
Mobile hot food truck	N	N	N	N	N	N	N
Mortuary/funeral home	N	N	N	N	N	N	N
Office, business and professional(**)	LWC	LWC	LWC	P	P	P	P
Office, accessory	N	N	N	P	P	P	P
Pawnshop ⁽⁷⁾	N	N	N	N	N	N	N
Personal services	N	N	N	P	P	P	P
Restaurant, no liquor service	N	N	N	P	P	P	P
Restaurant, beer and wine	N	N	N	P	P	P	P
Restaurant, full liquor service	N	N	N	C	C	C	C
Retail, accessory	N	N	N	P	P	P	P
Retail, general	LWC	LWC	LWC	P	P	P	P
Retail, warehouse club	N	N	N	N	N	N	N
Secondhand dealer	N	N	N	P	P	P	P
Shooting range	N	N	N	N	N	N	N
Smoke shop ⁽⁷⁾	N	N	N	N	N	N	N
Specialty food store ⁽¹³⁾	N	N	N	P	P	P	P
Tattoo shop ⁽⁷⁾	N	N	N	N	C	N	C
Thrift store ⁽⁷⁾	N	N	N	N	N	N	N
Veterinary facility	N	N	N	C	C	C	C
Automobile and Vehicle Uses							
Auto vehicle dismantling	N	N	N	N	N	N	N
Auto and vehicle sales and rental	N	N	N	N	N	N	N
Auto and vehicle sales, auto broker	N	N	N	N	N	N	N
Auto and vehicle sales, wholesale	N	N	N	N	N	N	N
Auto and vehicle storage	N	N	N	N	N	N	N
Auto parts sales	N	N	N	N	N	N	N
Car washing and detailing	N	N	N	N	N	N	N

P= Permitted

C= Conditional Use Permit

N= Not Permitted

LWC= Live/Work with a Conditional Use Permit***

Table notes:

(*) Uses Permitted in the MU-Overlay Zone override the underlying Placetype where there is a conflict

(**) Leasing and New Homes Sales Centers

(***) Shopkeeper units are those that include both residential (R-2 occupancy) and non-residential (B-occupancy) mixed occupancy types as defined by the California Building Code. The non-residential portion of the unit may be leased separately from the residential portion of the unit.

(1) See additional second dwelling unit regulations in Chapter 17.100.

(2) See additional home occupation regulations in Chapter 17.92.

(3) See additional mobile home regulations in Chapter 17.96.

(4) See additional animal keeping in Chapter 17.88.

(5) Utility facilities and infrastructure involving hazardous or volatile gas and/or liquid pipeline development require approval of a CUP.

(6) See additional adult entertainment businesses in Chapter 17.86. Adult-oriented businesses are not permitted west of Haven Avenue.

(7) See additional regulations for special regulated uses in the Chapter 17.102.

(8) See additional regulations for drive-in and drive-through facilities in Chapter 17.90.

(9) Not permitted within 300 feet of residentially zoned property.

(10) See additional regulations for wind energy systems in alternative energy systems and facilities in Chapter 17.76.

(11) Family Day Care Home—Large requires approval of A Large Family Day Care Permit, not a Conditional Use Permit.

(12) "Wholesale, Storage, and Distribution — Medium" is not permitted on any parcel that is located within, or partly within, five hundred (500) feet of the Foothill Boulevard right-of-way.

(13) Permitted in Industrial Park and General Industrial zoning districts when proposed in conjunction with "Commercial (Repurposing) — Industrial".

(14) Maximum square footage for a single user shall not exceed 10,000 square feet.

(15) The maximum number of rooms for hotels/motels is 200 rooms.

Table 17.38.070-1. Allowed Land Uses and Permit Requirements by Placetype

Land Use/Zoning District	MH	MH	H	MU	MU	MU	MU
Placetype	VN	CL	UN	T	MU	Rec	MU Overlay*
Recreational vehicle storage	N	N	N	N	N	N	N
Service stations	N	N	N	N	N	N	N
Vehicle services, major	N	N	N	N	N	N	N
Vehicle services, minor	N	N	N	N	N	N	N
Industrial, Manufacturing, and Processing Uses							
Fuel storage and distribution	N	N	N	N	N	N	N
Manufacturing, custom small-scale	LWC	LWC	LWC	P	P	N	P
Manufacturing, heavy	N	N	N	N	N	N	N
Manufacturing, heavy-minimum impact	N	N	N	N	N	N	N
Manufacturing, light	N	N	N	N	N	N	N
Manufacturing, medium ⁽⁹⁾	N	N	N	N	N	N	N
Microbrewery	LWC	LWC	LWC	P	P	N	P
Printing and publishing	N	N	N	P	P	P	P
Recycling facility, collection	N	N	N	N	N	N	N
Recycling facility, processing	N	N	N	N	N	N	N
Recycling facility, scrap and dismantling facility	N	N	N	N	N	N	N
Research and development	N	N	N	N	N	N	N
Storage, personal storage facility	N	N	N	N	N	N	N
Storage warehouse	N	N	N	N	N	N	N
Storage yard	N	N	N	N	N	N	N
Wholesale, storage, and distribution - heavy	N	N	N	N	N	N	N
Wholesale, storage, and distribution - light	N	N	N	N	N	N	N
Wholesale, storage, and distribution - medium ⁽⁹⁾⁽¹²⁾	N	N	N	N	N	N	N
<p>P= Permitted C= Conditional Use Permit N= Not Permitted LWC= Live/Work with a Conditional Use Permit***</p> <p>Table notes: (*) Uses Permitted in the MU-Overlay Zone override the underlying Placetype where there is a conflict (**) Leasing and New Homes Sales Centers (***) Shopkeeper units are those that include both residential (R-2 occupancy) and non-residential (B-occupancy) mixed occupancy types as defined by the California Building Code. The non-residential portion of the unit may be leased separately from the residential portion of the unit. (1) See additional second dwelling unit regulations in Chapter 17.100. (2) See additional home occupation regulations in Chapter 17.92. (3) See additional mobile home regulations in Chapter 17.96. (4) See additional animal keeping in Chapter 17.88. (5) Utility facilities and infrastructure involving hazardous or volatile gas and/or liquid pipeline development require approval of a CUP. (6) See additional adult entertainment businesses in Chapter 17.86. Adult-oriented businesses are not permitted west of Haven Avenue. (7) See additional regulations for special regulated uses in the Chapter 17.102. (8) See additional regulations for drive-In and drive-through facilities in Chapter 17.90. (9) Not permitted within 300 feet of residentially zoned property. (10) See additional regulations for wind energy systems in alternative energy systems and facilities in Chapter 17.76. (11) Family Day Care Home—Large requires approval of A Large Family Day Care Permit, not a Conditional Use Permit. (12) "Wholesale, Storage, and Distribution — Medium" is not permitted on any parcel that is located within, or partly within, five hundred (500) feet of the Foothill Boulevard right-of-way. (13) Permitted in Industrial Park and General Industrial zoning districts when proposed in conjunction with "Commercial (Repurposing) — Industrial". (14) Maximum square footage for a single user shall not exceed 10,000 square feet. (15) The maximum number or rooms for hotels/motels is 200 rooms.</p>							

Plan. A full copy of all adopted Specific Plan documents (and any adopted amendments thereto) shall be kept in the Planning Department and in the City Clerk's office.

- A. **Etiwanda Specific Plan (ESP).** The Etiwanda Specific Plan was adopted by the City Council in 1983. It encompasses over 3,000 acres located in the northeast corner of the city and is roughly bounded by the I-15 to the southeast, the City's Sphere of Influence to the north, the Victoria Planned Community to the west, and the city's industrial area to the south. Etiwanda can be described as a rural community, characterized by large land parcels, eucalyptus tree rows, remnants of citrus groves and vineyards, stone curbs, and other elements that convey its unique and historic sense of place. The primary purpose of the Specific Plan is to ensure the continued rural character of this portion of the city. Please refer to the adopted Etiwanda Specific Plan maintained by the Planning Department and City Clerk for comprehensive details.
- B. **North Etiwanda Specific Plan (NESP).** The North Etiwanda Specific Plan was adopted by the City Council in 1992. It includes 6,850 acres located just north of the Etiwanda Specific Plan. A portion of the Specific Plan area lies outside the city and outside the Sphere of Influence. Open space is the most prominent feature of the North Etiwanda area, which comprises a gently sloping alluvial fan and chaparral habitat situated on the lower slopes of the foothills. Drainage courses throughout the North Etiwanda area support a variety of tree species, including oak, sycamore, and walnut, among others. A unique feature of the area is a freshwater marsh, approximately 11 acres in size, located in the northwestern portion of the area. Open space is expected to remain a prominent feature even after development occurs. The Specific Plan builds upon the unique character and charm of the Etiwanda Specific Plan area by providing a land use pattern that extends the low-density character of Old Etiwanda into the North Etiwanda area. The primary purpose of the Specific Plan is to preserve rural area with large parcels, dense landscape, and historic properties. Please refer to the adopted North Etiwanda Specific Plan maintained by the Planning Department and City Clerk for comprehensive details.
- C. **Empire Lakes Specific Plan (ELSP).** The Empire Lakes Specific Plan was adopted in 1994. It includes 380 acres within the previously adopted Industrial Specific Plan Area as Sub-Area 18. The primary purpose of this subsequent Specific Plan is to provide for a broader mix of land uses than was originally permitted within the Industrial Area Specific Plan. The plan was expanded to include such uses as recreational, hotel/conference center, retail, restaurant, and entertainment, as well as office, research and development, and light industrial uses. ~~These uses are intended to surround the existing 18-hole golf course.~~ A subsequent amendment to further expand the use list included ~~limited~~ multi-unit residential development to maximize potential use of the Metrolink Station near Milliken Avenue.

Section 17.114.030 Planned Community Descriptions

The Planned Communities listed below have been adopted by the City of Rancho Cucamonga and designated on the Zoning Map as Planned Community (PD) with a specific reference number to each adopted plan. This Section provides a reference to each adopted Planned Community, along with a summary of the unique land use and development standards applicable to each individual Planned Community. A full copy of all adopted Planned Community documents (and any adopted amendments thereto) shall be kept in the Planning Department and in the City Clerk's office.

TABLE 17.36.020-1 DEVELOPMENT STANDARDS FOR MIXED USE SITES

Mixed Use Sites	Land Use Mix				Average Density Range
	Residential	Commercial	Office	Public/Quasi Public	
Victoria Gardens/Victoria Arbors	21–36%	20–41%		5–12%	4–14 du/ac
Town Center (Foothill Boulevard and Haven Avenue)	25–35%	10–15%	30–50%	0–10%	14 du/ac
Terra Vista	12–15%		85–87%		30 du/ac
Foothill Boulevard between Hermosa Avenue and Center Avenue	0–62%	0–100%			20 du/ac
Foothill Boulevard between Archibald Avenue and Hellman Avenue	67–70%	30–33%			15–30 du/ac
Foothill Boulevard at Helms Avenue and Hampshire Street	30–40%	60–70%			30 du/ac
Foothill Boulevard and Mayten Avenue	26–50%	40–60%	6–10%	4%	24–30 du/ac
Rancho Cucamonga IASP PA4-11	11–22%	15–25%	40–60%	7.5%	28 du/ac
Foothill Boulevard and Deer Creek Channel	70–75%	25–30%			14 du/ac
Haven Avenue and Church Street Site	0–100%		0–100%		8–14 du/ac
Western Gateway (Bear Gulch Area)	30–50%	50–70%			14 du/ac
Foothill Boulevard and Cucamonga Channel Site	0–100%		0–100%		8–14 du/ac
Historic Alta Loma (Amethyst Site)	0–100%		0–100%	16.3-20.0%	14–24 du/ac
Rancho Cucamonga IASP PA1	72.6-77.5%		0.1-7.4%		19.7-25.7

Section 17.36.030 Development Standards for Commercial and Office Zoning Districts

- A. **Purpose and Applicability.** The purpose of this Section is to establish minimum development standards that are unique to development projects within the Commercial and Office Zoning Districts. Development standards in this Section apply to all land designated on the Zoning Map within the Commercial and Office Zoning Districts.
- B. **Commercial and Office Districts Described.** As identified in Chapter 17.26 (Establishment of Zoning Districts), the city includes six (6) Commercial and Office Zoning Districts: